

HOFMANN & VRATNY — SC MILLING CUTTERS EN

TITANIUM

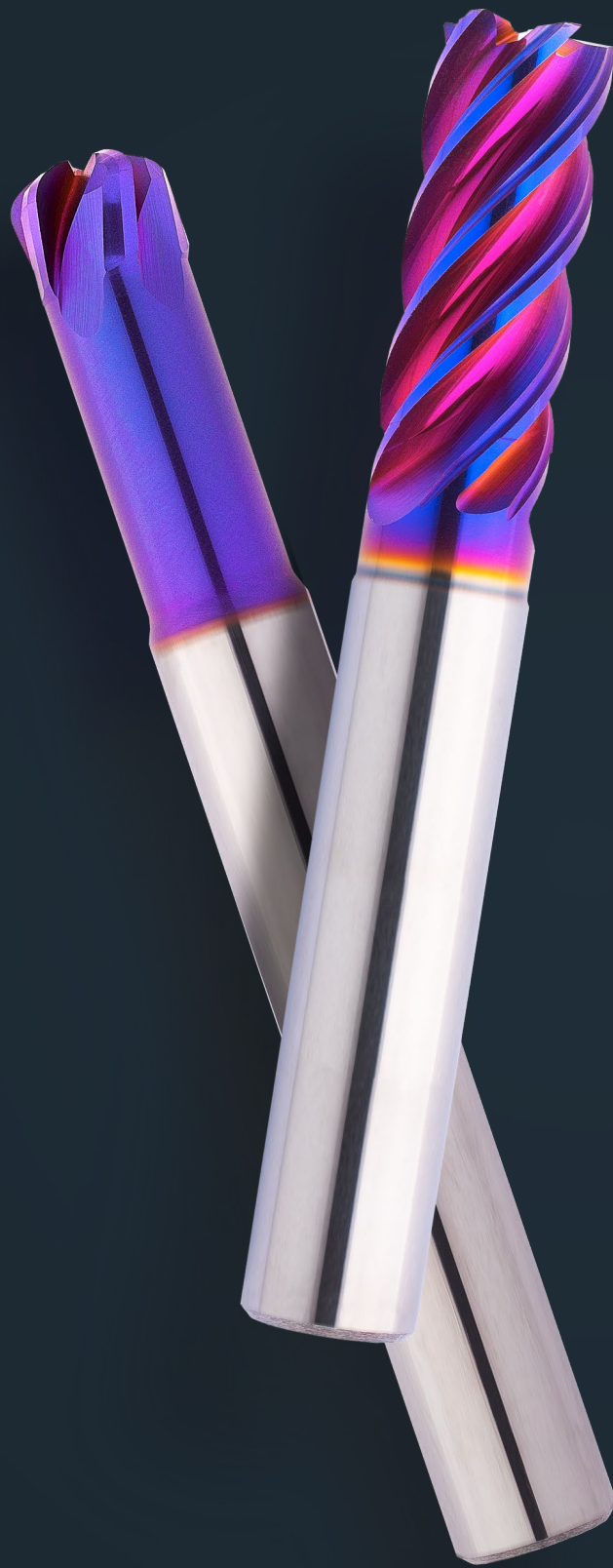

Expert

2025



THE RIGHT TOOL. AT ALL TIMES.

Welcome to Hofmann & Vratny. As leading manufacturer of solid carbide tools, we enable companies throughout the world to manufacture their products.

Every day, our strong team works on our collective goal of producing the best tools in the world. Companies from the medical industry, semi-conductor industry, machine and plant construction, aviation, aerospace engineering and, not least, the automotive industry have been using our milling cutters for decades now. Quality – Made in Bavaria.

The success of our company is built on innovation, a culture of cooperation, open interaction with high respect and many years of successful and trustful collaboration with our business partners. You can always count on us, our tools and our irreplaceable drive to shape the future of the industry together. To us, that means shaping tomorrow.

Andreas Vratny

Zdenek Vratny

Marius Heinemann-Grüder



TITANIUM

49
YEARS OF
EXPERIENCE

2 Mio.
TOOLS
PRODUCED
EVERY YEAR

MILLING CUTTERS



**MADE IN
BAVARIA**

PROVEN QUALITY

DRILLS



**MADE IN
CZECHIA**

PROVEN QUALITY

- Manufacturer of solid carbide cutting tools for a wide range of materials
- Founded 1976
- 2 locations in Bavaria and 1 location in Czechia
- Headquarters with milling cutter production in Aßling near Munich
- Regrinding center in Nuremberg
- Location with drill production in Ivančice near Brno





TITANIUM

3
PRODUCTION
SITES

49
YEARS OF
EXPERIENCE

140
MOTIVATED
EMPLOYEES

THE EXPERTS FOR TITANIUM.

Our Expert-line milling cutters for titanium sets new standards, especially in the fields of medicine and aerospace. Titanium has become increasingly important throughout the industry, and machining is one of the most demanding processing operations for the material. That's why we focus exclusively on high-end materials and innovative development approaches for our Expert-line titanium milling cutters.

There are many reasons why titanium is challenging to machine:

- | EXTREMELY HIGH LOAD ON THE CUTTING EDGE
- | SHAPE OF THE CHIPS
- | THE CHIPS' TENDENCY TO ADHERE
- | THE MILLING CUTTER IS EXPOSED TO VERY HIGH TEMPERATURES
- | TOUGHNESS OF THE MATERIAL
- | LOW EXPANSION DUE TO HEAT OF TITANIUM

TITANIUM MACHINING PROCESS. A CHALLENGE.

We have tailored the tools precisely to all titanium alloys to take account of the difficulties involved in the titanium machining process. The milling cutters feature a special carbide developed especially for titanium, polished chip spaces, sharp cutting edges and a particularly smooth and unique multi-layer coating. It was just as critical to find the right geometries in development, which are designed for maximum process reliability and performance.

K201692 | PERFORMMAKER Z5 2XD AFVX

HELIX

Face for dipping, ramping and retracting in the helix. Specifically designed for high loads.

BLADES

Unequal tooth pitch of the cutting edges for particularly smooth running when trimming and during full slot milling.

CORNER RADIUS

Optimised corner radius to increase tool lifetime.

HELICAL PITCH

Dynamic helical pitch for exceptional performance.

CHIP SPACES

Specially developed chip spaces to ensure smooth chip removal, even in the full slot application.



TABLE OF CONTENTS

PERFORMMAKER | END MILL CUTTER

K201687 Performmaker Z4 1.5xD AFVX	8
K201688 Performmaker Z4 1.5xD AFVX	10
K201692 Performmaker Z5 2xD AFVX	12
K201693 Performmaker Z5 2xD AFVX	14



FORMMAKER | TORUS CUTTER

K202423 Formmaker Z4 2xD AFVX	16
K202424 Formmaker Z4 2xD AFVX	20



BLADEMAKER | FACE TORUS CUTTER

K207033 Blademaker Z2-5 0.5xD short AFVX	24
K207038 Blademaker Z2-5 0.5xD long AFVX	26



ROWMAKER | FULL RADIUS CUTTER

K203383 Rowmaker Z4 1xD short AFVX	28
K203388 Rowmaker Z4 1xD long AFVX	30



EXPLANATION	32
MATERIAL OVERVIEW	34
TECHNICAL FORMULAS	35
GENERAL TERMS OF SALE	36
DISCOVER OUR H&V PRODUCT RANGE	39

Cooling	
Tolerance	e8
Coating	AlphaFusion Violet X

Strategy	ETC	HPC				
Application						
Features	HA	≠		1,5xD	R	

- Unequal tooth pitch combined with variable helical pitch for smooth running
 - Highly polished chip space for safe chip evacuation
 - Reinforced face for process reliable, helical diving
-
- For roughing and finishing, up to 1xD full slot

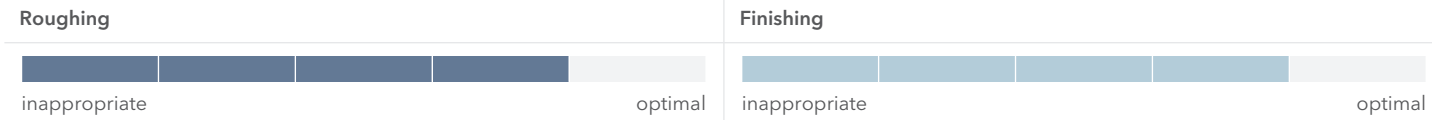
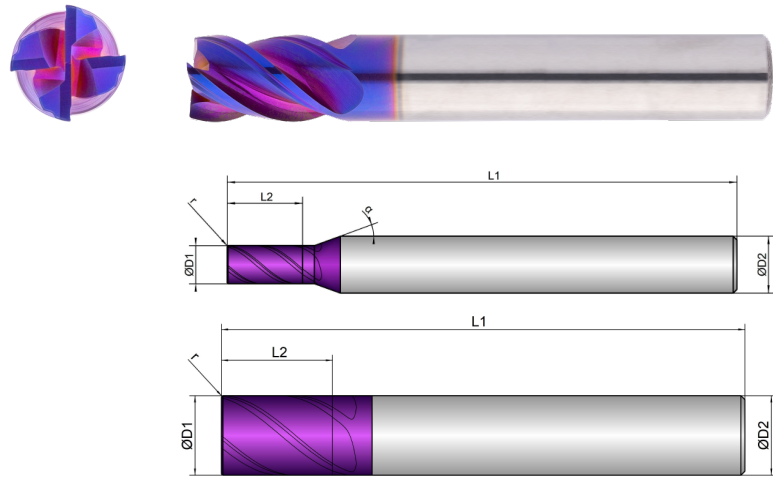

	D1	L2	L1	D2	z	r	α
K201687							
	mm \varnothing	mm	mm	mm \varnothing	#	mm	°
4	4.0	8.0	54.0	6.0	4	0.10	12
5	5.0	9.0	54.0	6.0	4	0.20	12
6	6.0	10.0	54.0	6.0	4	0.20	0
8	8.0	12.0	58.0	8.0	4	0.20	0
10	10.0	14.0	66.0	10.0	4	0.20	0
12	12.0	16.0	73.0	12.0	4	0.20	0
16	16.0	22.0	82.0	16.0	4	0.30	0
20	20.0	26.0	92.0	20.0	4	0.30	0

Dimension	Ø4		Ø5		Ø6		Ø8		Ø10		Ø12	
Infeed in mm	ae=1xD	ae=0.3xD	ae=1xD	ae=0.3xD	ae=1xD	ae=0.3xD	ae=1xD	ae=0.3xD	ae=1xD	ae=0.3xD	ae=1xD	ae=0.3xD
Application												

Material	Strength (N/mm ²)	Feed (mm/Z)	Strength (N/mm ²)												
			fz	fz	fz	fz	fz	fz	fz	fz	fz	fz	fz		
TITANIUM			Vc (m/min)												
2.1-2.2	pure; alloyed	<1000	80	0.018	0.025	0.022	0.029	0.026	0.037	0.032	0.047	0.039	0.059	0.045	0.07
2.3	alloyed	<1400	60	0.015	0.02	0.018	0.024	0.022	0.032	0.028	0.042	0.034	0.054	0.04	0.065

Dimension	Ø16		Ø20	
Infeed in mm	ae=1xD	ae=0.3xD	ae=1xD	ae=0.3xD
Application				

Material	Strength (N/mm ²)	Feed (mm/Z)	Strength (N/mm ²)				
			fz	fz	fz	fz	
TITANIUM			Vc (m/min)				
2.1-2.2	pure; alloyed	<1000	80	0.055	0.08	0.065	0.1
2.3	alloyed	<1400	60	0.05	0.075	0.06	0.09

Cooling	
Tolerance	e8
Coating	AlphaFusion Violet X

Strategy	ETC	HPC			
Application					
Features	HB	≠		1,5xD	R

- Unequal tooth pitch combined with variable helical pitch for smooth running
- Highly polished chip space for safe chip evacuation
- Reinforced face for process reliable, helical diving

■ For roughing and finishing, up to 1xD full slot

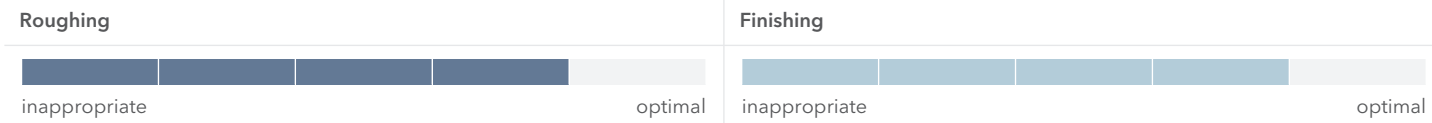
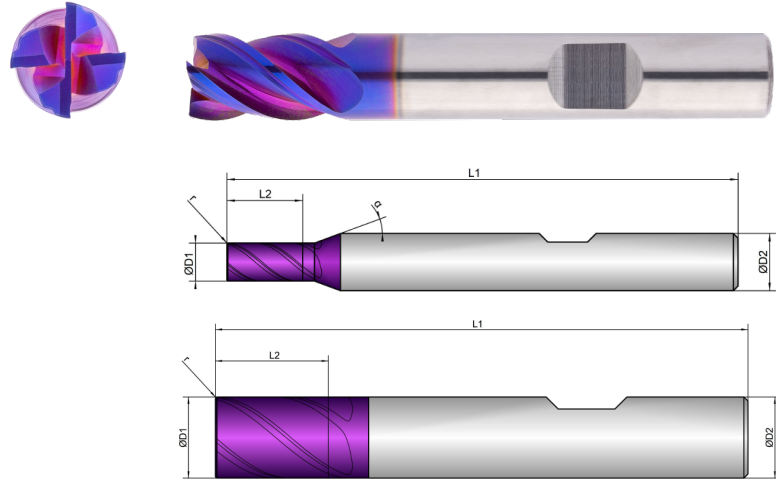

	D1	L2	L1	D2	z	r		α
K201688	 mm \varnothing	 mm	 mm	 mm \varnothing	 #	 mm	 °	 °
4	4.0	8.0	54.0	6.0	4	0.10	40	12
5	5.0	9.0	54.0	6.0	4	0.20	40	12
6	6.0	10.0	54.0	6.0	4	0.20	40	
8	8.0	12.0	58.0	8.0	4	0.20	40	
10	10.0	14.0	66.0	10.0	4	0.20	40	
12	12.0	16.0	73.0	12.0	4	0.20	40	
16	16.0	22.0	82.0	16.0	4	0.30	40	
20	20.0	26.0	92.0	20.0	4	0.30	40	

Dimension	Ø4		Ø5		Ø6		Ø8		Ø10		Ø12	
Infeed in mm	ae= 1xD	ae= 0.3xD	ae= 1xD	ae= 0.3xD	ae= 1xD	ae= 0.3xD	ae= 1xD	ae= 0.3xD	ae= 1xD	ae= 0.3xD	ae= 1xD	ae= 0.3xD
Application												

Material	Strength (N/mm ²)	Feed (mm/Z)	fz	fz	fz	fz	fz	fz	fz	fz	fz	fz	fz		
TITANIUM		Vc (m/min)													
2.1-2.2	pure; alloyed	<1000	80	0.018	0.025	0.022	0.029	0.026	0.037	0.032	0.047	0.039	0.059	0.045	0.07
2.3	alloyed	<1400	60	0.015	0.02	0.018	0.024	0.022	0.032	0.028	0.042	0.034	0.054	0.04	0.065

Dimension	Ø16		Ø20	
Infeed in mm	ae= 1xD	ae= 0.3xD	ae= 1xD	ae= 0.3xD
Application				

Material	Strength (N/mm ²)	Feed (mm/Z)	fz	fz	fz	fz	
TITANIUM		Vc (m/min)					
2.1-2.2	pure; alloyed	<1000	80	0.055	0.08	0.065	0.1
2.3	alloyed	<1400	60	0.05	0.075	0.06	0.09

Cooling	
Tolerance	e8
Coating	AlphaFusion Violet X

Strategy	ETC	HPC				
Application						
Features	HA	≠	2xD			

- Unequal tooth pitch combined with variable helical pitch for smooth running
- Highly polished chip space for safe chip evacuation
- Reinforced face for process reliable, helical diving

■ For roughing and finishing

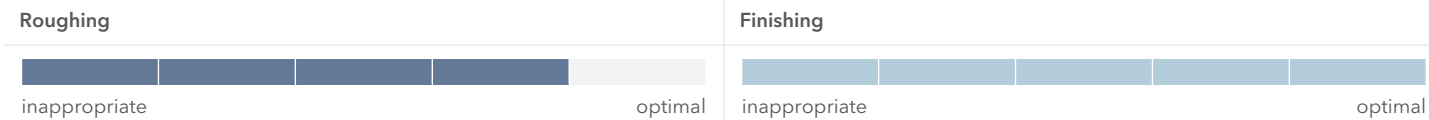
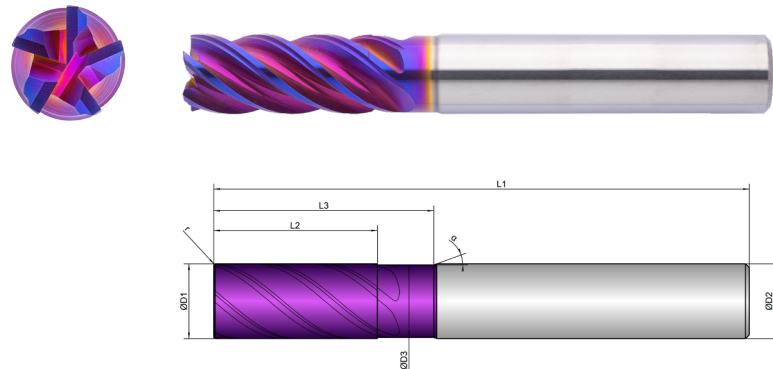

	D1	D3	L2	L3	L1	D2	z	r		α
K201692	mm \varnothing	mm \varnothing	mm	mm	mm	mm \varnothing	#	mm	°	°
6	6.0	5.8	13.0	19.0	57.0	6.0	5	0.10	40	20
8	8.0	7.7	19.0	25.0	63.0	8.0	5	0.20	40	20
10	10.0	9.7	22.0	30.0	72.0	10.0	5	0.20	40	20
12	12.0	11.6	26.0	36.0	83.0	12.0	5	0.20	40	20
16	16.0	15.5	36.0	42.0	92.0	16.0	5	0.30	40	20
20	20.0	19.5	41.0	52.0	104.0	20.0	5	0.30	40	20

Dimension	Ø6		Ø8		Ø10		Ø12		Ø16		Ø20	
Infeed in mm	ae=1xD	ae=0.3xD	ae=1xD	ae=0.3xD	ae=1xD	ae=0.3xD	ae=1xD	ae=0.3xD	ae=1xD	ae=0.3xD	ae=1xD	ae=0.3xD
Application												

Material	Strength (N/mm ²)	Feed (mm/Z)	fz	fz	fz	fz	fz	fz	fz	fz	fz	fz	fz
TITANIUM		Vc (m/min)											
2.1-2.2 pure; alloyed	<1000	80	0.026	0.037	0.032	0.047	0.039	0.059	0.045	0.07	0.055	0.08	0.065
2.3 alloyed	<1400	60	0.022	0.032	0.028	0.042	0.034	0.054	0.04	0.065	0.05	0.075	0.06

STILL CAN'T FIND A SUITABLE MILLING CUTTER?

No problem - simply customize an existing tool. Using our configurator for special milling cutters, you can customize existing tools to your needs in an instant or create your own tools based on predefined types.



WE WILL RESPOND TO ALL REQUESTS SUBMITTED VIA THE CONFIGURATOR WITHIN ONE WORKING DAY AT THE LATEST

Cooling	
Tolerance	e8
Coating	AlphaFusion Violet X

Strategy	ETC	HPC		
Application				
Features	HB	≠	2xD	

- Unequal tooth pitch combined with variable helical pitch for smooth running
- Highly polished chip space for safe chip evacuation
- Reinforced face for process reliable, helical diving

■ For roughing and finishing

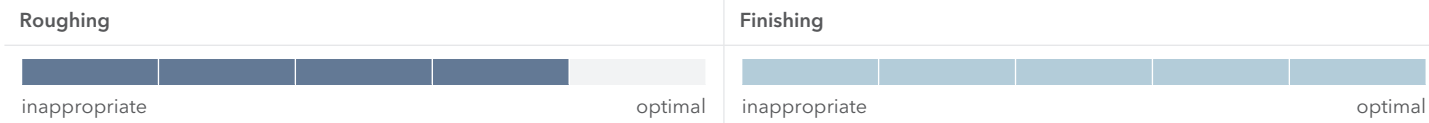
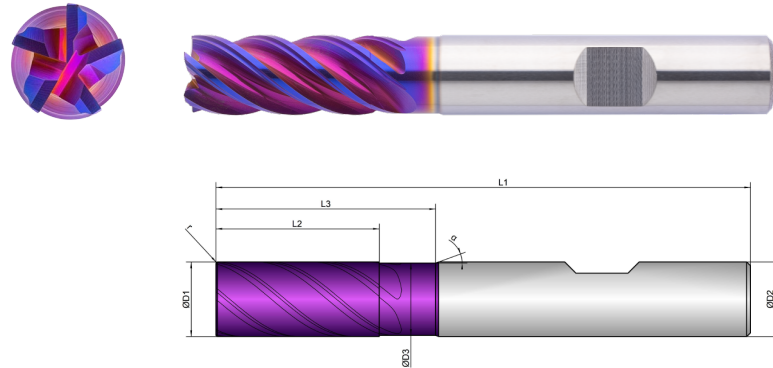

	D1	D3	L2	L3	L1	D2	z	r	α
K201693									
	mm ∅	mm ∅	mm	mm	mm	mm ∅	#	mm	°
6	6.0	5.8	13.0	19.0	57.0	6.0	5	0.10	40
8	8.0	7.7	19.0	25.0	63.0	8.0	5	0.20	40
10	10.0	9.7	22.0	30.0	72.0	10.0	5	0.20	40
12	12.0	11.6	26.0	36.0	83.0	12.0	5	0.20	40
16	16.0	15.5	36.0	42.0	92.0	16.0	5	0.30	40
20	20.0	19.5	41.0	52.0	104.0	20.0	5	0.30	40

Dimension	∅6		∅8		∅10		∅12		∅16		∅20				
Infeed in mm	ae=1xD	ae=0.3xD	ae=1xD	ae=0.3xD	ae=1xD	ae=0.3xD	ae=1xD	ae=0.3xD	ae=1xD	ae=0.3xD	ae=1xD	ae=0.3xD			
Application															
Material	TITANIUM														
Strength (N/mm ²)	Vc (m/min)														
2.1-2.2	pure; alloyed	<1000	80	0.026	0.037	0.032	0.047	0.039	0.059	0.045	0.07	0.055	0.08	0.065	0.1
2.3	alloyed	<1400	60	0.022	0.032	0.028	0.042	0.034	0.054	0.04	0.065	0.05	0.075	0.06	0.09

Cooling	
Tolerance	e8
Coating	AlphaFusion Violet X

Strategy	ETC	HSC	HPC	
Application				
Features	HA	≠	2xD	

- Unequal tooth pitch combined with variable helical pitch for smooth running
- Highly polished chip space for safe chip evacuation
- Reinforced face for process reliable, helical diving

- For roughing and finishing, up to 1,5xD full slot
- Multipass milling of 3D contours

- Radius tolerance $r \leq 1.5 \text{ mm}$: $\pm 0.003 \text{ mm}$
- Radius tolerance $r > 1.5 \text{ mm}$: $\pm 0.005 \text{ mm}$

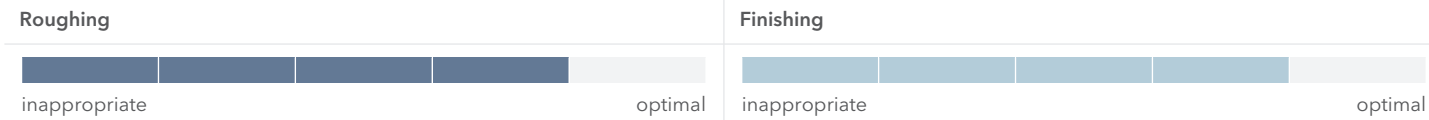
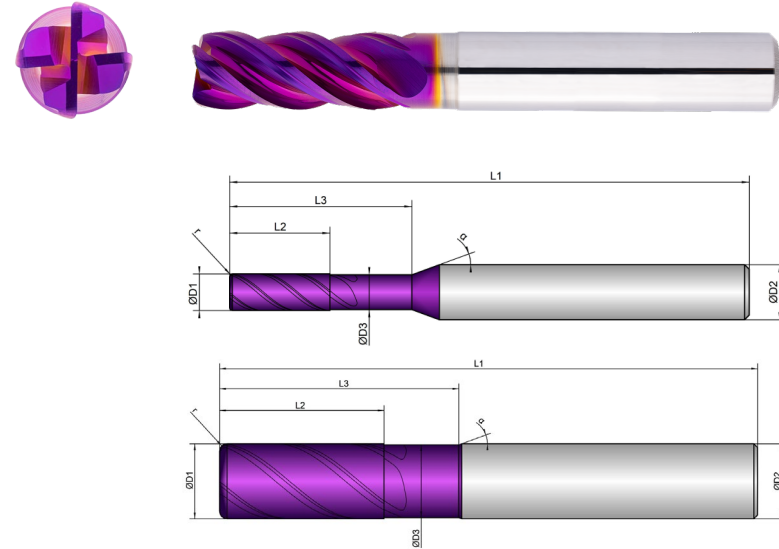

K202423	D1 mm ø	D3 mm ø	L2 mm	L3 mm	L1 mm	D2 mm ø	z #	r mm		α °
4/0,3	4.0	3.8	11.0	20.0	57.0	6.0	4	0.30	40	20
4/1	4.0	3.8	11.0	20.0	57.0	6.0	4	1.00	40	20
5/0,3	5.0	4.8	13.0	20.0	57.0	6.0	4	0.30	40	20
5/1	5.0	4.8	13.0	20.0	57.0	6.0	4	1.00	40	20
6/0,3	6.0	5.8	13.0	20.0	57.0	6.0	4	0.30	40	20
6/1	6.0	5.8	13.0	20.0	57.0	6.0	4	1.00	40	20
8/0,3	8.0	7.7	19.0	25.0	63.0	8.0	4	0.30	39.85	20
8/1	8.0	7.7	19.0	25.0	63.0	8.0	4	1.00	40	20
10/0,3	10.0	9.7	22.0	32.0	72.0	10.0	4	0.30	40	20

K202423	D1 mm ø	D3 mm ø	L2 mm	L3 mm	L1 mm	D2 mm ø	z #	r mm		α °
10/1	10.0	9.7	22.0	32.0	72.0	10.0	4	1.00	40	20
10/2	10.0	9.7	22.0	32.0	72.0	10.0	4	2.00	40	20
12/0,3	12.0	11.6	26.0	38.0	83.0	12.0	4	0.30	40	20
12/1	12.0	11.6	26.0	38.0	83.0	12.0	4	1.00	40	20
12/2	12.0	11.6	26.0	38.0	83.0	12.0	4	2.00	40	20
12/3	12.0	11.6	26.0	38.0	83.0	12.0	4	3.00	40	20
16/0,3	16.0	15.5	32.0	44.0	92.0	16.0	4	0.30	40	20
16/1	16.0	15.5	32.0	44.0	92.0	16.0	4	1.00	40	20
16/2	16.0	15.5	32.0	44.0	92.0	16.0	4	2.00	40	20
16/3	16.0	15.5	32.0	44.0	92.0	16.0	4	3.00	40	20
16/4	16.0	15.5	32.0	44.0	92.0	16.0	4	4.00	40	20
20/0,3	20.0	19.5	38.0	54.0	104.0	20.0	4	0.30	40	20
20/1	20.0	19.5	38.0	54.0	104.0	20.0	4	1.00	40	20
20/2	20.0	19.5	38.0	54.0	104.0	20.0	4	2.00	40	20

			Ø4			Ø5			Ø6			Ø8			
Material	Strength (N/mm²)	Dimension	Infeed in mm			Application			Feed (mm/Z)			Vc (m/min)			
			ae=1xD	ae=0.3xD	ae=0.04xD	ap=1xD	ap=2xD	ap=0.04xD	fz	fz	fz	fz	fz	fz	
T	TITANIUM		fz												
2.1-2.2	pure; alloyed	<1000	80	0.018	0.018	0.025	0.022	0.022	0.029	0.026	0.03	0.037	0.032	0.037	0.047
2.3	alloyed	<1400	60	0.015	0.015	0.02	0.018	0.018	0.024	0.022	0.025	0.032	0.028	0.032	0.042

			Ø10			Ø12			Ø16			Ø20			
Material	Strength (N/mm²)	Dimension	Infeed in mm			Application			Feed (mm/Z)			Vc (m/min)			
			ae=1xD	ae=0.3xD	ae=0.04xD	ap=1xD	ap=2xD	ap=0.04xD	fz	fz	fz	fz	fz	fz	
T	TITANIUM		fz												
2.1-2.2	pure; alloyed	<1000	80	0.039	0.049	0.059	0.045	0.06	0.07	0.055	0.07	0.08	0.065	0.09	0.1
2.3	alloyed	<1400	60	0.034	0.044	0.054	0.04	0.055	0.065	0.05	0.065	0.075	0.06	0.08	0.09

ADVICE | By using multipass milling the maximum infeed (ae, ap) is 0.5x corner radius!

Cooling	
Tolerance	e8
Coating	AlphaFusion Violet X

Strategy	ETC	HSC	HPC	
Application				
Features	HB	≠	2xD	



- Unequal tooth pitch combined with variable helical pitch for smooth running
 - Highly polished chip space for safe chip evacuation
 - Reinforced face for process reliable, helical diving
-
- For roughing and finishing, up to 1,5xD full slot
 - Multipass milling of 3D contours
-
- Radius tolerance $r \leq 1.5$ mm: ± 0.003 mm
 - Radius tolerance $r > 1.5$ mm: ± 0.005 mm

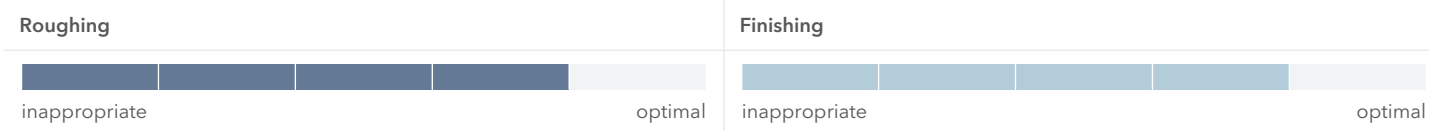
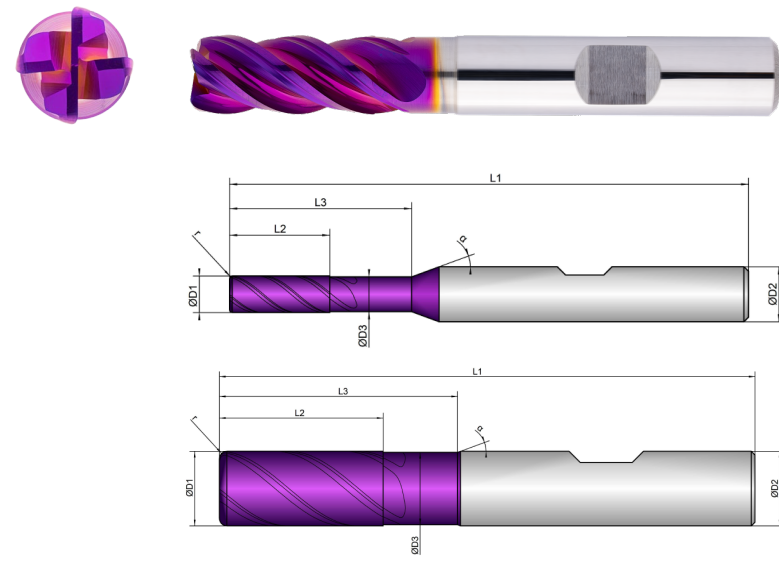

K202424	D1 mm ø	D3 mm ø	L2 mm	L3 mm	L1 mm	D2 mm ø	z #	r mm		α °
4/0,3	4.0	3.8	11.0	20.0	57.0	6.0	4	0.30	40	20
4/1	4.0	3.8	11.0	20.0	57.0	6.0	4	1.00	40	20
5/0,3	5.0	4.8	13.0	20.0	57.0	6.0	4	0.30	40	20
5/1	5.0	4.8	13.0	20.0	57.0	6.0	4	1.00	40	20
6/0,3	6.0	5.8	13.0	20.0	57.0	6.0	4	0.30	40	20
6/1	6.0	5.8	13.0	20.0	57.0	6.0	4	1.00	40	20
8/0,3	8.0	7.7	19.0	25.0	63.0	8.0	4	0.30	40	20
8/1	8.0	7.7	19.0	25.0	63.0	8.0	4	1.00	40	20
10/0,3	10.0	9.7	22.0	32.0	72.0	10.0	4	0.30	40	20

K202424	D1 mm ø	D3 mm ø	L2 mm	L3 mm	L1 mm	D2 mm ø	z #	r mm		α °
10/1	10.0	9.7	22.0	32.0	72.0	10.0	4	1.00	40	20
10/2	10.0	9.7	22.0	32.0	72.0	10.0	4	2.00	40	20
12/0,3	12.0	11.6	26.0	38.0	83.0	12.0	4	0.30	40	20
12/1	12.0	11.6	26.0	38.0	83.0	12.0	4	1.00	40	20
12/2	12.0	11.6	26.0	38.0	83.0	12.0	4	2.00	40	20
12/3	12.0	11.6	26.0	38.0	83.0	12.0	4	3.00	40	20
16/0,3	16.0	15.5	32.0	44.0	92.0	16.0	4	0.30	40	20
16/1	16.0	15.5	32.0	44.0	92.0	16.0	4	1.00	40	20
16/2	16.0	15.5	32.0	44.0	92.0	16.0	4	2.00	40	20
16/3	16.0	15.5	32.0	44.0	92.0	16.0	4	3.00	40	20
16/4	16.0	15.5	32.0	44.0	92.0	16.0	4	4.00	40	20
20/0,3	20.0	19.5	38.0	54.0	104.0	20.0	4	0.30	40	20
20/1	20.0	19.5	38.0	54.0	104.0	20.0	4	1.00	40	20
20/2	20.0	19.5	38.0	54.0	104.0	20.0	4	2.00	40	20

			Ø4			Ø5			Ø6			Ø8			
Material	Strength (N/mm²)	Dimension	Infeed in mm			Application			Feed (mm/Z)			Vc (m/min)			
			ae=1xD	ae=0.3xD	ae=0.04xD	ap=1xD	ap=2xD	ap=0.04xD	fz	fz	fz	fz	fz	fz	
T	TITANIUM		fz												
2.1-2.2	pure; alloyed	<1000	80	0.018	0.018	0.025	0.022	0.022	0.029	0.026	0.03	0.037	0.032	0.037	0.047
2.3	Titanium. alloyed	<1400	60	0.015	0.015	0.02	0.018	0.018	0.024	0.022	0.025	0.032	0.028	0.032	0.042

			Ø10			Ø12			Ø16			Ø20			
Material	Strength (N/mm²)	Dimension	Infeed in mm			Application			Feed (mm/Z)			Vc (m/min)			
			ae=1xD	ae=0.3xD	ae=0.04xD	ap=1xD	ap=2xD	ap=0.04xD	fz	fz	fz	fz	fz	fz	
T	TITANIUM		fz												
2.1-2.2	pure; alloyed	<1000	80	0.039	0.049	0.059	0.045	0.06	0.07	0.055	0.07	0.08	0.065	0.09	0.1
2.3	alloyed	<1400	60	0.034	0.044	0.054	0.04	0.055	0.065	0.05	0.065	0.075	0.06	0.08	0.09

ADVICE | By using multipass milling the maximum infeed (ae, ap) is 0.5x corner radius!

Cooling	
Tolerance	h9
Coating	AlphaFusion Violet X

Strategy	HSC									
Application										
Features	HA	≠		0,5xD	R					



- Geometry with tangential transitions for HSC milling
- Highly polished chip space for safe chip evacuation

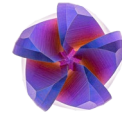

- Long version for deeper cavities
- For roughing and finishing under HSC conditions

- Check programming radius and ap max. according to the variant table

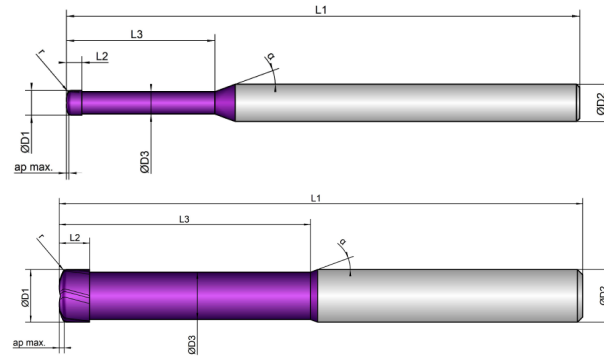

Roughing



Finishing



	D1	D3	L2	L3	L1	D2	z				α
K207038	mm \varnothing	mm \varnothing	mm	mm	mm	mm \varnothing	#	mm	mm max	°	°
2	2.0	1.7	1.5	18.0	75.0	6.0	2	0.3	0.15	15	20
3	3.0	2.7	1.5	20.0	75.0	6.0	2	0.3	0.20	15	20
4	4.0	3.6	2.5	24.0	83.0	6.0	2	0.5	0.25	15	20
5	5.0	4.6	3.5	28.0	100.0	6.0	4	0.5	0.35	15	20
6	6.0	5.2	3.5	28.0	100.0	6.0	4	1.0	0.40	15	20
8	8.0	7.0	4.8	40.0	100.0	8.0	5	1.5	0.50	15	20
10	10.0	9.0	5.8	48.0	100.0	10.0	5	2.0	0.75	15	20
12	12.0	11.0	6.8	56.0	119.0	12.0	5	2.0	0.80	15	20
16	16.0	14.5	8.8	65.0	150.0	16.0	5	2.5	1.00	15	20

Dimension	Ø2	Ø3	Ø4	Ø5	Ø6	Ø8	Ø10	Ø12	Ø16
Infeed in mm	ae= 1xD ap _{max} = 0.15mm	ae= 1xD ap _{max} = 0.2mm	ae= 1xD ap _{max} = 0.25mm	ae= 1xD ap _{max} = 0.35mm	ae= 1xD ap _{max} = 0.4mm	ae= 1xD ap _{max} = 0.5mm	ae= 1xD ap _{max} = 0.75mm	ae= 1xD ap _{max} = 0.8mm	ae= 1xD ap _{max} = 1.0mm
Application									

T	Material	Strength (N/mm ²)	Feed (mm/Z)									
			Feed (mm/Z)	fz	fz	fz	fz	fz	fz	fz	fz	fz
Vc (m/min)												
2.1-2.2	TITANIUM	<1000	95	0.017	0.033	0.06	0.07	0.08	0.1	0.13	0.16	0.18
2.3	alloyed	<1400	80	0.015	0.03	0.055	0.065	0.075	0.09	0.12	0.15	0.17

Cooling	
Tolerance	f8
Coating	AlphaFusion Violet X

Strategy	HSC	
Application		
Features	HA 1xD	

- Highly polished chip space for safe chip evacuation
- For roughing and finishing
- 4 cutting edges to the center
- Radius tolerance $r \leq 2$ mm: ± 0.003 mm
- Radius tolerance $r > 2$ mm: ± 0.005 mm

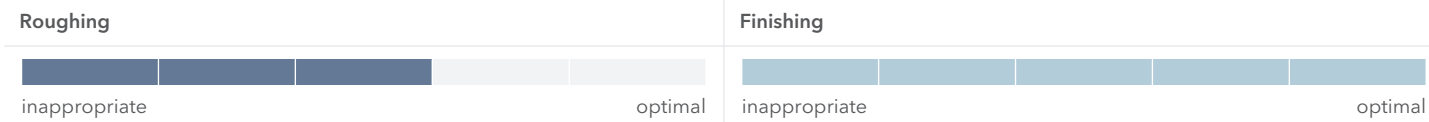
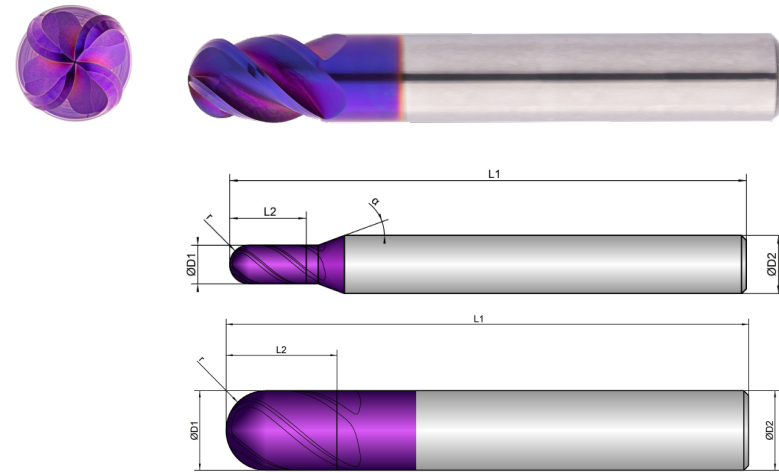

K203383	D1 mm ø	L2 mm	L1 mm	D2 mm ø	z #	r mm	 °	 °
2	2.0	4.0	54.0	6.0	4	1.00	40	12
3	3.0	5.0	54.0	6.0	4	1.50	40	12
4	4.0	8.0	54.0	6.0	4	2.00	40	12
5	5.0	9.0	54.0	6.0	4	2.50	40	12
6	6.0	10.0	54.0	6.0	4	3.00	40	
8	8.0	12.0	58.0	8.0	4	4.00	40	
10	10.0	14.0	66.0	10.0	4	5.00	40	
12	12.0	16.0	73.0	12.0	4	6.00	40	
16	16.0	20.0	82.0	16.0	4	8.00	40	

Dimension	Ø2	Ø3	Ø4	Ø5	Ø6	Ø8	Ø10	Ø12	Ø16
Infeed in mm	ae= 0.05xD ap= 0.05xD	ae= 0.05xD ap= 0.05xD	ae= 0.05xD ap= 0.05xD	ae= 0.05xD ap= 0.05xD	ae= 0.05xD ap= 0.05xD	ae= 0.05xD ap= 0.05xD	ae= 0.05xD ap= 0.05xD	ae= 0.05xD ap= 0.05xD	ae= 0.05xD ap= 0.05xD
Application									

Material	Strength (N/mm ²)	Feed (mm/Z)	fz	fz	fz	fz	fz	fz	fz	fz	fz
TITANIUM		Vc (m/min)									
2.1-2.2 pure; alloyed	<1000	65	0.013	0.015	0.018	0.023	0.03	0.036	0.048	0.06	0.07
2.3 alloyed	<1400	60	0.011	0.013	0.015	0.02	0.026	0.032	0.044	0.055	0.065

STILL CAN'T FIND A SUITABLE MILLING CUTTER?

No problem - simply customize an existing tool. Using our configurator for special milling cutters, you can customize existing tools to your needs in an instant or create your own tools based on predefined types.



WE WILL RESPOND TO ALL REQUESTS SUBMITTED VIA THE CONFIGURATOR WITHIN ONE WORKING DAY AT THE LATEST



Cooling	
Tolerance	f8
Coating	AlphaFusion Violet X

Strategy	HSC	
Application		
Features	HA 1xD	

Highly polished chip space for safe chip evacuation

Long version for deeper cavities
For roughing and finishing

4 cutting edges to the center
Radius tolerance $r \leq 2$ mm: ± 0.003 mm
Radius tolerance $r > 2$ mm: ± 0.005 mm

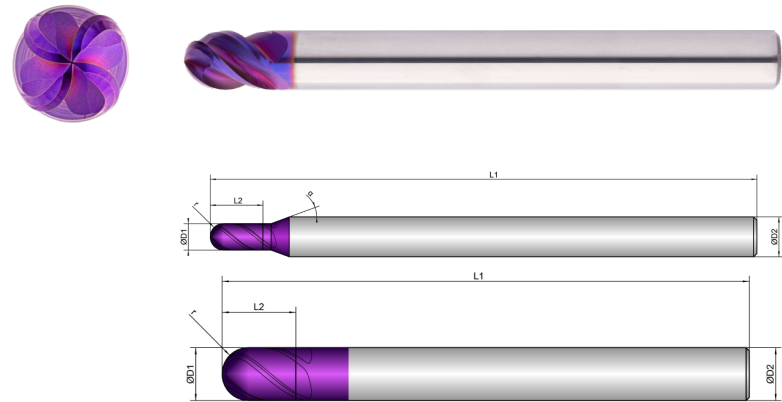

Roughing



Finishing



	D1	L2	L1	D2	z	r		α
K203388	 mm \varnothing	 mm	 mm	 mm \varnothing	 #	 mm	 °	 °
2	2.0	4.0	83.0	6.0	4	1.00	40	12
3	3.0	5.0	83.0	6.0	4	1.50	40	12
4	4.0	8.0	83.0	6.0	4	2.00	40	12
5	5.0	9.0	83.0	6.0	4	2.50	40	12
6	6.0	10.0	83.0	6.0	4	3.00	40	
8	8.0	12.0	100.0	8.0	4	4.00	40	
10	10.0	14.0	100.0	10.0	4	5.00	40	
12	12.0	16.0	100.0	12.0	4	6.00	40	
16	16.0	20.0	100.0	16.0	4	8.00	40	

Dimension	Ø2	Ø3	Ø4	Ø5	Ø6	Ø8	Ø10	Ø12	Ø16
Infeed in mm	ae= 0.05xD ap= 0.05xD	ae= 0.05xD ap= 0.05xD	ae= 0.05xD ap= 0.05xD	ae= 0.05xD ap= 0.05xD	ae= 0.05xD ap= 0.05xD	ae= 0.05xD ap= 0.05xD	ae= 0.05xD ap= 0.05xD	ae= 0.05xD ap= 0.05xD	ae= 0.05xD ap= 0.05xD
Application									

Material	Strength (N/mm ²)	Feed (mm/Z)	Vc (m/min)								
			fz	fz	fz	fz	fz	fz	fz	fz	
TITANIUM											
2.1-2.2 pure; alloyed	<1000	55	0.013	0.015	0.018	0.023	0.03	0.036	0.048	0.06	0.07
2.3 alloyed	<1400	50	0.011	0.013	0.015	0.02	0.026	0.032	0.044	0.055	0.065

EXPLANATION

APPLICATIONS

Multipass milling	Trimming	Deburring	Engraving
Corner rounding	Full slot milling	Forward and backward deburring	

COOLINGS

Air-cooling	Dry machining	Oil cooling	Cooling Lubricant
Minimum quantity lubrication			

FEATURES

0,5xD	1xD	1,5xD	2xD
2,5xD	3xD	3,5xD	4xD
5xD	Center cutting	Non-center cutting	Without Weldon
With Weldon	Internal cooling	Dynamic helical pitch	Chip breaker
Unequal tooth pitch	Roughing teeth	Helical immersion	Feed directions x,y
Feed directions x, y, z	Feed directions x, y, (z)	Corner radius	Corner bevel
Sharp edged			

STRATEGY

Extended Trochoidal Cutting	High Performance Cutting	High Speed Cutting	Multi Task Cutting
Universal Machining			

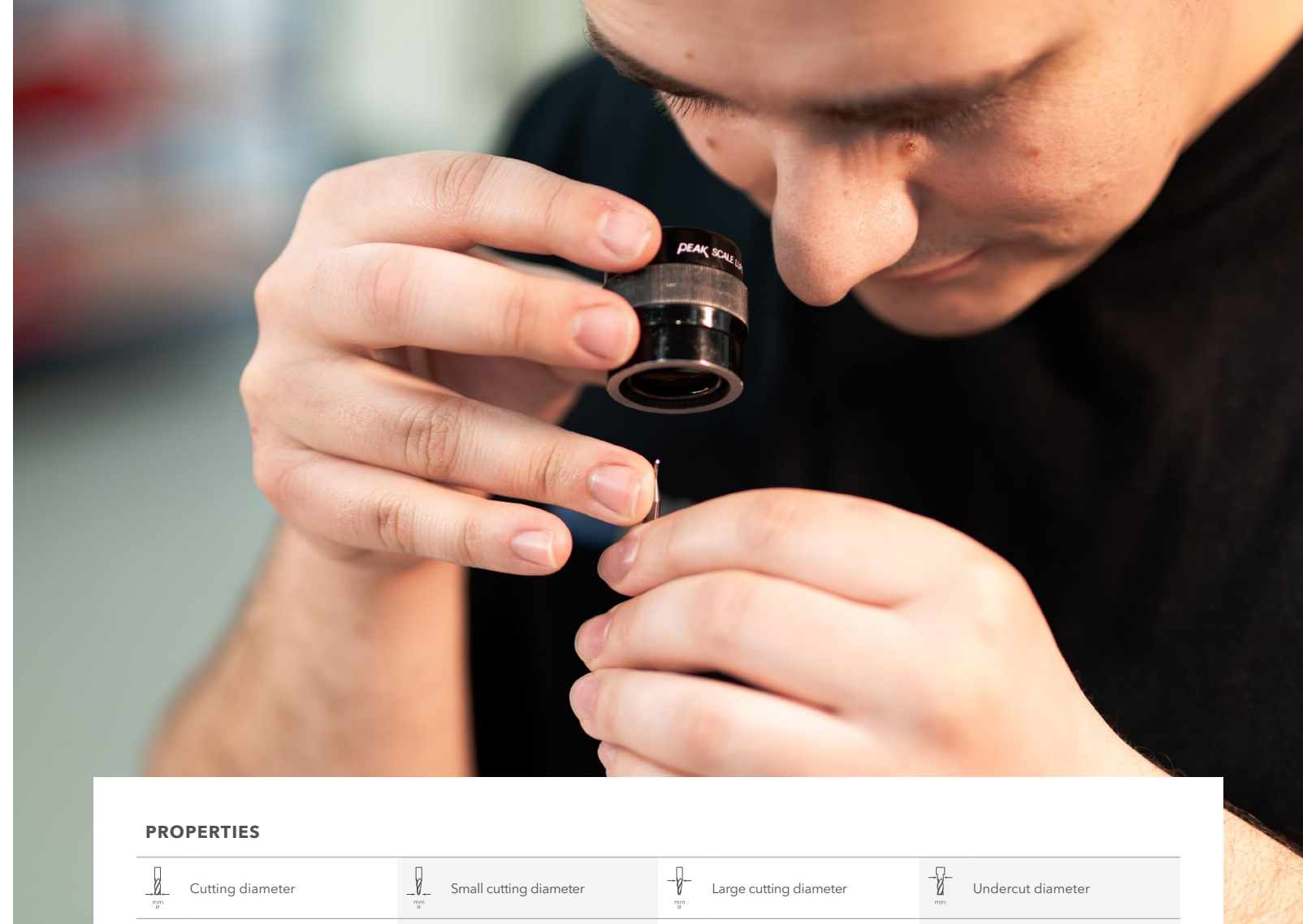

PROPERTIES

Cutting diameter	Small cutting diameter	Large cutting diameter	Undercut diameter
Cutting length	Total bevel length	Undercut length	Total length
Shank diameter	Number of teeth	Corner radius	Corner bevel
Programming radius	Maximum cutting depth	Helical angle	Alpha angle

APPLICATION TABLE

The values given in the application table are only guidelines. These values are largely dependent on the machining situation and application.

FIGURES

All technical drawings and photographs are given as an example. The product may deviate from the original in terms of colour and dimensions.

S 2.1 TITANIUM | commercially pure <600 N/mm²

Materialnumber	Germany DIN	Europe EN	France AFNOR	Great Britain BS	Italy UNI	Sweden SIS	Spain UNE	Japan JIS	USA AISI
3.7024	Ti 99,8								
3.7025	Ti 99,8	Titan Grade 1	AIR:9182T35	2 TA 1					R 50250
3.7034	Ti 99,7								
3.7035	Ti 99,7	Titan Grade 2	AIR:9182T40	2 TA 2-1					R 50400
3.7036	SG-Ti 2								
3.7054	Ti 99,6								
3.7055	Ti-99,6	Titan Grade 3	AIR:9182T50	TA 3					R 50550
3.7064									
3.7065	Ti-99,5	Titan Grade 4	AIR:9182T60	2 TA 6-9					R 50700

S 2.2 TITANIUM | alloyed <1000 N/mm²

Materialnumber	Germany DIN	Europe EN	France AFNOR	Great Britain BS	Italy UNI	Sweden SIS	Spain UNE	Japan JIS	USA AISI
3.7105	TiNi 0,8 Mo 0,3	Titan Grade 12							
3.7114	TiAl 5 Sn 2								
3.7115	TiAl 5 Sn 2,5	Titan Grade 6	T-A 5 E						Ti 5 Al-2,5 Sn
3.7124	Ti Cu 2								
3.7195	TiAl 3 V 2,5	Titan Grade 9							
3.7225	Ti 1 Pd	Titan Grade 11		TP 1					R 52250
3.7235	Ti 2 Pd	Titan Grade 7							T 52400
3.7255	Ti 3 Pd								

S 2.3 TITANIUM | alloyed <1400 N/mm²

Materialnumber	Germany DIN	Europe EN	France AFNOR	Great Britain BS	Italy UNI	Sweden SIS	Spain UNE	Japan JIS	USA AISI
3.7110	TiAl 5 Fe 2,5								
3.7144	TiAl 6 Sn 2 Zr 4 Mo 2								
3.7145	TiAl 6 Sn2 Zr4 Mo2 Si								R 54620
3.7154	TiAl 6 Zr 5								
3.7155	TiAl 6 ZrMo 0,5			TA 43				TC 4	
3.7164	TiAl 6 V 4-LN	Titan Grade 5							R 56400
3.7165	TiAl 6 V4	Titan Grade 5	T-A 6 V	TA 10-13					
3.7174	TiAl 6 V 6 Sn 2-LN								
3.7175	TiAl 6 V 6 Sn 2								R 56620
3.7184	TiAl 4 Mo 4 Sn 2-LN								
3.7185	TiAl 4 Mo 4 Sn 2			TA 45-51					
3.7194	TiAl 5 V2,5								



Technical formulas

Calculate cutting speed (m/min)

$$V_c = \frac{D \cdot \pi \cdot n}{1000}$$

Calculate rotational speed (rpm)

$$n = \frac{V_c \cdot 1000}{D \cdot \pi}$$

Calculate feed rate (mm/min)

$$V_f = n \cdot z \cdot f_z$$

Calculate feed per tooth (mm/number of teeth)

$$f_z = \frac{V_f}{n \cdot z}$$

Calculate chip removal rate (cm³/min)

$$Q = \frac{a_p \cdot a_e \cdot V_f}{1000}$$

Calculate average chip thickness (mm)

$$h_m = f_z \cdot \frac{\sqrt{a_e}}{D}$$

Explanation of terms

V _c	Cutting speed	in m/min
n	Rotational speed	in rpm
V _f	Feed rate	in mm/min
F _z	Feed per tooth	in mm/number of teeth
z	Number of teeth (cutting)	
a _p	Depth of cut	in mm
a _e	Width of cut	in mm
h _m	Average chip thickness	in mm
Q	Chip removal rate	in cm³/min
D	Diameter of tool	in mm

GENERAL TERMS OF SALE

§ 1 SCOPE

1. These General Terms of Sale apply to all business relationships between Hofmann & Vratny OHG (hereinafter referred to as “Hofmann & Vratny”) and its customers (hereinafter referred to individually as the “Ordering Party” and collectively as the “Ordering Parties”).

2. These General Terms of Sale only apply to Ordering Parties that are entrepreneurs pursuant to §§ 14 and 310 para. 1 of the BGB (Civil Code of Germany), legal entities under public law, and/or special funds under public law.

3. The scope of application of these General Terms of Sale includes, but is not limited to, contracts regarding the sale and/or delivery of chattels (hereinafter referred to as “Goods”) regardless of whether they are produced by Hofmann & Vratny or procured from suppliers (§§ 433 and 651 of the BGB). Unless agreed upon otherwise, the version of these General Terms of Sale applicable at the time the Ordering Party places an order and in any case the most recent version of these General Terms of Sale provided to the Ordering Party in writing in the form of a master agreement also shall apply to similar contracts made at a later date without Hofmann & Vratny being required to make reference to them in every individual case.

4. These General Terms of Sale shall apply exclusively. These General Terms of Sale also shall apply if and when Hofmann & Vratny executes a delivery without reservation despite having knowledge of the Ordering Party’s terms of sale which contradict or deviate from these General Terms of Sale. Any of the Ordering Party’s terms of sale which contradict or deviate from these General Terms of Sale shall become part of a contract only with Hofmann & Vratny’s express prior consent. Such requirement to consent shall apply in any case even, for example, if the Ordering Party refers to its terms of sale as part of an order placement and Hofmann & Vratny does not object explicitly to such terms.

5. If Hofmann & Vratny and the Ordering Party have entered into any individual agreements, such individual agreements shall prevail over these General Terms of Sale. The content of such individual agreements only can be substantiated by a written contract or by written confirmation from Hofmann & Vratny. Individual agreements (e.g., outline delivery contracts, quality assurance agreements) and information provided in Hofmann & Vratny’s order confirmation shall prevail over these General Terms of Sale. In case of doubt, commercial clauses shall be interpreted based on the Incoterms® issued by the International Chamber of Commerce in Paris (ICC) and applicable at the time the contract is entered into.

6. All of the Ordering Party’s legal declarations and notifications made with regard to the contract (e.g., in connection with deadlines or notices of defects, rescission, or reduction) shall be made in writing to be effective. In the context of these General Terms of Sale, in writing shall include written and text forms (e.g., letters, e-mails, faxes). Legal requirements regarding form and other verifications including, but not limited to, cases of doubt regarding the legitimation of the notifying party shall remain unaffected.

7. All references to applicable laws shall be for the purpose of clarification only. Unless amended in or excluded expressly from these General Terms of Sale, laws shall apply even without express reference.

§ 2 OFFERS AND ACCEPTANCE

1. All offers made by Hofmann & Vratny shall be subject to change and shall be non-binding including if and when images, drawings, technical documentation, calculations, analyses, other documents or product descriptions of whatever nature (hereinafter referred to as “Documents”) are provided to the Ordering Party if the proprietary rights and copyrights to those Documents are retained by Hofmann & Vratny.

2. All orders for Goods placed by the Ordering Party shall constitute binding offers. Unless stated otherwise in the respective order, Hofmann & Vratny shall be entitled to accept an offer within two weeks after receipt of said offer.

3. Hofmann & Vratny shall accept offers in writing (e.g., in the form of an order confirmation) or by delivering the respective Goods to the Ordering Party.

4. All proprietary rights and copyrights to Documents shall remain with Hofmann & Vratny. Documents marked as confidential shall be forwarded to third parties only with the express written consent of Hofmann & Vratny.

§ 3 DELIVERY DEADLINES AND DEFAULT OF DELIVERY

1. Delivery deadlines shall be agreed upon by Hofmann & Vratny and the individual Ordering Party or shall be specified by Hofmann & Vratny upon acceptance of the order or in the order confirmation.

2. Hofmann & Vratny’s compliance with delivery obligations shall be conditional upon the Ordering Party’s on-time and proper compliance with the Ordering Party’s obligations including, but not limited to, the provision of the papers, permits and approvals required to be provided by the Ordering Party and the receipt by Hofmann & Vratny of the agreed-upon down payment, if any. In the event of delays, the delivery time shall be extended reasonably.

3. If Hofmann & Vratny is unable to meet any binding delivery deadlines for reasons beyond the control of Hofmann & Vratny (non-availability of services), the Ordering Party shall be notified without undue delay and shall be provided with an estimated new delivery deadline. If the agreed upon Goods do not become available before the new deadline expires, Hofmann & Vratny shall be entitled to rescind the contract in whole or in part and shall reimburse the Ordering Party without undue delay for any and all consideration paid up to that time. For the fulfillment of this clause, non-availability of services shall include, but shall not be limited to, delayed delivery from any of Hofmann & Vratny’s suppliers for reasons beyond the control of Hofmann & Vratny or its suppliers, or if Hofmann & Vratny is not responsible for procuring the Goods.

4. If failure to comply with a delivery deadline is due to an act of God, industrial dispute or other event beyond the control of Hofmann & Vratny, the delivery time shall be extended reasonably. The same shall apply if and when any such act of God, industrial dispute or other event has arisen at any of Hofmann & Vratny’s sub-suppliers which event can be demonstrated to have had an impact on compliance with the delivery deadline. Hofmann & Vratny shall notify the Ordering Party of such circumstances without undue delay. Events also shall be deemed to be beyond Hofmann & Vratny’s control if and when they occur during a delay. In this case, the delay shall be deemed to be suspended for the duration of the respective event.

5. The beginning of a period of delivery default shall be in accordance with the law, but shall in any case require a reminder issued by the Ordering Party.

6. If a contract regarding stand-by delivery has been signed, Hofmann & Vratny shall deliver and invoice the Goods no later than 12 months after the date of such contract (hereinafter referred to as the “Recall Period”), even if the Ordering Party has failed to recall the Goods by that time. After the Recall Period has expired, Hofmann & Vratny can notify the Ordering Party of Hofmann & Vratny’s readiness to deliver and can request that the Ordering Party recall the Goods within a reasonable period of time. If the Ordering Party fails to recall the Goods within such period, Hofmann & Vratny shall be entitled to demand an additional lumpsum compensation for warehousing costs (hereinafter referred to as the “Warehousing Allowance”). The Warehousing Allowance shall be 0.5% of the net value of the purchased Goods for every full week, but shall not exceed 5% of the net value of the purchased Goods in total. The Ordering Party shall be free to prove that Hofmann & Vratny did not incur any damages or that any damages incurred were lower than the Warehousing Allowance. If the Ordering Party fails to recall the Goods within the Recall Period determined by Hofmann & Vratny, Hofmann & Vratny shall be entitled to dispose of the Goods as Hofmann & Vratny sees fit. The statutory provisions regarding rescission shall remain unaffected.

§ 4 DELIVERY AND DEFAULT OF ACCEPTANCE

1. Unless agreed upon otherwise, all deliveries shall be ex works, that is, the place of performance for deliveries and for all subsequent actions. Unless agreed upon otherwise, upon request and at the expense of the Ordering Party the Goods shall be delivered to another destination (hereinafter referred to as “Sales Involving the Carriage of Goods”). Unless agreed upon otherwise, Hofmann & Vratny shall be entitled to determine the shipment method (including, but not limited to, the forwarder, the type of shipment and the packaging).

2. Partial deliveries shall be admissible, provided the Ordering Party reasonably can be expected to accept them.

3. Delivered Goods shall be accepted by the Ordering Party even if the delivered Goods have minor defects provided the Ordering Party reasonably can be expected to accept such Goods.

4. The risk of accidental destruction and/or deterioration of the Goods shall transfer to the Ordering Party no later than upon surrender of the Goods. In the case of Sales Involving the Carriage of Goods, the risk of accidental destruction and/or deterioration of the Goods and the risk of delay shall transfer to the Ordering Party no later than at the time of delivery of the Goods to the forwarder, carrier, or any other person designated to execute shipment of the Goods. Delivery shall be deemed to have been effected even if the Ordering Party is in default of acceptance.

5. If the Ordering Party is in default of acceptance or fails to cooperate or if delivery is delayed for other reasons for which the Ordering Party is responsible, Hofmann & Vratny shall be entitled to demand reimbursement for the damages incurred in connection therewith including additional expenses (e.g., warehousing costs).

§ 5 TERMS OF PAYMENT

1. Unless agreed upon otherwise in individual cases, Hofmann & Vratny’s prices plus statutory sales tax valid at the time the contract is signed shall apply. The prices indicated in Hofmann & Vratny’s catalogs are non-binding and subject to change and/ or correction.

2. Unless agreed upon otherwise, in the case of Sales Involving the Carriage of Goods the Ordering Party shall bear the costs of packaging and transportation ex works and the costs, if any, for transportation insurance if such insurance is requested by the Ordering Party. All customs and other fees, taxes and other public charges also shall be borne by the Ordering Party unless agreed upon otherwise. Ownership of the packaging for transportation and otherwise pursuant to the Verpackungsordnung (Packaging Ordinance of Germany) shall transfer to the Ordering Party and such packaging shall not be returned to Hofmann & Vratny. Pallets shall be exempt from this rule.

3. Unless agreed upon otherwise in the order confirmation, the purchase price plus statutory sales tax shall be due and payable without any deductions within 14 days after the date of invoicing and delivery or acceptance of the Goods. However, Hofmann & Vratny reserves the right to make full or partial deliveries against cash in advance at any time including during an ongoing business relationship. The assertion of such right shall be communicated no later than at the time the order confirmation is issued. The Ordering Party shall be deemed to be in default of payment upon the expiration of the aforementioned payment deadline. The applicable rate of interest on the purchase price of the Goods shall become payable during the default period. The right to assert claims for more substantial compensation shall be reserved. Hofmann & Vratny’s right to claim commercial-rate default interest (§ 353 of the HGB) shall remain unaffected.

4. The Ordering Party’s rights of set-off and retention shall be limited to the extent the Ordering Party’s claim is determined in a court of law or is undisputed. The Ordering Party’s rights based on defects in the purchased Goods (see § 7 hereof) shall remain unaffected.

5. After the contract has been signed, if there is evidence that Hofmann & Vratny’s claim to the purchase price will be compromised due to lack of performance on the part of the Ordering Party, Hofmann & Vratny shall be entitled to refuse performance pursuant to the applicable laws and, after setting a deadline, if applicable, shall be entitled to rescind the contract. In the case of contracts regarding the production of customized items, Hofmann & Vratny shall be entitled to rescind the contract immediately and the laws regarding the expendability of setting deadlines shall remain unaffected.

§ 6 RETENTION OF TITLE

1. Until all pending and future receivables in connection with the business relationship between Hofmann & Vratny and the Ordering Party are paid in full, Hofmann & Vratny shall retain ownership of the Goods. If the Ordering Party violates the contract including, but not limited to, default of payment, Hofmann & Vratny shall be entitled to rescind the contract pursuant to the applicable laws and to demand the surrender of the Goods.

2. Goods subject to retention of title shall not be pledged or assigned as collateral before the Ordering Party has paid in full. The Ordering Party shall notify Hofmann & Vratny in writing without undue delay in the event of a fling for commencement of insolvency proceedings or if third parties gain access (e.g., seizures) to Goods belonging to Hofmann & Vratny.

3. If the Ordering Party violates the contract including, but not limited to, by failing to pay the purchase price when due, Hofmann & Vratny shall be entitled to rescind the contract pursuant to the applicable laws and to demand the surrender of the Goods due to the retention of title and the rescission.

4. Until further notice, the Ordering Party shall be entitled to resell/and or process in the ordinary course of business any Goods subject to retention of title. In this case, the provisions below also shall apply.

a) The retention of title shall include title to the full value of work products resulting from processing, mixing or combining the Goods, in which case Hofmann & Vratny shall be deemed to be the manufacturer. If and when third-party goods are processed, mixed or combined and such third parties retain ownership, Hofmann & Vratny shall acquire coownership pro rata of the invoiced value of work products so processed, mixed or combined. In all other cases, the creation of work products shall be subject to the same provisions as the delivered Goods subject to retention of title.

b) The Ordering Party hereby agrees to assign to Hofmann & Vratny as collateral any and all receivables against third parties resulting from the resale of the Goods or work results in full or in the amount of Hofmann & Vratny’s estimated share of co-ownership pursuant to a) above, and Hofmann & Vratny hereby accepts such assignment. The Ordering Party’s obligations under § 6 2) hereof also shall apply with respect to the receivables assigned.

c) In addition to Hofmann & Vratny, the Ordering Party shall remain authorized to collect receivables. Hofmann & Vratny undertakes to refrain from collecting receivables as long as the Ordering Party meets its payment obligations vis-à-vis Hofmann & Vratny and does not fail to perform and Hofmann & Vratny does not assert its retention of title by asserting a right under § 6 3) hereof. Otherwise, Hofmann & Vratny shall be entitled to demand that the Ordering Party inform Hofmann & Vratny of such receivables assigned and of the names of the debtors, provide Hofmann & Vratny with all the information required for collecting such receivables and the pertinent documents, and inform the debtors (third parties) of the assignment. In addition, in this case Hofmann & Vratny shall be entitled to revoke the Ordering Party’s authorization to resell and/or process Goods which are subject to retention of title.

5. Upon request of the Ordering Party, Hofmann & Vratny shall release the collateral to which Hofmann & Vratny is entitled insofar as the realizable value of such collateral exceeds the receivables to be collateralized by more than 10 percent. Hofmann & Vratny shall be free in its decision regarding which collateral to release.

§ 7 LIABILITY FOR DEFECTS AND CLAIMS FOR DEFECTS

1. Unless otherwise agreed upon herein, the Ordering Party’s rights based on defects in quality and/or in title (including delivery of the wrong Goods or insufficient amounts, improper assembly/installation, or incomplete instructions) shall be subject to the applicable laws. The special legal stipulations regarding reimbursement of expenses at the time of delivery of newly produced Goods (supplier’s recourse as specified in §§ 478, 445a, 445b and §§ 445c, 327 para. 5, 327u of the BGB) shall remain unaffected in any case, unless equal-value compensation has been agreed upon, for example, as part of a quality assurance agreement.

2. Hofmann & Vratny’s liability for defects shall be based first and foremost on the respective agreement entered into regarding the quality and the postulated use of the Goods (including fittings and instructions). In this context, an agreement regarding the quality of Goods shall be any and all product descriptions and manufacturer-provided information outlined in the individual agreement or made publicly known by Hofmann & Vratny (including, but not limited to, in catalogs or on Hofmann & Vratny’s internet homepage) at the time the contract was signed. However, if and when no agreement regarding quality has been entered into, the presence or absence of a defect shall be determined based on the legal regulations (§ 434 para. 3 of the BGB). Statements made publicly by the manufacturer or on the manufacturer’s behalf including, but not limited to, in advertising materials or on labels on the Goods shall prevail over other third parties’ statements. In the case of Goods comprising digital elements or other digital content, Hofmann & Vratny shall be responsible for providing and, if required, updating the digital content only if defined expressly in an agreement regarding the quality of Goods, as stipulated above. Hofmann & Vratny shall not assume any liability for public statements made by the manufacturer or other third parties.

3. Hofmann & Vratny shall not assume liability for any defects of which the Ordering Party is aware, or for any defects of which the Ordering Party is grossly negligent if it is not aware (§ 442 of the BGB) at time the contract is signed. The assertion of claims by the Ordering Party regarding defects shall be conditional upon the Ordering Party’s meeting of its statutory duty to inspect and to give notice of defects (§§

377 and 381 of the HGB (Commercial Code of Germany)). If a defect in the Goods becomes apparent during or after inspection, the Ordering Party shall give written notice to Hofmann & Vratny without undue delay. Regardless of the Ordering Party's duty to inspect and to give notice of defects, the Ordering Party shall give written notice of obvious defects within two weeks after delivery, which notice shall be deemed to have been given in a timely manner if it is transmitted before the end of such period. If the Ordering Party fails to inspect the Goods properly and/or to give proper notice of any defects, Hofmann & Vratny shall not assume liability for any defects for which no notice was given.

4. If any of the Goods are defective, Hofmann & Vratny shall be free to offer supplementary action to remedy the defect or defects (supplementary remedy) or to deliver defect-free Goods (replacement) to the Ordering Party. In individual cases, the Ordering Party may refuse a supplementary action selected by Hofmann & Vratny that the Ordering Party considers to be unreasonable. It is Hofmann & Vratny's right to refuse to offer supplementary action under the applicable laws shall remain unaffected. The requirement for Hofmann & Vratny to provide any supplementary action owed shall be conditional upon the Ordering Party's paying of the purchase price when due. However, the Ordering Party shall be entitled to retain a reasonable portion of the purchase price pro rata in consideration of the defect. The Ordering Party shall give Hofmann & Vratny the time and the opportunity to provide the supplementary action owed including, but not limited to, providing Hofmann & Vratny the opportunity to inspect the Goods which are subject to complaint. If Hofmann & Vratny opts to replace the Goods, at Hofmann & Vratny's request the Ordering Party shall return the defective Goods to Hofmann & Vratny in accordance with the applicable laws; however, the Ordering Party shall not have the right to request to return the defective Goods. Supplementary action shall not include the disassembly, removal, or de-installation of defective Goods nor the assembly, mounting, or installation of defect-free Goods, provided Hofmann & Vratny was not originally obligated to provide such services; any rights the Ordering Party may have to be reimbursed for such costs (hereinafter referred to as "Disassembly and Assembly Costs") shall remain unaffected.

5. If in fact a defect is present, any and all expenses incurred in connection with inspections and supplementary action including, but not limited to, transportation, road, labor and material costs, and Disassembly and Assembly Costs shall be borne by Hofmann & Vratny in accordance with the laws and these General Terms of Sale. However, if the Ordering Party's demand for remedy of a defect is proven to be invalid because the Ordering Party was aware or was grossly negligent if it was not aware that no defect actually was present, Hofmann & Vratny can demand reimbursement from the Ordering Party for any costs incurred therewith. If the costs of supplementary remedy would be disproportionately high, the Ordering Party shall not be entitled to claim remedy of defects.

6. If and when a reasonable deadline for supplementary action set by the buyer has expired unsuccessfully or can be disregarded under the law, the Ordering Party can rescind the purchasing contract in accordance with the law or reduce the purchase price. However, no right to rescind shall apply in the case of insignificant defects.

7. The Ordering Party's claims for damages or reimbursement for wasted expenses shall be limited by the provisions of § 8 below and shall be excluded in all other cases.

8. The statute of limitations for claims for defects in quality and in title shall be one year after delivery of the Goods. The statute of limitations shall commence upon delivery of the Goods provided acceptance has been agreed upon. Other special legal stipulations regarding statutes of limitations (including, but not limited to, § 438 para. 1 no. 1, no. 2, para. 3, §§ 444, 445b of the BGB) shall remain unaffected. The aforementioned statutes of limitations specified in the purchasing laws also shall apply to any contractual and extra-contractual claims for reimbursement made by the Ordering Party based on a defect in the Goods, unless applying the regular statute of limitations stipulated by law (§§ 195, 199 of the BGB) would result in a reduced statute of limitations in individual cases. Any claims for reimbursement

the Ordering Party may have pursuant to § 8 para. 2 p. 1 and p. 2 (a) and pursuant to the Produkthaftungsgesetz (Product Liability Act of Germany) shall be subject exclusively to the statutes of limitations stipulated by law.

§ 8 OTHER LIABILITIES

1. Unless agreed upon otherwise in these General Terms of Sale and in the provisions below, Hofmann & Vratny's liability for breach of contractual and non-contractual obligations shall be in accordance with the applicable laws.

2. Hofmann & Vratny's liability for damages, regardless of the legal reasons and of whether or not they are known, as part of Verschuldenshaftung (liability arising from damage caused by negligent act) shall include intent and gross negligence. Subject to the limitations of liability stipulated by law (e.g., diligence with its own affairs, insignificant breach of duty), in the event of minor negligence Hofmann & Vratny's liability shall be limited to (a) damages resulting from harm to life, body or health and/or (b) damages resulting from the not-insignificant breach of a material contractual obligation, that is, an obligation which must be met to make the proper fulfillment of the contract possible and the meeting of which the Ordering Party relies upon and can rely upon on a regular basis. In this case, however, Hofmann & Vratny's liability shall be limited to reimbursement of the foreseeable damages typical in such cases.

3. The limitation of liability specified above also shall apply vis-à-vis third parties and in the event of a breach of duty by any person (including to his/her own benefit) for which Hofmann & Vratny is responsible by law; however, it shall not apply if and when Hofmann & Vratny is found to have failed to disclose a defect maliciously or has assumed a guarantee for the quality of the Goods and for the Ordering Party's claims under the Produkthaftungsgesetz.

4. The Ordering Party can rescind or cancel a contract due to a breach of obligation other than a breach based on a defect only if and when Hofmann & Vratny is responsible for such breach of obligation. The Ordering Party shall not have an unrestricted right to terminate a contract. All other cases shall be subject to the applicable laws and legal consequences.

§ 9 APPLICABLE LAW AND JURISDICTION

1. These General Terms of Sale and all legal relationships between Hofmann & Vratny and the Ordering Party shall be subject to the laws of the Federal Republic of Germany under exclusion of the provisions of uniform international law. The CISG shall not apply.

2. Any and all disputes arising directly or indirectly from the contractual relationship shall be subject exclusively, including at an international level, to the jurisdiction of Aßling if the Ordering Party is a businessperson as defined in the Handelsgesetzbuch (Commercial Code of Germany), a legal entity under public law, or a special fund under public law. The same shall apply if the Ordering Party is an entrepreneur pursuant to §§ 14 of the BGB. However, in any case Hofmann & Vratny shall be entitled to sue the Ordering Party at the place of performance of the obligation to deliver under these General Terms of Sale and/or under a prevailing individual agreement or at the Ordering Party's general jurisdiction. Prevailing legal regulations including, but not limited to, regarding exclusive jurisdictions, shall remain unaffected.

Hofmann & Vratny OHG
June 2022

Hofmann & Vratny OHG - Regrinding centre

Poststr. 15a Telephone: +49 80 92 / 85 333-152
90471 Nürnberg E-Mail: nbg@vhmhv.de

**CONTACT
HOFMANN & VRATNY**

Hofmann & Vratny OHG - Headquarters

Steinkirchen 4½ Telephone: +49 80 92 / 85 333-0
85617 Aßling E-Mail: info@vhmhv.de

A RELIABLE PARTNER

**DISCOVER OUR
H&V PRODUCT RANGE.**

Our goal is to provide companies around the world with the best tools.

We are constantly developing our product portfolio. We experiment with new geometries, coatings and materials at our research and development center to make the right tool for every application.

SCAN THE
QR CODE NOW



EXPERT | Non-ferrous materials



EXPERT | Steel & cast iron



EXPERT | Stainless steel



EXPERT | Hardened steel



BASIC | Universal





EN

HOFMANN & VRATNY TITANIUM BROCHURE

Hofmann & Vratny OHG
Steinkirchen 4½
85617 Aßling

Telephone: +49 80 92 / 85 333-0
E-Mail: info@vhmhv.de
Web: www.vhmv.de



OFFICIAL PARTNER OF H&V

