

HOFMANN & VRATNY — SC MILLING CUTTERS EN

HARDENED STEEL

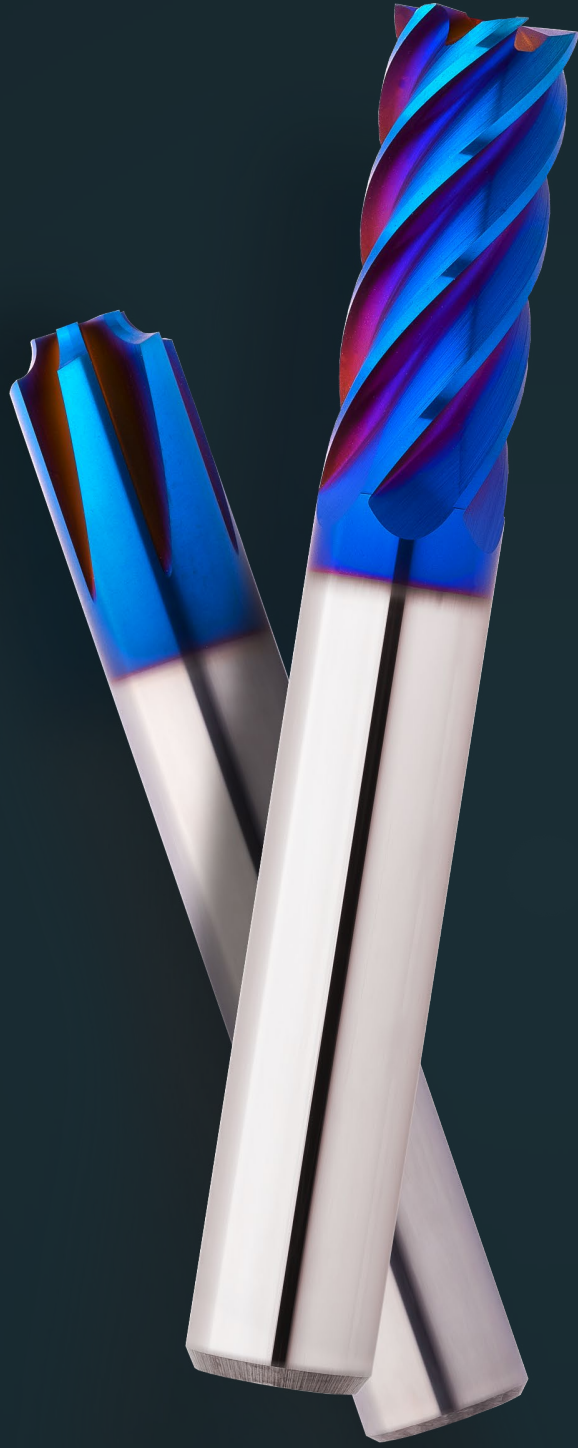

Expert

2025



THE RIGHT TOOL. AT ALL TIMES.

Welcome to Hofmann & Vratny. As leading manufacturer of solid carbide tools, we enable companies throughout the world to manufacture their products.

Every day, our strong team works on our collective goal of producing the best tools in the world. Companies from the medical industry, semi-conductor industry, machine and plant construction, aviation, aerospace engineering and, not least, the automotive industry have been using our milling cutters for decades now. Quality – Made in Bavaria.

The success of our company is built on innovation, a culture of cooperation, open interaction with high respect and many years of successful and trustful collaboration with our business partners. You can always count on us, our tools and our irreplaceable drive to shape the future of the industry together. To us, that means shaping tomorrow.

Andreas Vratny

Zdenek Vratny

Marius Heinemann-Grüder



**HARDENED
STEEL**

49
YEARS OF
EXPERIENCE

2 Mio.
TOOLS
PRODUCED
EVERY YEAR

MILLING CUTTERS



**MADE IN
BAVARIA**

PROVEN QUALITY

DRILLS



**MADE IN
CZECHIA**

PROVEN QUALITY

- Manufacturer of solid carbide cutting tools for a wide range of materials
- Founded 1976
- 2 locations in Bavaria and 1 location in Czechia
- Headquarters with milling cutter production in Aßling near Munich
- Regrinding center in Nuremberg
- Location with drill production in Ivančice near Brno



BEHIND THE SCENES

PRODUCTION ENVIRONMENT: ALWAYS UP TO DATE



On a production area of 3,751m², we produce around 2 million tools per year. In order to guarantee the precise manufacture of our tools, our clean production halls are kept at a constant temperature of 24 °C.

PLANT FOR MACRO TOOLS

- Manufacturing of diameter 8 - 32 mm
- Use of 5 & 6-axis CNC grinding machines with 12-position grinding wheel changer enable us to manufacture complex tool geometries
- Radius tolerance of less than 5 µm
- Laser micrometer with measuring ranges up to 50 mm covers a wide product range

PLANT FOR MICRO TOOLS

- Manufacturing from diameter 0.1 - 6 mm
- Use of 5 & 6-axis CNC grinding machines especially with linear and hydrostatic technology
- Tolerances are 3 µm for concentricity and radii and 5 µm for diameter
- CNC measuring machines for recording and measuring the smallest geometries up to 0.1 mm diameter

PLANT FOR SC DRILLS

- Production of standard and special drills
- Use of 5 & 6-axis grinding machines with steady rest
- Measuring technology for particularly long tools

DEPARTMENT FOR SPECIAL TOOLS

- Production of a wide range of semi-standard and special tools
- The delivery times for the special milling cutters are as follows:
 - 3 weeks uncoated
 - 4 weeks coated
 - 6 weeks diamond-coated

REGRINDING CENTRE

- Original reconditioning of Hofmann & Vratny tools
- Regrinding of third-party tools
- The delivery times for reground tools are as follows:
 - without colour coating: 21 calendar days
 - with colour coating: 28 calendar days

RESEARCH & DEVELOPMENT: THE ORIGIN OF OUR INNOVATIONS



In our R&D department, we develop various milling cutter geometries and work together with our partners on innovative coatings and high-performance substrates. Furthermore, on a total of four CNC milling machines, our milling cutters and those of our competitors are tested here every day in order to develop our tools in the best possible way for state-of-the-art production processes.

WAREHOUSE & LOGISTICS: SHIPPING TOGETHER

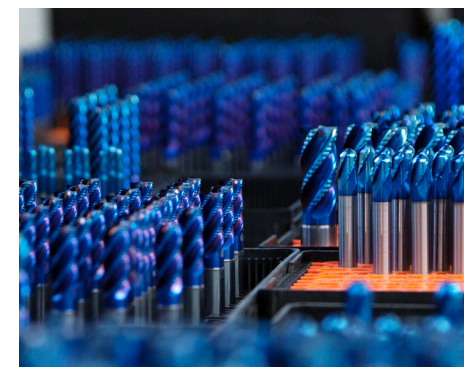

Through our global partner and trading network, we supply the manufacturing industries worldwide and work hand in hand to develop tools that meet customer requirements and market demands. In our warehouse and logistics department, our tools go through a multi-stage process every day to ensure that they reach the customer in perfect condition. With a stock availability of over 98.5 %, we guarantee same-day dispatch for orders received by 3 pm.

PEOPLE ARE THE CENTRE OF ALL OUR ACTIVITIES



Every day, our team makes a significant contribution to the success of our company, which is why it is all the more important to us that our employees feel comfortable and enjoy their work alongside their day-to-day tasks. To contribute to the well-being of our employees, we offer:

- a daily free hot lunch in our canteen
- free hot and cold drinks
- many social benefits

WOULD YOU LIKE TO GET YOUR OWN IMPRESSION OF US?

Then come and visit us with our partner.

GET EVEN MORE INSIGHTS
BEHIND THE SCENES:



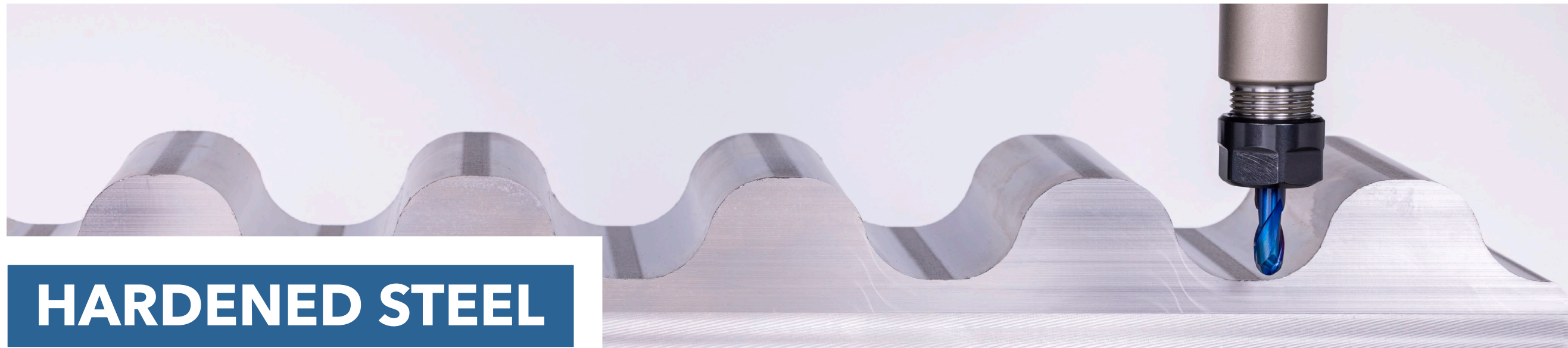

HARDENED STEEL

3
PRODUCTION
SITES

48
YEARS OF
EXPERIENCE

140
MOTIVATED
EMPLOYEES

THE FAMOUS BLUE ORIGINAL.

The H&V Expert hard machining milling cutters have been specially designed and developed to meet the requirements of hardened steel. Selected ultrafine carbide grade, proven geometries, coordinated edge preparation and the blue coating, which has been known for years, form the perfect synergy for safe machining of hardened steels up to 70 HRC.

QUALITY
PROCESS RELIABILITY
ECONOMIC EFFICIENCY

K201523 | PERFORMMAKER Z4-10 2XD ADN

HELICAL PITCH

Extremely soft cut at up to 70 HRC.

GEOMETRY

Refined geometry for reliable chip removal and consistently high process reliability.

MATERIAL

Solid carbide specially developed for hardened steels.

FACE

Radius and face geometries optimized to prevent premature breakouts.

BLADES

Cutting edge preparation that has been tried and tested for decades and optimised to perfection.

COATING

The original blue coating for hard machining, often imitated but never achieved.



TABLE OF CONTENTS

PERFORMMAKER | END MILL CUTTER

K201523 | Performmaker Z4-10 short ADN _____ 12



K201533 | Performmaker Z6-10 long ADN _____ 14



FORMMAKER | TORUS CUTTER

K202223 | Formmaker Z4 1xD ADN _____ 16



K202233 | Formmaker Z4 1xD long ADN _____ 20



K202253 | Formmaker Z4-6 1xD ADN _____ 24



K202293 | Formmaker Z6-10 short ADN _____ 28



K202303 | Formmaker Z6-10 long ADN _____ 30



K202307 | Formmaker Z8-10 overlong ADN _____ 32



BLADEMAKER | FACE TORUS CUTTER

K207013 | Blademaker Z2-5 0.5xD short ADN _____ 34



K207018 | Blademaker Z2-5 0,5xD long ADN _____ 36



ROWMAKER | FULL RADIUS CUTTER

K203103 | Rowmaker Z2 1xD short ADN _____ 38



K203143 | Rowmaker Z2 1.5xD long ADN _____ 42



K203153 | Rowmaker Z2 1xD long ADN _____ 46



K203333 | Rowmaker Z4 1xD short ADN _____ 48



K203343 | Rowmaker Z4 1xD long ADN _____ 50



CHAMFMAKER | DEBURRING CUTTER

K205153 | Chamfmaker Z3-4 60° ADN _____ 52



K205154 | Chamfmaker Z4 60° ADN _____ 54



K205163 | Chamfmaker Z3-4 90° ADN _____ 56



K205164 | Chamfmaker Z4 90° ADN _____ 58



ROUNDMAKER | CORNER ROUNDING CUTTER

K204108 | Roundmaker Z6 ADN _____ 60



PERFORMMAKER MICRO | MICRO END MILL CUTTER

K201122 | Performmaker Micro Z2 ADN _____ 62



FORMMAKER MICRO | MICRO TORUS CUTTER

K202082 | Formmaker Micro Z2 R0.1 ADN _____ 74



K202092 | Formmaker Micro Z2 R0.2 ADN _____ 80



K202102 | Formmaker Micro Z2 R0.3 ADN _____ 86



K202112 | Formmaker Micro Z2 R0.5 ADN _____ 92



ROWMAKER MICRO | MICRO FULL RADIUS CUTTER

K203206 | Rowmaker Micro Z2 ADN _____ 96



K203212 | Rowmaker Micro Z2 long ADN _____ 104



EXPLANATION _____ 108

MATERIAL OVERVIEW _____ 110

TECHNICAL FORMULAS _____ 111

GENERAL TERMS OF SALE _____ 112

DISCOVER OUR H&V PRODUCT RANGE _____ 117

Cooling	
Tolerance	e8
Coating	AlphaDura Navy

Strategy	ETC	HPC	
Application			
Features	HA		

- Ultrafine carbide grade specially developed for machining hardened steels
 - Adapted rake angle for safe milling up to 70 HRC
 - Defined cutting edge preparation for homogeneous wear
-
- For roughing and finishing
-
- Reduce the axial depth of cutting with increasing hardness

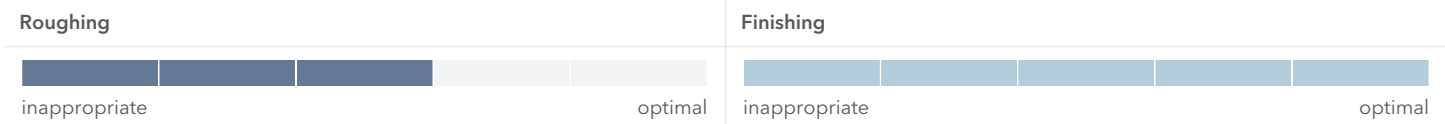
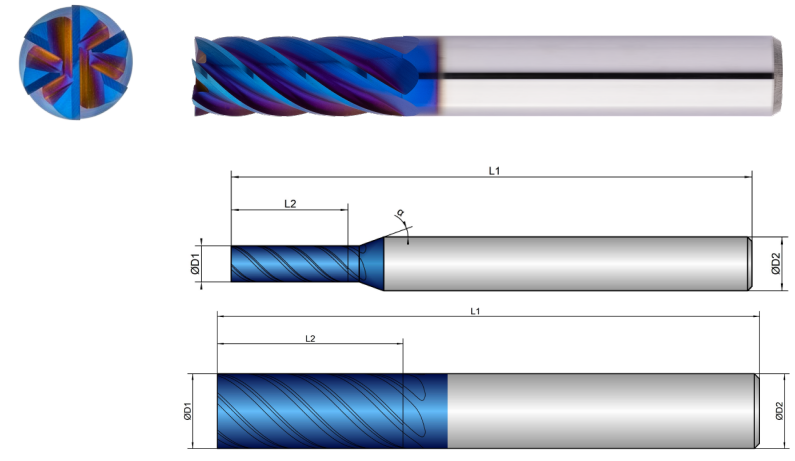

K201523	D1 mm ø	L2 mm	L1 mm	D2 mm ø	z #	 °	α °
2X8	2.0	8.0	58.0	6.0	4	37.5	12
3X12	3.0	12.0	58.0	6.0	4	37.5	12
4X13	4.0	13.0	58.0	6.0	4	37.5	12
5X15	5.0	15.0	58.0	6.0	6	37.5	12
6X16	6.0	16.0	58.0	6.0	6	37.5	12
8X22	8.0	22.0	70.0	8.0	6	37.5	12
10X25	10.0	25.0	73.0	10.0	6	37.5	12
12X28	12.0	28.0	84.0	12.0	6	37.5	12
14X30	14.0	30.0	84.0	14.0	6	37.5	12
16X36	16.0	36.0	93.0	16.0	8	37.5	12
18X36	18.0	36.0	93.0	18.0	10	37.5	12
20X41	20.0	41.0	104.0	20.0	10	37.5	12

Dimension	Ø2	Ø3	Ø4	Ø5	Ø6	Ø8	Ø10	Ø12	Ø14	Ø16
Infeed in mm	ae= 0.05xD ap= L2 max	ae= 0.05xD ap= L2 max	ae= 0.05xD ap= L2 max	ae= 0.05xD ap= L2 max	ae= 0.05xD ap= L2 max	ae= 0.05xD ap= L2 max	ae= 0.05xD ap= L2 max	ae= 0.05xD ap= L2 max	ae= 0.05xD ap= L2 max	ae= 0.05xD ap= L2 max
Application										

Material	Hardness in HRC	Feed (mm/Z)	fz	fz	fz	fz	fz	fz	fz	fz	fz	fz
H	HARDENED STEEL	Vc (m/min)										
1.1	46-55	130	0.02	0.025	0.03	0.035	0.04	0.045	0.05	0.055	0.055	0.07
1.2	56-60	100	0.018	0.022	0.028	0.032	0.038	0.042	0.047	0.052	0.052	0.065
1.3	60-65	85	0.015	0.02	0.025	0.03	0.035	0.04	0.045	0.05	0.05	0.06
1.4	66-70	70	0.012	0.015	0.02	0.025	0.03	0.03	0.035	0.04	0.04	0.05

Dimension	Ø18	Ø20
Infeed in mm	ae= 0.05xD ap= L2 max	ae= 0.05xD ap= L2 max
Application		

Material	Hardness in HRC	Feed (mm/Z)	fz	fz
H	HARDENED STEEL	Vc (m/min)		
1.1	46-55	130	0.07	0.08
1.2	56-60	100	0.065	0.075
1.3	60-65	85	0.06	0.07
1.4	66-70	70	0.05	0.06



Cooling	
Tolerance	e8
Coating	AlphaDura Navy

Strategy	ETC	HPC	
Application			
Features	HA		

- Ultrafine carbide grade specially developed for machining hardened steels
 - Adapted rake angle for safe milling up to 70 HRC
 - Defined cutting edge preparation for homogeneous wear
-
- For roughing and finishing
-
- Reduce the axial depth of cutting with increasing hardness

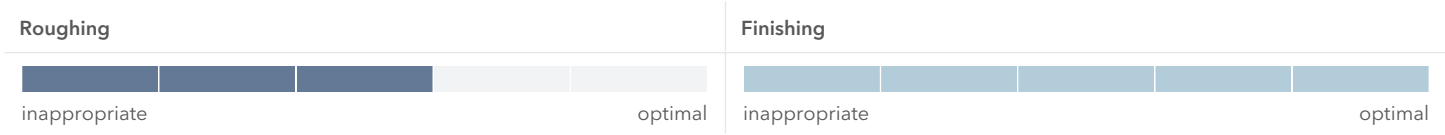
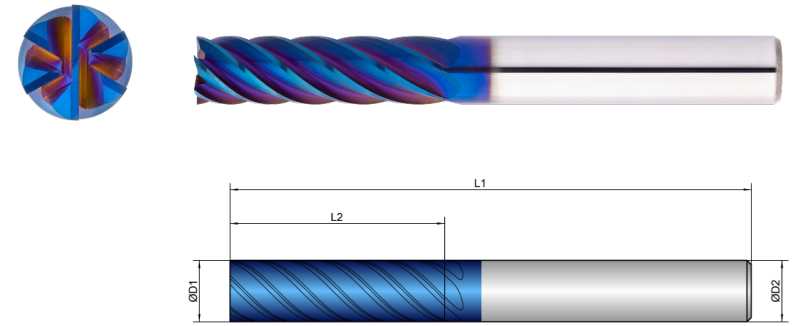

	D1 mm Ø	L2 mm	L1 mm	D2 mm Ø	z #	 °
K201533						
6X21	6.0	21.0	65.0	6.0	6	37.5
8X28	8.0	28.0	75.0	8.0	6	37.5
10X35	10.0	35.0	85.0	10.0	6	37.5
12X45	12.0	45.0	100.0	12.0	6	37.5
14X45	14.0	45.0	100.0	14.0	6	37.5
16X50	16.0	50.0	110.0	16.0	8	37.5
16X65	16.0	65.0	125.0	16.0	8	37.5
18X54	18.0	54.0	114.0	18.0	10	37.5
20X55	20.0	55.0	126.0	20.0	10	37.5
20X70	20.0	70.0	135.0	20.0	10	37.5
20X75	20.0	75.0	135.0	20.0	10	37.5
25X75	25.0	75.0	150.0	25.0	10	37.5

Dimension	Ø6	Ø8	Ø10	Ø12	Ø14	Ø16	Ø18	Ø20	Ø25
Infeed in mm	ae= 0.05xD ap= L2 max	ae= 0.05xD ap= L2 max	ae= 0.05xD ap= L2 max	ae= 0.05xD ap= L2 max	ae= 0.05xD ap= L2 max	ae= 0.05xD ap= L2 max	ae= 0.05xD ap= L2 max	ae= 0.05xD ap= L2 max	ae= 0.05xD ap= L2 max
Application									

H	Material	Hardness in HRC	Feed (mm/Z)	Vc (m/min)									
				fz	fz	fz	fz	fz	fz	fz	fz	fz	fz
1.1	HARDENED STEEL	46-55	120	0.04	0.045	0.05	0.055	0.055	0.07	0.07	0.08	0.085	
1.2		56-60	90	0.038	0.042	0.047	0.052	0.052	0.065	0.065	0.075	0.08	
1.3		60-65	75	0.035	0.04	0.045	0.05	0.05	0.06	0.06	0.07	0.075	
1.4		66-70	60	0.03	0.03	0.035	0.04	0.04	0.05	0.05	0.06	0.065	



Cooling	
Tolerance	e8
Coating	AlphaDura Navy

Strategy	HSC	HPC	
Application			
Features	HA	≠	

- Ultrafine carbide grade specially developed for machining hardened steels
 - Adapted rake angle for safe milling up to 70 HRC
 - Defined cutting edge preparation for homogeneous wear
-
- Multipass milling of 3D contours
-
- Radius tolerance $r \leq 1.5$ mm: ± 0.003 mm
 - Radius tolerance $r > 1.5$ mm: ± 0.005 mm

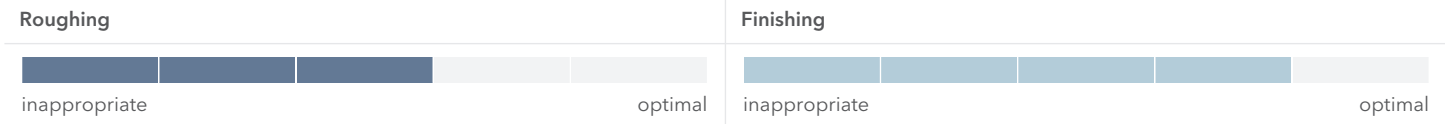
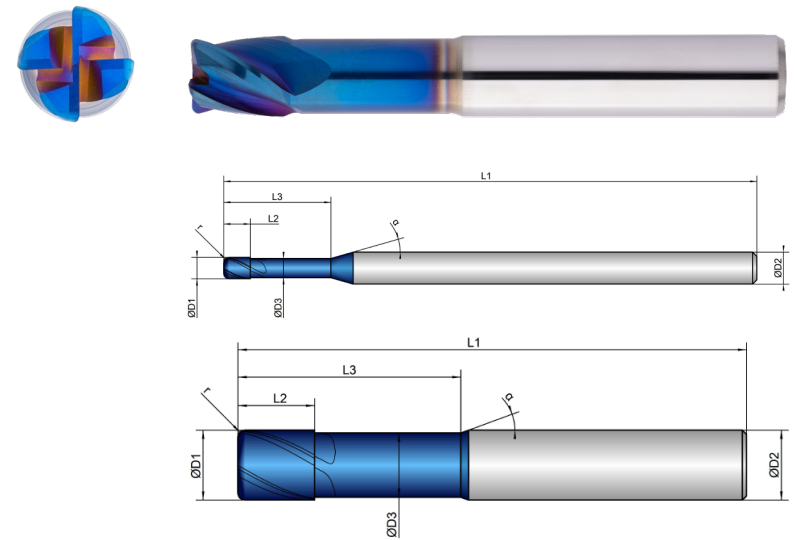

K202223	D1 mm ∅	D3 mm ∅	L2 mm	L3 mm	L1 mm	D2 mm ∅	z #	r mm		α °
1/0,1	1.0	0.85	1.5	10.0	50.0	3.0	4	0.10	35	20
1/0,2	1.0	0.85	1.5	10.0	50.0	3.0	4	0.20	35	20
2/0,2	2.0	1.8	2.5	12.0	50.0	3.0	4	0.20	35	20
2/0,3	2.0	1.8	2.5	12.0	50.0	3.0	4	0.30	35	20
2/0,5	2.0	1.8	2.5	12.0	50.0	3.0	4	0.50	35	20
3/0,25	3.0	2.7	4.0	14.0	50.0	3.0	4	0.25	35	20
3/0,3	3.0	2.7	4.0	14.0	50.0	3.0	4	0.30	35	20
3/0,5	3.0	2.7	4.0	14.0	50.0	3.0	4	0.50	35	20
3/1	3.0	2.7	4.0	14.0	50.0	3.0	4	1.00	35	20
4/0,2	4.0	3.7	5.0	16.0	50.0	4.0	4	0.20	35	20
4/0,25	4.0	3.7	5.0	16.0	50.0	4.0	4	0.25	35	20
4/0,4	4.0	3.7	5.0	16.0	50.0	4.0	4	0.40	35	20
4/0,5	4.0	3.7	5.0	16.0	50.0	4.0	4	0.50	35	20
4/1	4.0	3.7	5.0	16.0	50.0	4.0	4	1.00	35	20
5/0,25	5.0	4.6	6.0	18.0	54.0	5.0	4	0.25	35	20
5/0,5	5.0	4.6	6.0	18.0	54.0	5.0	4	0.50	35	20

K202223	D1 mm ∅	D3 mm ∅	L2 mm	L3 mm	L1 mm	D2 mm ∅	z #	r mm		α °
5/1	5.0	4.6	6.0	18.0	54.0	5.0	4	1.00	35	20
6/0,25	6.0	5.5	7.0	21.0	58.0	6.0	4	0.25	35	20
6/0,5	6.0	5.5	7.0	21.0	58.0	6.0	4	0.50	35	20
6/0,8	6.0	5.5	7.0	21.0	58.0	6.0	4	0.80	35	20
6/1	6.0	5.5	7.0	21.0	58.0	6.0	4	1.00	35	20
6/1,5	6.0	5.5	7.0	21.0	58.0	6.0	4	1.50	35	20
6/2	6.0	5.5	7.0	21.0	58.0	6.0	4	2.00	35	20
8/0,25	8.0	7.4	9.0	27.0	64.0	8.0	4	0.25	35	20
8/0,5	8.0	7.4	9.0	27.0	64.0	8.0	4	0.50	35	20
8/0,8	8.0	7.4	9.0	27.0	64.0	8.0	4	0.80	35	20
8/1	8.0	7.4	9.0	27.0	64.0	8.0	4	1.00	35	20
8/1,5	8.0	7.4	9.0	27.0	64.0	8.0	4	1.50	35	20
8/2	8.0	7.4	9.0	27.0	64.0	8.0	4	2.00	35	20
8/2,5	8.0	7.4	9.0	27.0	64.0	8.0	4	2.50	35	20
8/3	8.0	7.4	9.0	27.0	64.0	8.0	4	3.00	35	20
10/0,25	10.0	9.2	11.0	32.0	73.0	10.0	4	0.25	35	20
10/0,5	10.0	9.2	11.0	32.0	73.0	10.0	4	0.50	35	20
10/0,8	10.0	9.2	11.0	32.0	73.0	10.0	4	0.80	35	20
10/1	10.0	9.2	11.0	32.0	73.0	10.0	4	1.00	35	20
10/1,5	10.0	9.2	11.0	32.0	73.0	10.0	4	1.50	35	20
10/2	10.0	9.2	11.0	32.0	73.0	10.0	4	2.00	35	20
10/3	10.0	9.2	11.0	32.0	73.0	10.0	4	3.00	35	20
10/3,5	10.0	9.2	11.0	32.0	73.0	10.0	4	3.50	35	20
12/0,5	12.0	9.2	12.0	38.0	84.0	12.0	4	0.50	35	20
12/1	12.0	9.2	12.0	38.0	84.0	12.0	4	1.00	35	20
12/1,5	12.0	9.2	12.0	38.0	84.0	12.0	4	1.50	35	20
12/2	12.0	9.2	12.0	38.0	84.0	12.0	4	2.00	35	20
12/3	12.0	9.2	12.0	38.0	84.0	12.0	4	3.00	35	20
16/1	16.0	15.0	16.0	44.0	93.0	16.0	4	1.00	35	20
16/2	16.0	15.0	16.0	44.0	93.0	16.0	4	2.00	35	20
16/3	16.0	15.0	16.0	44.0	93.0	16.0	4	3.00	35	20
20/1	20.0	18.5	20.0	55.0	104.0	20.0	4	1.00	35	20
20/2,5	20.0	18.5	20.0	55.0	104.0	20.0	4	2.50	35	20

Dimension	Ø1		Ø2		Ø3		Ø4		Ø5		Ø6	
Infeed in mm	ae=0.05xD	ae=0.04xD	ae=0.05xD	ae=0.04xD	ae=0.05xD	ae=0.04xD	ae=0.05xD	ae=0.04xD	ae=0.05xD	ae=0.04xD	ae=0.05xD	ae=0.04xD
Application	ap=L2 max	ap=0.04xD	ap=L2 max	ap=0.04xD	ap=L2 max	ap=0.04xD	ap=L2 max	ap=0.04xD	ap=L2 max	ap=0.04xD	ap=L2 max	ap=0.04xD

Material	Hardness in HRC	Feed (mm/Z)	Vc (m/min)												
H	HARDENED STEEL		fz	fz	fz	fz	fz	fz	fz	fz	fz	fz	fz	fz	fz
1.1	46-55	130	0.015	0.017	0.02	0.025	0.025	0.03	0.03	0.035	0.035	0.04	0.04	0.045	
1.2	56-60	100	0.012	0.014	0.018	0.022	0.022	0.028	0.028	0.032	0.032	0.038	0.038	0.042	
1.3	60-65	85	0.01	0.012	0.015	0.02	0.02	0.025	0.025	0.03	0.03	0.035	0.035	0.04	
1.4	66-70	70	0.007	0.009	0.012	0.017	0.015	0.02	0.02	0.025	0.025	0.03	0.03	0.035	

Dimension	Ø8		Ø10		Ø12		Ø16		Ø20	
Infeed in mm	ae=0.05xD	ae=0.04xD	ae=0.05xD	ae=0.04xD	ae=0.05xD	ae=0.04xD	ae=0.05xD	ae=0.04xD	ae=0.05xD	ae=0.04xD
Application	ap=L2 max	ap=0.04xD	ap=L2 max	ap=0.04xD	ap=L2 max	ap=0.04xD	ap=L2 max	ap=0.04xD	ap=L2 max	ap=0.04xD

Material	Hardness in HRC	Feed (mm/Z)	Vc (m/min)											
H	HARDENED STEEL		fz	fz	fz	fz	fz	fz	fz	fz	fz	fz	fz	fz
1.1	46-55	130	0.045	0.05	0.05	0.055	0.055	0.07	0.07	0.075	0.08	0.085		
1.2	56-60	100	0.042	0.048	0.047	0.053	0.052	0.065	0.065	0.07	0.075	0.08		
1.3	60-65	85	0.04	0.045	0.045	0.05	0.05	0.06	0.06	0.065	0.07	0.075		
1.4	66-70	70	0.03	0.035	0.035	0.045	0.04	0.055	0.05	0.06	0.06	0.07		

ADVICE | By using multipass milling the maximum infeed (ae, ap) is 0.5x corner radius!



STILL CAN'T FIND A SUITABLE MILLING CUTTER?

No problem - simply customize an existing tool. Using our configurator for special milling cutters, you can customize existing tools to your needs in an instant or create your own tools based on predefined types.

WE WILL RESPOND TO ALL REQUESTS SUBMITTED VIA THE CONFIGURATOR WITHIN ONE WORKING DAY AT THE LATEST



Cooling	
Tolerance	e8
Coating	AlphaDura Navy

Strategy	HSC	HPC	
Application			
Features	HA	≠	

- Ultrafine carbide grade specially developed for machining hardened steels
 - Adapted rake angle for safe milling up to 70 HRC
 - Defined cutting edge preparation for homogeneous wear
-
- Long version for deeper cavities
 - Multipass milling of 3D contours
-
- Radius tolerance $r \leq 1.5 \text{ mm}$: $\pm 0.003 \text{ mm}$
 - Radius tolerance $r > 1.5 \text{ mm}$: $\pm 0.005 \text{ mm}$

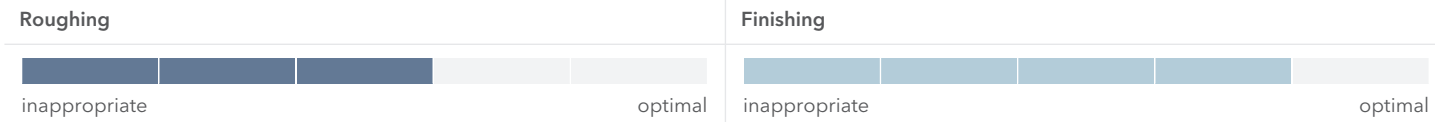
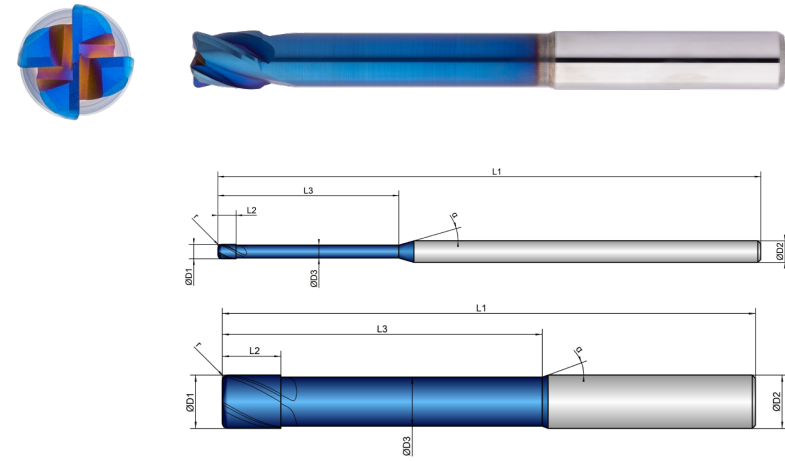

K202233	D1 mm \varnothing	D3 mm \varnothing	L2 mm	L3 mm	L1 mm	D2 mm \varnothing	z #	r mm	α °	
1/0,1	1.0	0.85	1.5	20.0	75.0	3.0	4	0.10	35	20
1/0,2	1.0	0.85	1.5	20.0	75.0	3.0	4	0.20	35	20
2/0,2	2.0	1.8	2.5	25.0	75.0	3.0	4	0.20	35	20
2/0,3	2.0	1.8	2.5	25.0	75.0	3.0	4	0.30	35	20
2/0,5	2.0	1.8	2.5	25.0	75.0	3.0	4	0.50	35	20
3/0,25	3.0	2.7	4.0	32.0	75.0	3.0	4	0.25	35	20
3/0,3	3.0	2.7	4.0	32.0	75.0	3.0	4	0.30	35	20
3/0,5	3.0	2.7	4.0	32.0	75.0	3.0	4	0.50	35	20
3/1	3.0	2.7	4.0	32.0	75.0	3.0	4	1.00	35	20
4/0,2	4.0	3.7	5.0	36.0	75.0	4.0	4	0.20	35	20
4/0,25	4.0	3.7	5.0	36.0	75.0	4.0	4	0.25	35	20
4/0,4	4.0	3.7	5.0	36.0	75.0	4.0	4	0.40	35	20
4/0,5	4.0	3.7	5.0	36.0	75.0	4.0	4	0.50	35	20
4/1	4.0	3.7	5.0	36.0	75.0	4.0	4	1.00	35	20
5/0,25	5.0	4.6	6.0	40.0	75.0	5.0	4	0.25	35	20
5/0,5	5.0	4.6	6.0	40.0	75.0	5.0	4	0.50	35	20

K202233	D1 mm \varnothing	D3 mm \varnothing	L2 mm	L3 mm	L1 mm	D2 mm \varnothing	z #	r mm	α °	
5/1	5.0	4.6	6.0	40.0	75.0	5.0	4	1.00	35	20
6/0,25	6.0	5.5	7.0	44.0	80.0	6.0	4	0.25	35	20
6/0,5	6.0	5.5	7.0	44.0	80.0	6.0	4	0.50	35	20
6/1	6.0	5.5	7.0	44.0	80.0	6.0	4	1.00	35	20
6/1,5	6.0	5.5	7.0	44.0	80.0	6.0	4	1.50	35	20
8/0,25	8.0	7.4	9.0	54.0	100.0	8.0	4	0.25	35	20
8/0,5	8.0	7.4	9.0	54.0	100.0	8.0	4	0.50	35	20
8/0,8	8.0	7.4	9.0	54.0	100.0	8.0	4	0.80	35	20
8/1	8.0	7.4	9.0	54.0	100.0	8.0	4	1.00	35	20
8/1,5	8.0	7.4	9.0	54.0	100.0	8.0	4	1.50	35	20
8/2	8.0	7.4	9.0	54.0	100.0	8.0	4	2.00	35	20
8/3	8.0	7.4	9.0	54.0	100.0	8.0	4	3.00	35	20
10/0,25	10.0	9.2	11.0	60.0	100.0	10.0	4	0.25	35	20
10/0,5	10.0	9.2	11.0	60.0	100.0	10.0	4	0.50	35	20
10/0,8	10.0	9.2	11.0	60.0	100.0	10.0	4	0.80	35	20
10/1	10.0	9.2	11.0	60.0	100.0	10.0	4	1.00	35	20
10/1,5	10.0	9.2	11.0	60.0	100.0	10.0	4	1.50	35	20
10/2	10.0	9.2	11.0	60.0	100.0	10.0	4	2.00	35	20
10/3	10.0	9.2	11.0	60.0	100.0	10.0	4	3.00	35	20
12/0,5	12.0	11.0	12.0	75.0	120.0	12.0	4	0.50	35	20
12/1	12.0	11.0	12.0	75.0	120.0	12.0	4	1.00	35	20
12/1,5	12.0	11.0	12.0	75.0	120.0	12.0	4	1.50	35	20
12/2	12.0	11.0	12.0	75.0	120.0	12.0	4	2.00	35	20
12/3	12.0	11.0	12.0	75.0	120.0	12.0	4	3.00	35	20
16/1	16.0	15.0	16.0	92.0	150.0	16.0	4	1.00	35	20
16/2	16.0	15.0	16.0	92.0	150.0	16.0	4	2.00	35	20
16/3	16.0	15.0	16.0	92.0	150.0	16.0	4	3.00	35	20
20/1	20.0	18.5	20.0	92.0	150.0	20.0	4	1.00	35	20
20/2,5	20.0	18.5	20.0	92.0	150.0	20.0	4	2.50	35	20

Dimension	Ø1		Ø2		Ø3		Ø4		Ø5		Ø6	
Infeed in mm	ae=0.05xD	ae=0.04xD	ae=0.05xD	ae=0.04xD	ae=0.05xD	ae=0.04xD	ae=0.05xD	ae=0.04xD	ae=0.05xD	ae=0.04xD	ae=0.05xD	ae=0.04xD
	ap=L2 max	ap=0.04xD	ap=L2 max	ap=0.04xD	ap=L2 max	ap=0.04xD	ap=L2 max	ap=0.04xD	ap=L2 max	ap=0.04xD	ap=L2 max	ap=0.04xD
Application												

Material	Hardness in HRC	Feed (mm/Z)	fz	fz	fz	fz	fz	fz	fz	fz	fz	fz	fz	fz
H	HARDENED STEEL	Vc (m/min)												
1.1	46-55	105	0.015	0.017	0.02	0.025	0.025	0.03	0.03	0.035	0.035	0.04	0.04	0.045
1.2	56-60	80	0.012	0.014	0.018	0.022	0.022	0.028	0.028	0.032	0.032	0.038	0.038	0.042
1.3	60-65	70	0.01	0.012	0.015	0.02	0.02	0.025	0.025	0.03	0.03	0.035	0.035	0.04
1.4	66-70	60	0.007	0.009	0.012	0.017	0.015	0.02	0.02	0.025	0.025	0.03	0.03	0.035

Dimension	Ø8		Ø10		Ø12		Ø16		Ø20	
Infeed in mm	ae=0.05xD	ae=0.04xD	ae=0.05xD	ae=0.04xD	ae=0.05xD	ae=0.04xD	ae=0.05xD	ae=0.04xD	ae=0.05xD	ae=0.04xD
	ap=L2 max	ap=0.04xD	ap=L2 max	ap=0.04xD	ap=L2 max	ap=0.04xD	ap=L2 max	ap=0.04xD	ap=L2 max	ap=0.04xD
Application										

Material	Hardness in HRC	Feed (mm/Z)	fz	fz	fz	fz	fz	fz	fz	fz	fz	fz
H	HARDENED STEEL	Vc (m/min)										
1.1	46-55	105	0.045	0.05	0.05	0.055	0.055	0.07	0.07	0.075	0.08	0.085
1.2	56-60	80	0.042	0.048	0.047	0.053	0.052	0.065	0.065	0.07	0.075	0.08
1.3	60-65	70	0.04	0.045	0.045	0.05	0.05	0.06	0.06	0.065	0.07	0.075
1.4	66-70	60	0.03	0.035	0.035	0.045	0.04	0.055	0.05	0.06	0.06	0.07

ADVICE | By using multipass milling the maximum infeed (ae, ap) is 0.5x corner radius!

Cooling	
Tolerance	e8
Coating	AlphaDura Navy

Strategy	HSC	HPC	
Application			
Features	HA		

- Ultrafine carbide grade specially developed for machining hardened steels
 - Adapted rake angle for safe milling up to 70 HRC
 - Defined cutting edge preparation for homogeneous wear
-
- Multipass milling of 3D contours
-
- Radius tolerance $r \leq 1.5 \text{ mm}$: $\pm 0.003 \text{ mm}$
 - Radius tolerance $r > 1.5 \text{ mm}$: $\pm 0.005 \text{ mm}$

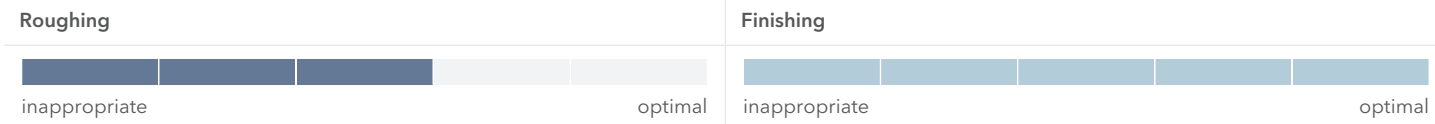
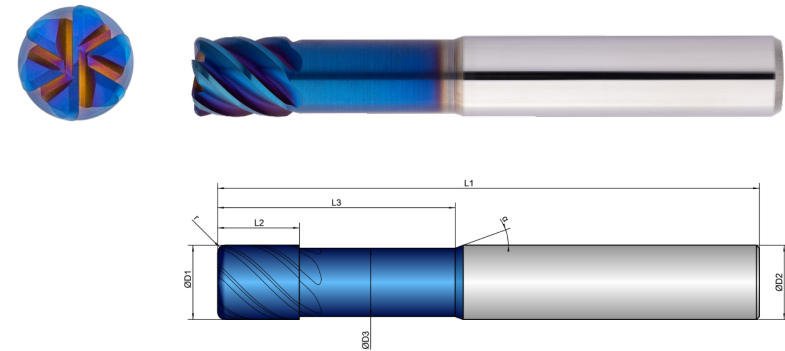

K202253	D1 mm Ø	D3 mm Ø	L2 mm	L3 mm	L1 mm	D2 mm Ø	z #	r mm		α °
3/0,3	3.0	2.7	4.0	14.0	50.0	3.0	4	0.30	45	20
3/0,5	3.0	2.7	4.0	14.0	50.0	3.0	4	0.50	45	20
3/1	3.0	2.7	4.0	14.0	50.0	3.0	4	1.00	45	20
4/0,4	4.0	3.7	5.0	16.0	50.0	4.0	4	0.40	45	20
4/0,5	4.0	3.7	5.0	16.0	50.0	4.0	4	0.50	45	20
4/1	4.0	3.7	5.0	16.0	50.0	4.0	4	1.00	45	20
5/0,5	5.0	4.6	6.0	18.0	54.0	5.0	4	0.50	45	20
5/1	5.0	4.6	6.0	18.0	54.0	5.0	4	1.00	45	20
6/0,5	6.0	5.5	7.0	21.0	58.0	6.0	6	0.50	45	20
6/0,8	6.0	5.5	7.0	21.0	58.0	6.0	6	0.80	45	20
6/1	6.0	5.5	7.0	21.0	58.0	6.0	6	1.00	45	20
6/1,5	6.0	5.5	7.0	21.0	58.0	6.0	6	1.50	45	20
8/0,5	8.0	7.4	9.0	27.0	64.0	8.0	6	0.50	45	20

K202253	D1 mm Ø	D3 mm Ø	L2 mm	L3 mm	L1 mm	D2 mm Ø	z #	r mm		α °
8/0,8	8.0	7.4	9.0	27.0	64.0	8.0	6	0.80	45	20
8/1	8.0	7.4	9.0	27.0	64.0	8.0	6	1.00	45	20
8/1,5	8.0	7.4	9.0	27.0	64.0	8.0	6	1.50	45	20
8/2	8.0	7.4	9.0	27.0	64.0	8.0	6	2.00	45	20
8/3	8.0	7.4	9.0	27.0	64.0	8.0	6	3.00	45	20
10/0,5	10.0	9.2	11.0	32.0	73.0	10.0	6	0.50	45	20
10/0,8	10.0	9.2	11.0	32.0	73.0	10.0	6	0.80	45	20
10/1	10.0	9.2	11.0	32.0	73.0	10.0	6	1.00	45	20
10/1,5	10.0	9.2	11.0	32.0	73.0	10.0	6	1.50	45	20
10/2	10.0	9.2	11.0	32.0	73.0	10.0	6	2.00	45	20
10/3	10.0	9.2	11.0	32.0	73.0	10.0	6	3.00	45	20
12/0,5	12.0	11.0	12.0	38.0	84.0	12.0	6	0.50	45	20
12/1	12.0	11.0	12.0	38.0	84.0	12.0	6	1.00	45	20
12/1,5	12.0	11.0	12.0	38.0	84.0	12.0	6	1.50	45	20
12/2	12.0	11.0	12.0	38.0	84.0	12.0	6	2.00	45	20
12/3	12.0	11.0	12.0	38.0	84.0	12.0	6	3.00	45	20
16/1	16.0	15.0	16.0	44.0	93.0	16.0	6	1.00	45	20
16/2	16.0	15.0	16.0	44.0	93.0	16.0	6	2.00	45	20
16/3	16.0	15.0	16.0	44.0	93.0	16.0	6	3.00	45	20
20/1	20.0	18.5	20.0	50.0	104.0	20.0	6	1.00	45	20
20/2,5	20.0	18.5	20.0	50.0	104.0	20.0	6	2.50	45	20

Dimension	Ø 3		Ø 4		Ø 5		Ø 6		Ø 8		Ø 10	
Infeed in mm	ae= 0.05xD	ae= 0.04xD	ae= 0.05xD	ae= 0.04xD	ae= 0.05xD	ae= 0.04xD	ae= 0.05xD	ae= 0.04xD	ae= 0.05xD	ae= 0.04xD	ae= 0.05xD	ae= 0.04xD
	ap= L2 max	ap= 0.04xD	ap= L2 max	ap= 0.04xD	ap= L2 max	ap= 0.04xD	ap= L2 max	ap= 0.04xD	ap= L2 max	ap= 0.04xD	ap= L2 max	ap= 0.04xD
Application												

Material	Hardness in HRC	Feed (mm/Z)	fz	fz	fz	fz	fz	fz	fz	fz	fz	fz	fz	fz
H	HARDENED STEEL	Vc (m/min)												
1.1	46-55	125	0.025	0.03	0.03	0.035	0.035	0.04	0.04	0.045	0.045	0.05	0.05	0.055
1.2	56-60	95	0.022	0.028	0.028	0.032	0.032	0.038	0.038	0.042	0.042	0.048	0.047	0.053
1.3	60-65	80	0.02	0.025	0.025	0.03	0.03	0.035	0.035	0.04	0.04	0.045	0.045	0.05
1.4	66-70	70	0.015	0.02	0.02	0.025	0.025	0.03	0.03	0.035	0.03	0.035	0.035	0.045

Dimension	Ø 12		Ø 16		Ø 20	
Infeed in mm	ae= 0.05xD	ae= 0.04xD	ae= 0.05xD	ae= 0.04xD	ae= 0.05xD	ae= 0.04xD
	ap= L2 max	ap= 0.04xD	ap= L2 max	ap= 0.04xD	ap= L2 max	ap= 0.04xD
Application						

Material	Hardness in HRC	Feed (mm/Z)	fz	fz	fz	fz	fz	fz
H	HARDENED STEEL	Vc (m/min)						
1.1	46-55	125	0.055	0.07	0.07	0.075	0.08	0.085
1.2	56-60	95	0.052	0.065	0.065	0.07	0.075	0.08
1.3	60-65	80	0.05	0.06	0.06	0.065	0.07	0.075
1.4	66-70	70	0.04	0.055	0.05	0.06	0.06	0.07

ADVICE | By using multipass milling the maximum infeed (ae, ap) is 0.5x corner radius!

Cooling	
Tolerance	e8
Coating	AlphaDura Navy

Strategy	ETC	HSC	HPC	 Expert
Application				
Features	HA			

- Ultrafine carbide grade specially developed for machining hardened steels
- Adapted rake angle for safe milling up to 70 HRC
- Defined cutting edge preparation for homogeneous wear

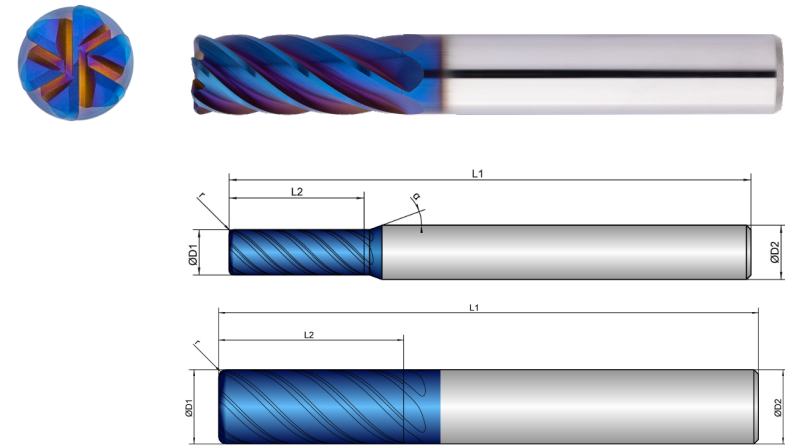

- Multipass milling of 3D contours

- Radius tolerance $r \leq 1.5$ mm: ± 0.003 mm
- Radius tolerance $r > 1.5$ mm: ± 0.005 mm
- Reduce the axial depth of cutting with increasing hardness

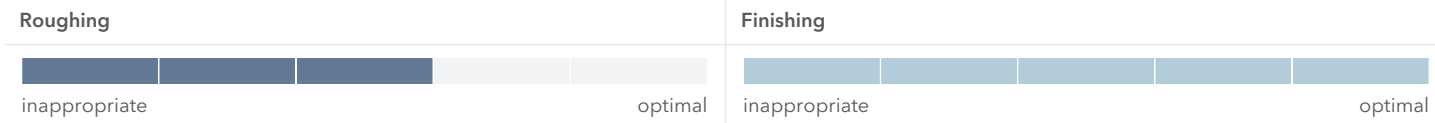

	D1	L2	L1	D2	z	r	α
K202293	mm \varnothing	mm	mm	mm \varnothing	#	mm	$^\circ$
5/0,5	5.0	15.0	58.0	6.0	6	0.50	12
5/1	5.0	15.0	58.0	6.0	6	1.00	12
6/0,5	6.0	16.0	58.0	6.0	6	0.50	37.5
6/1	6.0	16.0	58.0	6.0	6	1.00	37.5
8/0,5	8.0	22.0	70.0	8.0	6	0.50	37.5
8/1	8.0	22.0	70.0	8.0	6	1.00	37.5
10/0,5	10.0	25.0	73.0	10.0	6	0.50	37.5
10/1	10.0	25.0	73.0	10.0	6	1.00	37.5
10/1,5	10.0	25.0	73.0	10.0	6	1.50	37.5
12/0,5	12.0	28.0	84.0	12.0	6	0.50	37.5
12/1	12.0	28.0	84.0	12.0	6	1.00	37.5
12/1,5	12.0	28.0	84.0	12.0	6	1.50	37.5
14/1	14.0	30.0	84.0	14.0	6	1.00	37.5
16/1	16.0	36.0	93.0	16.0	8	1.00	37.5
16/2	16.0	36.0	93.0	16.0	8	2.00	37.5
18/1	18.0	36.0	93.0	18.0	10	1.00	37.5
20/1	20.0	41.0	104.0	20.0	10	1.00	37.5
20/2	20.0	41.0	104.0	20.0	10	2.00	37.5

Dimension	Ø5		Ø6		Ø8		Ø10		Ø12		Ø14	
Infeed in mm	ae=0.05xD	ae=0.04xD	ae=0.05xD	ae=0.04xD	ae=0.05xD	ae=0.04xD	ae=0.05xD	ae=0.04xD	ae=0.05xD	ae=0.04xD	ae=0.05xD	ae=0.04xD
Application	ap=L2 max	ap=0.04xD	ap=L2 max	ap=0.04xD	ap=L2 max	ap=0.04xD	ap=L2 max	ap=0.04xD	ap=L2 max	ap=0.04xD	ap=L2 max	ap=0.04xD

Material	Hardness in HRC	Feed (mm/Z)	fz	fz	fz	fz	fz	fz	fz	fz	fz	fz	fz	
H	HARDENED STEEL	Vc (m/min)												
1.1	46-55	125	0.035	0.04	0.04	0.045	0.045	0.05	0.05	0.055	0.055	0.07	0.055	0.07
1.2	56-60	95	0.032	0.038	0.038	0.042	0.042	0.048	0.047	0.053	0.052	0.065	0.052	0.065
1.3	60-65	80	0.03	0.035	0.035	0.04	0.04	0.045	0.045	0.05	0.05	0.06	0.05	0.06
1.4	66-70	70	0.025	0.03	0.03	0.035	0.03	0.035	0.035	0.045	0.04	0.055	0.04	0.055

Dimension	Ø16		Ø18		Ø20	
Infeed in mm	ae=0.05xD	ae=0.04xD	ae=0.05xD	ae=0.04xD	ae=0.05xD	ae=0.04xD
Application	ap=L2 max	ap=0.04xD	ap=L2 max	ap=0.04xD	ap=L2 max	ap=0.04xD

Material	Hardness in HRC	Feed (mm/Z)	fz	fz	fz	fz	fz	
H	HARDENED STEEL	Vc (m/min)						
1.1	46-55	125	0.07	0.075	0.07	0.075	0.08	0.085
1.2	56-60	95	0.065	0.07	0.065	0.07	0.075	0.08
1.3	60-65	80	0.06	0.065	0.06	0.065	0.07	0.075
1.4	66-70	70	0.05	0.06	0.05	0.06	0.06	0.07

ADVICE | By using multipass milling the maximum infeed (ae, ap) is 0.5x corner radius!



STILL CAN'T FIND A SUITABLE MILLING CUTTER?

No problem - simply customize an existing tool. Using our configurator for special milling cutters, you can customize existing tools to your needs in an instant or create your own tools based on predefined types.

WE WILL RESPOND TO ALL REQUESTS SUBMITTED VIA THE CONFIGURATOR WITHIN ONE WORKING DAY AT THE LATEST



Cooling	
Tolerance	e8
Coating	AlphaDura Navy

Strategy	ETC	HPC	
Application			
Features	HA		



- Ultrafine carbide grade specially developed for machining hardened steels
- Adapted rake angle for safe milling up to 70 HRC
- Defined cutting edge preparation for homogeneous wear

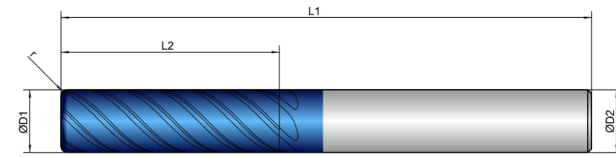

- Multipass milling of 3D contours

- Radius tolerance $r \leq 1.5$ mm: ± 0.003 mm
- Radius tolerance $r > 1.5$ mm: ± 0.005 mm
- Reduce the axial depth of cutting with increasing hardness

Roughing



Finishing



	D1	L2	L1	D2	z	r	
K202303	mm	mm	mm	mm	#	mm	°
6/0,5	6.0	21.0	65.0	6.0	6	0.50	37.5
6/1	6.0	21.0	65.0	6.0	6	1.00	37.5
8/0,5	8.0	28.0	75.0	8.0	6	0.50	37.5
8/1	8.0	28.0	75.0	8.0	6	1.00	37.5
10/0,5	10.0	35.0	85.0	10.0	6	0.50	37.5
10/1	10.0	35.0	85.0	10.0	6	1.00	37.5
10/1,5	10.0	35.0	85.0	10.0	6	1.50	37.5
12/0,5	12.0	45.0	100.0	12.0	6	0.50	37.5
12/1	12.0	45.0	100.0	12.0	6	1.00	37.5
12/1,5	12.0	45.0	100.0	12.0	6	1.50	37.5
14/1	14.0	45.0	100.0	14.0	6	1.00	37.5
16/1	16.0	50.0	110.0	16.0	8	1.00	37.5
16/2	16.0	50.0	110.0	16.0	8	2.00	37.5
18/1	18.0	54.0	114.0	18.0	10	1.00	37.5
20/1	20.0	55.0	126.0	20.0	10	1.00	37.5
20/2	20.0	55.0	126.0	20.0	10	2.00	37.5

Dimension	Ø6		Ø8		Ø10		Ø12		Ø14		Ø16	
Infeed in mm	ae=0.05xD	ae=0.04xD	ae=0.05xD	ae=0.04xD	ae=0.05xD	ae=0.04xD	ae=0.05xD	ae=0.04xD	ae=0.05xD	ae=0.04xD	ae=0.05xD	ae=0.04xD
Application	ap=L2 max	ap=0.04xD	ap=L2 max	ap=0.04xD	ap=L2 max	ap=0.04xD	ap=L2 max	ap=0.04xD	ap=L2 max	ap=0.04xD	ap=L2 max	ap=0.04xD

Material	Hardness in HRC	Feed (mm/Z)	Vc (m/min)												
H	HARDENED STEEL		fz	fz	fz	fz	fz	fz	fz	fz	fz	fz	fz	fz	fz
1.1	46-55	115	0.04	0.045	0.045	0.05	0.05	0.055	0.055	0.07	0.055	0.07	0.07	0.075	
1.2	56-60	90	0.038	0.042	0.042	0.048	0.047	0.053	0.052	0.065	0.052	0.065	0.065	0.07	
1.3	60-65	75	0.035	0.04	0.04	0.045	0.045	0.05	0.05	0.06	0.05	0.06	0.06	0.065	
1.4	66-70	65	0.03	0.035	0.03	0.035	0.035	0.045	0.04	0.055	0.04	0.055	0.05	0.06	

Dimension	Ø18		Ø20	
Infeed in mm	ae=0.05xD	ae=0.04xD	ae=0.05xD	ae=0.04xD
Application	ap=L2 max	ap=0.04xD	ap=L2 max	ap=0.04xD

Material	Hardness in HRC	Feed (mm/Z)	Vc (m/min)			
H	HARDENED STEEL		fz	fz	fz	fz
1.1	46-55	115	0.07	0.075	0.08	0.085
1.2	56-60	90	0.065	0.07	0.075	0.08
1.3	60-65	75	0.06	0.065	0.07	0.075
1.4	66-70	65	0.05	0.06	0.06	0.07

ADVICE | By using multipass milling the maximum infeed (ae, ap) is 0.5x corner radius!

Cooling	
Tolerance	e8
Coating	AlphaDura Navy

Strategy	ETC	HPC			
Application					
Features	HA				

- Ultrafine carbide grade specially developed for machining hardened steels
 - Adapted rake angle for safe milling up to 70 HRC
 - Defined cutting edge preparation for homogeneous wear
-
- Multipass milling of 3D contours
-
- Radius tolerance $r \leq 1.5$ mm: ± 0.003 mm
 - Radius tolerance $r > 1.5$ mm: ± 0.005 mm
 - Reduce the axial depth of cutting with increasing hardness

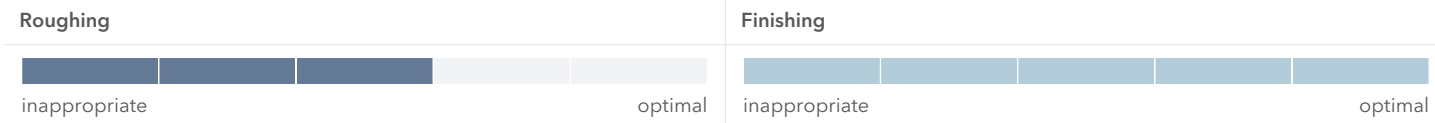
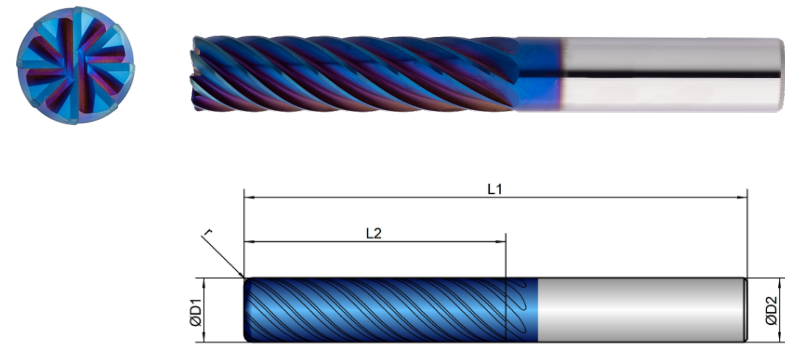

K202307	D1	L2	L1	D2	z	r	
	 mm ø	 mm	 mm	 mm ø	 #	 mm	
16/1	16.0	65.0	125.0	16.0	8	1.00	37.5
16/2	16.0	65.0	125.0	16.0	8	2.00	37.5
20/1	20.0	70.0	135.0	20.0	10	1.00	37.5
20/2	20.0	70.0	135.0	20.0	10	2.00	37.5

Dimension	Ø16		Ø20	
Infeed in mm	ae= 0.03xD	ae= 0.03xD	ae= 0.03xD	ae= 0.03xD
	ap= L2 max	ap= 0.03xD	ap= L2 max	ap= 0.03xD
Application				

H	Material	Hardness in HRC	Feed (mm/Z)	Vc (m/min)			
				fz	fz	fz	fz
1.1	HARDENED STEEL	46-55	105	0.06	0.065	0.07	0.075
1.2		56-60	80	0.055	0.06	0.065	0.07
1.3		60-65	65	0.055	0.06	0.065	0.07
1.4		66-70	55	0.05	0.055	0.06	0.065

ADVICE | By using multipass milling the maximum infeed (ae, ap) is 0.5x corner radius!

Cooling	
Tolerance	h9
Coating	AlphaDura Navy

Strategy	HSC	
Application		
Features	HA ≠ 0,5xD R	

- Ultrafine carbide grade specially developed for machining hardened steels
- Geometry with tangential transitions for HSC milling
- Defined cutting edge preparation for homogeneous wear

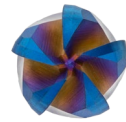

- For roughing and finishing under HSC conditions

- Check programming radius and ap max. according to the variant table

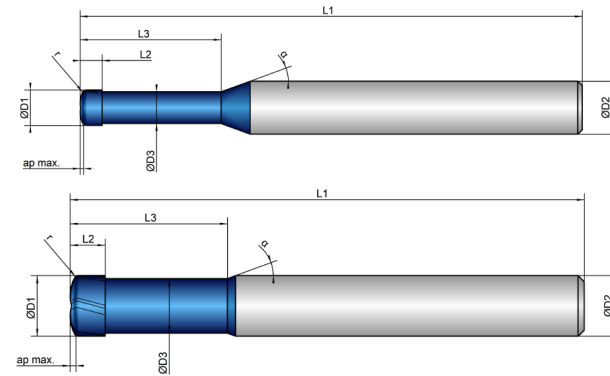

Dimension	Ø2	Ø3	Ø4	Ø5	Ø6	Ø8	Ø10	Ø12	Ø16
Infeed in mm	ae= 1xD ap _{max} = 0.06mm	ae= 1xD ap _{max} = 0.1mm	ae= 1xD ap _{max} = 0.15mm	ae= 1xD ap _{max} = 0.17mm	ae= 1xD ap _{max} = 0.2mm	ae= 1xD ap _{max} = 0.25mm	ae= 1xD ap _{max} = 0.3mm	ae= 1xD ap _{max} = 0.4mm	ae= 1xD ap _{max} = 0.5mm
Application									

H	Material	Hardness in HRC	Feed (mm/Z)	Vc (m/min)								
				fz	fz	fz	fz	fz	fz	fz	fz	
1.1	HARDENED STEEL	46-55	160	0.028	0.05	0.07	0.08	0.09	0.11	0.13	0.16	0.22
1.2		56-60	120	0.025	0.045	0.065	0.075	0.085	0.1	0.12	0.15	0.2
1.3		60-65	85	0.022	0.04	0.06	0.07	0.08	0.09	0.11	0.14	0.18
1.4		66-70	55	0.017	0.035	0.055	0.065	0.075	0.08	0.1	0.13	0.16

Roughing



Finishing



K207013	D1	D3	L2	L3	L1	D2	z					α
	mm Ø	mm Ø	mm	mm	mm	mm Ø	#					
2	2.0	1.7	1.5	13.0	54.0	6.0	2	0.3	0.06	12	20	
3	3.0	2.7	1.5	15.0	54.0	6.0	2	0.3	0.10	12	20	
4	4.0	3.6	2.5	16.0	57.0	6.0	2	0.5	0.15	12	20	
5	5.0	4.6	3.5	18.0	65.0	6.0	4	0.5	0.17	12	20	
6	6.0	5.2	3.5	20.0	65.0	6.0	4	1.0	0.20	12	20	
8	8.0	7.0	4.8	24.0	70.0	8.0	5	1.5	0.25	12	20	
10	10.0	9.0	5.8	26.0	85.0	10.0	5	2.0	0.30	12	20	
12	12.0	11.0	6.8	30.0	93.0	12.0	5	2.0	0.40	12	20	
16	16.0	14.5	8.8	35.0	100.0	16.0	5	2.5	0.50	12	20	

Cooling	
Tolerance	h9
Coating	AlphaDura Navy

Strategy	HSC	
Application		
Features	HA ≠ 0,5xD R	

- Ultrafine carbide grade specially developed for machining hardened steels
- Geometry with tangential transitions for HSC milling
- Defined cutting edge preparation for homogeneous wear

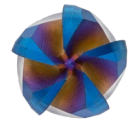

- Long version for deeper cavities
- For roughing and finishing under HSC conditions

- Check programming radius and ap max. according to the variant table

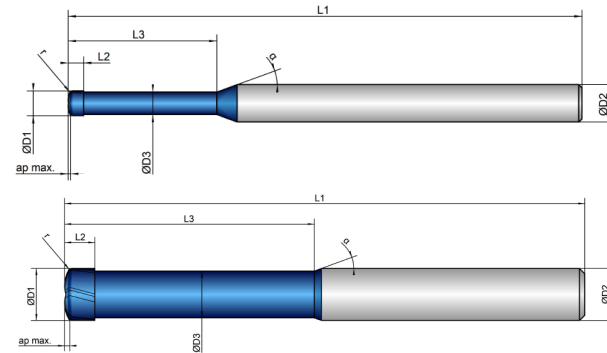

Roughing



Finishing



	D1	D3	L2	L3	L1	D2	z				α
K207018	mm \varnothing	mm \varnothing	mm	mm	mm	mm \varnothing	#	mm	mm max	°	°
2	2.0	1.7	1.5	18.0	75.0	6.0	2	0.3	0.06	12	20
3	3.0	2.7	1.5	20.0	75.0	6.0	2	0.3	0.10	12	20
4	4.0	3.6	2.5	24.0	83.0	6.0	2	0.5	0.15	12	20
5	5.0	4.6	3.5	28.0	100.0	6.0	4	0.5	0.17	12	20
6	6.0	5.2	3.5	28.0	100.0	6.0	4	1.0	0.20	12	20
8	8.0	7.0	4.8	40.0	100.0	8.0	5	1.5	0.25	12	20
10	10.0	9.0	5.8	48.0	100.0	10.0	5	2.0	0.30	12	20
12	12.0	11.0	6.8	56.0	119.0	12.0	5	2.0	0.40	12	20
16	16.0	14.5	8.8	65.0	150.0	16.0	5	2.5	0.50	12	20

Dimension	Ø2	Ø3	Ø4	Ø5	Ø6	Ø8	Ø10	Ø12	Ø16
Infeed in mm	ae= 1xD ap _{max} = 0.06mm	ae= 1xD ap _{max} = 0.1mm	ae= 1xD ap _{max} = 0.15mm	ae= 1xD ap _{max} = 0.17mm	ae= 1xD ap _{max} = 0.2mm	ae= 1xD ap _{max} = 0.25mm	ae= 1xD ap _{max} = 0.3mm	ae= 1xD ap _{max} = 0.4mm	ae= 1xD ap _{max} = 0.5mm
Application									

H	Material	Hardness in HRC	Feed (mm/Z)	Vc (m/min)								
				fz	fz	fz	fz	fz	fz	fz	fz	
1.1	HARDENED STEEL	46-55	140	0.028	0.05	0.07	0.08	0.09	0.11	0.13	0.16	0.22
1.2		56-60	100	0.025	0.045	0.065	0.075	0.085	0.1	0.12	0.15	0.2
1.3		60-65	75	0.022	0.04	0.06	0.07	0.08	0.09	0.11	0.14	0.18
1.4		66-70	45	0.017	0.035	0.055	0.065	0.075	0.08	0.1	0.13	0.16

Cooling	
Tolerance	f8
Coating	AlphaDura Navy

Strategy	HSC	
Application		
Features	HA 1xD R	

- Ultrafine carbide grade specially developed for machining hardened steels
 - Adapted rake angle for safe milling up to 70 HRC
 - Defined cutting edge preparation for homogeneous wear
- Radius tolerance $r \leq 2 \text{ mm}$: $\pm 0.003 \text{ mm}$
 - Radius tolerance $r > 2 \text{ mm}$: $\pm 0.005 \text{ mm}$

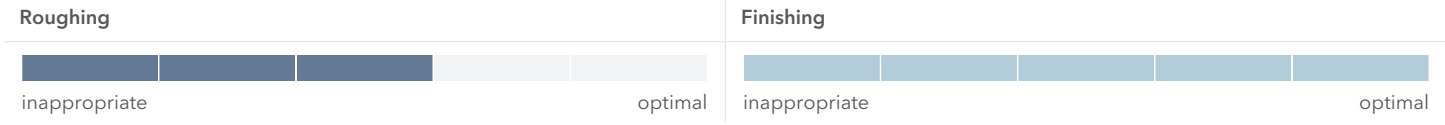
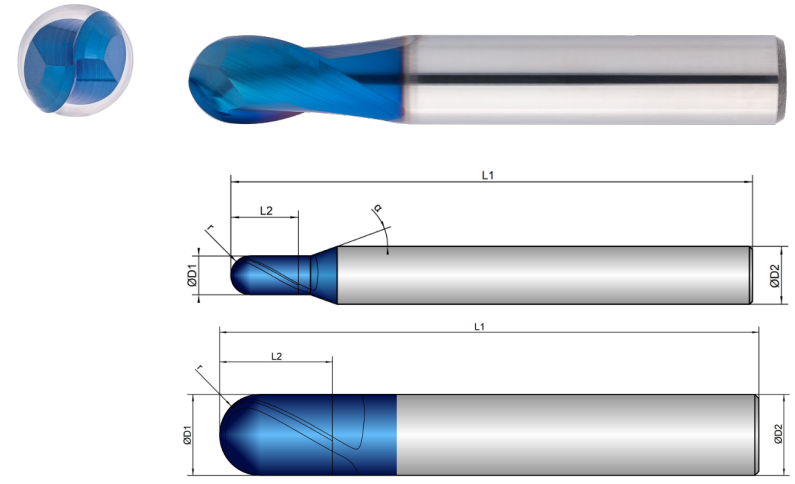

K203103	D1 mm ø	L2 mm	L1 mm	D2 mm ø	z #	r mm		α °
0,1/3	0.1	0.2	38.0	3.0	2	0.05	30	8
0,15/3	0.15	0.3	38.0	3.0	2	0.075	30	8
0,2/3	0.2	0.4	38.0	3.0	2	0.10	30	8
0,25/3	0.25	0.5	38.0	3.0	2	0.125	30	8
0,3/3	0.3	1.0	38.0	3.0	2	0.15	30	8
0,35/3	0.35	1.0	38.0	3.0	2	0.175	30	8
0,4/3	0.4	1.0	38.0	3.0	2	0.20	30	8
0,5/3	0.5	1.5	38.0	3.0	2	0.25	30	8
0,5/6	0.5	1.5	54.0	6.0	2	0.25	30	12
0,6/3	0.6	1.5	38.0	3.0	2	0.30	30	8
0,7/3	0.7	2.0	38.0	3.0	2	0.35	30	8
0,8/3	0.8	2.0	38.0	3.0	2	0.40	30	8

K203103	D1 mm ø	L2 mm	L1 mm	D2 mm ø	z #	r mm		α °
0,9/3	0.9	2.5	38.0	3.0	2	0.45	30	8
1/3	1.0	2.0	50.0	3.0	2	0.50	30	8
1/6	1.0	2.0	54.0	6.0	2	0.50	30	12
1,1/3	1.1	3.0	50.0	3.0	2	0.55	30	8
1,2/3	1.2	3.0	50.0	3.0	2	0.60	30	8
1,4/3	1.4	3.0	50.0	3.0	2	0.70	30	8
1,5/3	1.5	3.0	50.0	3.0	2	0.75	30	8
1,5/6	1.5	3.0	54.0	6.0	2	0.75	30	12
1,6/3	1.6	4.0	50.0	3.0	2	0.80	30	8
1,8/3	1.8	4.0	50.0	3.0	2	0.90	30	8
2/3	2.0	4.0	50.0	3.0	2	1.00	30	8
2/6	2.0	4.0	54.0	6.0	2	1.00	30	12
2,5/3	2.5	5.0	50.0	3.0	2	1.25	30	8
2,5/6	2.5	5.0	54.0	6.0	2	1.25	30	12
3/3	3.0	6.0	50.0	3.0	2	1.50	30	
3/6	3.0	6.0	54.0	6.0	2	1.50	30	12
4/4	4.0	7.0	54.0	4.0	2	2.00	30	
4/6	4.0	7.0	54.0	6.0	2	2.00	30	12
5/5	5.0	8.0	54.0	5.0	2	2.50	30	
5/6	5.0	8.0	54.0	6.0	2	2.50	30	12
6/6	6.0	10.0	54.0	6.0	2	3.00	30	
8/8	8.0	12.0	59.0	8.0	2	4.00	30	
10/10	10.0	14.0	67.0	10.0	2	5.00	30	
12/12	12.0	16.0	74.0	12.0	2	6.00	30	
14/14	14.0	18.0	75.0	14.0	2	7.00	30	
16/16	16.0	22.0	83.0	16.0	2	8.00	30	
20/20	20.0	26.0	93.0	20.0	2	10.00	30	



Dimension	Ø0.1	Ø0.15	Ø0.2	Ø0.25	Ø0.3	Ø0.35	Ø0.4	Ø0.5	Ø0.6	Ø0.7
Infeed in mm	ae=0.05xD ap=0.05xD	ae=0.05xD ap=0.05xD	ae=0.05xD ap=0.05xD	ae=0.05xD ap=0.05xD	ae=0.05xD ap=0.05xD	ae=0.05xD ap=0.05xD	ae=0.05xD ap=0.05xD	ae=0.05xD ap=0.05xD	ae=0.05xD ap=0.05xD	ae=0.05xD ap=0.05xD
Application										

Material	Hardness in HRC	Feed (mm/Z)	fz	fz	fz	fz	fz	fz	fz	fz	fz	fz
H	HARDENED STEEL	Vc (m/min)										
1.1	46-55	110	0.014	0.014	0.017	0.017	0.018	0.018	0.019	0.024	0.024	0.024
1.2	56-60	70	0.012	0.012	0.016	0.016	0.017	0.017	0.018	0.023	0.023	0.023
1.3	60-65	50	0.01	0.01	0.014	0.014	0.015	0.015	0.017	0.022	0.022	0.022
1.4	66-70	40	0.008	0.008	0.012	0.012	0.013	0.013	0.014	0.019	0.019	0.019

Dimension	Ø0.8	Ø0.9	Ø1	Ø1.1	Ø1.2	Ø1.4	Ø1.5	Ø1.6	Ø1.8	Ø2
Infeed in mm	ae=0.05xD ap=0.05xD	ae=0.05xD ap=0.05xD	ae=0.05xD ap=0.05xD	ae=0.05xD ap=0.05xD	ae=0.05xD ap=0.05xD	ae=0.05xD ap=0.05xD	ae=0.05xD ap=0.05xD	ae=0.05xD ap=0.05xD	ae=0.05xD ap=0.05xD	ae=0.05xD ap=0.05xD
Application										

Material	Hardness in HRC	Feed (mm/Z)	fz	fz	fz	fz	fz	fz	fz	fz	fz	fz
H	HARDENED STEEL	Vc (m/min)										
1.1	46-55	110	0.026	0.029	0.03	0.03	0.033	0.033	0.034	0.034	0.036	0.036
1.2	56-60	70	0.025	0.025	0.029	0.029	0.032	0.032	0.033	0.033	0.035	0.035
1.3	60-65	50	0.024	0.024	0.028	0.028	0.03	0.03	0.032	0.032	0.034	0.034
1.4	66-70	40	0.021	0.021	0.024	0.024	0.026	0.026	0.028	0.028	0.03	0.03

Dimension	Ø2.5	Ø3	Ø4	Ø5	Ø6	Ø8	Ø10	Ø12	Ø14	Ø16
Infeed in mm	ae=0.05xD ap=0.05xD	ae=0.05xD ap=0.05xD	ae=0.05xD ap=0.05xD	ae=0.05xD ap=0.05xD	ae=0.05xD ap=0.05xD	ae=0.05xD ap=0.05xD	ae=0.05xD ap=0.05xD	ae=0.05xD ap=0.05xD	ae=0.05xD ap=0.05xD	ae=0.05xD ap=0.05xD
Application										

Material	Hardness in HRC	Feed (mm/Z)	fz	fz	fz	fz	fz	fz	fz	fz	fz	fz
H	HARDENED STEEL	Vc (m/min)										
1.1	46-55	160	0.04	0.044	0.055	0.08	0.09	0.11	0.13	0.14	0.14	0.15
1.2	56-60	125	0.038	0.042	0.052	0.075	0.085	0.105	0.12	0.13	0.13	0.14
1.3	60-65	110	0.035	0.04	0.05	0.07	0.08	0.1	0.11	0.12	0.12	0.13
1.4	66-70	85	0.03	0.035	0.045	0.06	0.07	0.085	0.09	0.1	0.1	0.11

Dimension	Ø20
Infeed in mm	ae=0.05xD ap=0.05xD
Application	

Material	Hardness in HRC	Feed (mm/Z)	fz
H	HARDENED STEEL	Vc (m/min)	
1.1	46-55	160	0.18
1.2	56-60	125	0.17
1.3	60-65	110	0.15
1.4	66-70	85	0.13

DO YOU HAVE BLUNT MILLING CUTTERS THAT URGENTLY NEED REGRINDING?



➔ DISCOVER OUR H&V REGRINDING SERVICE

... and have your tools reconditioned to their original state!



Cooling	
Tolerance	f8
Coating	AlphaDura Navy

Strategy	HSC	
Application		
Features	HA 1,5xD R	



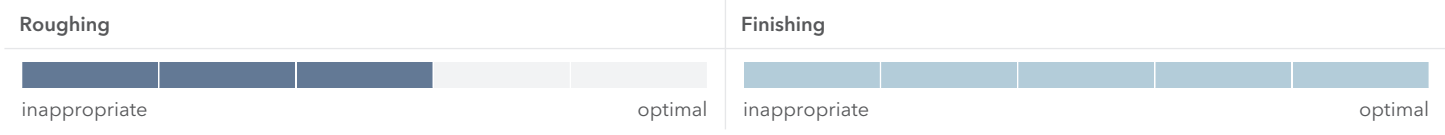
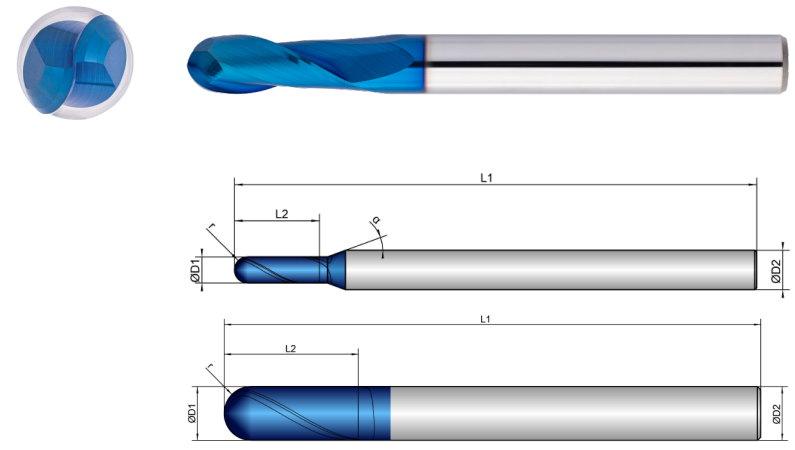







- Ultrafine carbide grade specially developed for machining hardened steels
 - Adapted rake angle for safe milling up to 70 HRC
 - Defined cutting edge preparation for homogeneous wear
-
- Long version with extra long cutting length
-
- Radius tolerance $r \leq 2$ mm: ± 0.003 mm
 - Radius tolerance $r > 2$ mm: ± 0.005 mm







K203143	D1 mm Ø	L2 mm	L1 mm	D2 mm Ø	z #	r mm		α °
0,5/3	0.5	1.5	75.0	3.0	2	0.25	30	8
0,5/6	0.5	1.5	80.0	6.0	2	0.25	30	12
1/3	1.0	3.0	75.0	3.0	2	0.50	30	8
1/6	1.0	3.0	80.0	6.0	2	0.50	30	8
1,5/3	1.5	4.0	75.0	3.0	2	0.75	30	8
1,5/6	1.5	4.0	80.0	6.0	2	0.75	30	12
2/3	2.0	6.0	75.0	3.0	2	1.00	30	8
2/6	2.0	6.0	80.0	6.0	2	1.00	30	12
2,5/3	2.5	8.0	75.0	3.0	2	1.25	30	8
2,5/6	2.5	8.0	80.0	6.0	2	1.25	30	12
3/3	3.0	10.0	75.0	3.0	2	1.50	30	

K203143	D1 mm Ø	L2 mm	L1 mm	D2 mm Ø	z #	r mm		α °
3/6	3.0	10.0	80.0	6.0	2	1.50	30	12
4/4	4.0	13.0	75.0	4.0	2	2.00	30	
4/6	4.0	13.0	80.0	6.0	2	2.00	30	12
5/5	5.0	14.0	75.0	5.0	2	2.50	30	
5/6	5.0	14.0	100.0	6.0	2	2.50	30	12
6/6	6.0	16.0	100.0	6.0	2	3.00	30	
8/8	8.0	22.0	100.0	8.0	2	4.00	30	
10/10	10.0	25.0	100.0	10.0	2	5.00	30	
12/12	12.0	26.0	100.0	12.0	2	6.00	30	
14/14	14.0	26.0	100.0	14.0	2	7.00	30	
16/16	16.0	30.0	150.0	16.0	2	8.00	30	
20/20	20.0	40.0	150.0	20.0	2	10.00	30	



Dimension	Ø0.5	Ø1	Ø1.5	Ø2	Ø2.5	Ø3	Ø4	Ø5	Ø6	Ø8
Infeed in mm	ae=0.05xD ap=0.05xD	ae=0.05xD ap=0.05xD	ae=0.05xD ap=0.05xD	ae=0.05xD ap=0.05xD	ae=0.05xD ap=0.05xD	ae=0.05xD ap=0.05xD	ae=0.05xD ap=0.05xD	ae=0.05xD ap=0.05xD	ae=0.05xD ap=0.05xD	ae=0.05xD ap=0.05xD
Application										

Material	Hardness in HRC	Feed (mm/Z)	fz	fz	fz	fz	fz	fz	fz	fz	fz	fz
H	HARDENED STEEL	Vc (m/min)										
1.1	46-55	160	0.02	0.024	0.029	0.03	0.033	0.036	0.045	0.065	0.075	0.09
1.2	56-60	125	0.019	0.023	0.028	0.029	0.032	0.034	0.042	0.06	0.07	0.085
1.3	60-65	110	0.018	0.022	0.026	0.028	0.03	0.032	0.04	0.055	0.065	0.08
1.4	66-70	85	0.015	0.019	0.022	0.024	0.026	0.028	0.035	0.05	0.06	0.075

Dimension	Ø10	Ø12	Ø14	Ø16	Ø20
Infeed in mm	ae=0.05xD ap=0.05xD	ae=0.05xD ap=0.05xD	ae=0.05xD ap=0.05xD	ae=0.05xD ap=0.05xD	ae=0.05xD ap=0.05xD
Application					

Material	Hardness in HRC	Feed (mm/Z)	fz	fz	fz	fz	fz
H	HARDENED STEEL	Vc (m/min)					
1.1	46-55	160	0.1	0.12	0.12	0.125	0.15
1.2	56-60	125	0.095	0.11	0.11	0.115	0.14
1.3	60-65	110	0.09	0.1	0.1	0.105	0.12
1.4	66-70	85	0.085	0.09	0.09	0.1	0.11

Cooling	
Tolerance	f8
Coating	AlphaDura Navy

Strategy	HSC	
Application		
Features	HA 1xD	

- Ultrafine carbide grade specially developed for machining hardened steels
- Adapted rake angle for safe milling up to 70 HRC
- Defined cutting edge preparation for homogeneous wear

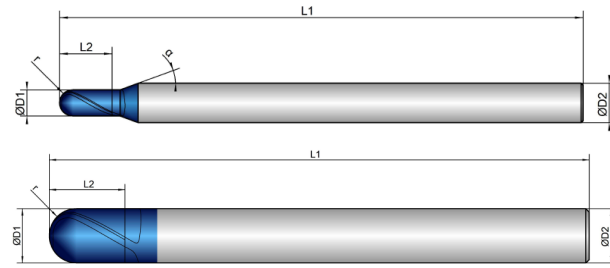

- Long version for deeper cavities

- Radius tolerance $r \leq 2$ mm: ± 0.003 mm
- Radius tolerance $r > 2$ mm: ± 0.005 mm

Roughing



Finishing



	D1	L2	L1	D2	z	r		α
K203153	mm \varnothing	mm	mm	mm \varnothing	#	mm	\circ	\circ
1/6	1.0	2.0	80.0	6.0	2	0.50	30	12
1,5/6	1.5	3.0	80.0	6.0	2	0.75	30	12
2/6	2.0	4.0	80.0	6.0	2	1.00	30	12
2,5/6	2.5	5.0	80.0	6.0	2	1.25	30	12
3/3	3.0	5.0	75.0	3.0	2	1.50	30	
3/6	3.0	5.0	80.0	6.0	2	1.50	30	12
4/4	4.0	8.0	75.0	4.0	2	2.00	30	
4/6	4.0	8.0	80.0	6.0	2	2.00	30	12
5/5	5.0	9.0	75.0	5.0	2	2.50	30	
5/6	5.0	9.0	100.0	6.0	2	2.50	30	12
6/6	6.0	10.0	100.0	6.0	2	3.00	30	
8/8	8.0	12.0	100.0	8.0	2	4.00	30	
10/10	10.0	14.0	100.0	10.0	2	5.00	30	
12/12	12.0	16.0	100.0	12.0	2	6.00	30	
14/14	14.0	18.0	100.0	14.0	2	7.00	30	
16/16	16.0	22.0	150.0	16.0	2	8.00	30	
20/20	20.0	26.0	150.0	20.0	2	10.00	30	

Dimension	Ø1	Ø1.5	Ø2	Ø2.5	Ø3	Ø4	Ø5	Ø6	Ø8	Ø10
Infeed in mm	ae=0.05xD ap=0.05xD	ae=0.05xD ap=0.05xD	ae=0.05xD ap=0.05xD	ae=0.05xD ap=0.05xD	ae=0.05xD ap=0.05xD	ae=0.05xD ap=0.05xD	ae=0.05xD ap=0.05xD	ae=0.05xD ap=0.05xD	ae=0.05xD ap=0.05xD	ae=0.05xD ap=0.05xD
Application										

H	Material	Hardness in HRC	Feed (mm/Z)	Vc (m/min)									
				fz	fz	fz	fz	fz	fz	fz	fz	fz	fz
1.1	HARDENED STEEL	46-55	145	0.024	0.029	0.03	0.033	0.036	0.045	0.065	0.075	0.09	0.1
1.2	HARDENED STEEL	56-60	115	0.023	0.028	0.029	0.032	0.034	0.042	0.06	0.07	0.085	0.095
1.3	HARDENED STEEL	60-65	100	0.022	0.026	0.028	0.03	0.032	0.04	0.055	0.065	0.08	0.09
1.4	HARDENED STEEL	66-70	75	0.019	0.022	0.024	0.026	0.028	0.035	0.05	0.06	0.075	0.085

Dimension	Ø12	Ø14	Ø16	Ø20
Infeed in mm	ae=0.05xD ap=0.05xD	ae=0.05xD ap=0.05xD	ae=0.05xD ap=0.05xD	ae=0.05xD ap=0.05xD
Application				

H	Material	Hardness in HRC	Feed (mm/Z)	Vc (m/min)			
				fz	fz	fz	fz
1.1	HARDENED STEEL	46-55	145	0.12	0.12	0.125	0.15
1.2	HARDENED STEEL	56-60	115	0.11	0.11	0.115	0.14
1.3	HARDENED STEEL	60-65	100	0.1	0.1	0.105	0.12
1.4	HARDENED STEEL	66-70	75	0.09	0.09	0.1	0.11



STILL CAN'T FIND A SUITABLE MILLING CUTTER?

No problem - simply customize an existing tool. Using our configurator for special milling cutters, you can customize existing tools to your needs in an instant or create your own tools based on predefined types.

WE WILL RESPOND TO ALL REQUESTS SUBMITTED VIA THE CONFIGURATOR WITHIN ONE WORKING DAY AT THE LATEST



Cooling	
Tolerance	f8
Coating	AlphaDura Navy

Strategy	HSC	
Application		
Features	HA 1xD R	

- Ultrafine carbide grade specially developed for machining hardened steels
- Adapted rake angle for safe milling up to 70 HRC
- Defined cutting edge preparation for homogeneous wear

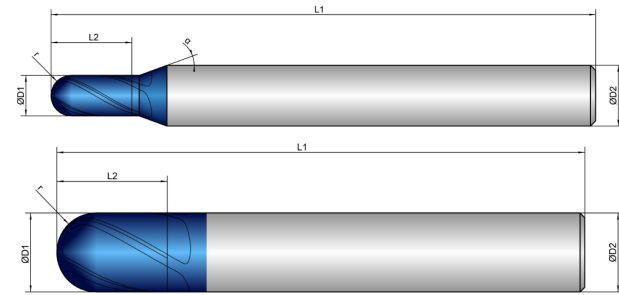

- 4 cutting edges to the center
- Radius tolerance $r \leq 2 \text{ mm}$: $\pm 0.003 \text{ mm}$
- Radius tolerance $r > 2 \text{ mm}$: $\pm 0.005 \text{ mm}$

Roughing



Finishing



	D1	L2	L1	D2	z	r		α
K203333	mm \varnothing	mm	mm	mm \varnothing	#	mm	\circ	\circ
2/3	2.0	4.0	50.0	3.0	4	1.00	30	8
2/6	2.0	4.0	54.0	6.0	4	1.00	30	12
2,5/6	2.5	5.0	54.0	6.0	4	1.25	30	12
3/3	3.0	5.0	50.0	3.0	4	1.50	30	
3/6	3.0	5.0	54.0	6.0	4	1.50	30	12
4/4	4.0	8.0	54.0	4.0	4	2.00	30	
4/6	4.0	8.0	54.0	6.0	4	2.00	30	12
5/5	5.0	9.0	54.0	5.0	4	2.50	30	
5/6	5.0	9.0	54.0	6.0	4	2.50	30	12
6/6	6.0	10.0	54.0	6.0	4	3.00	30	
7/8	7.0	12.0	59.0	8.0	4	3.50	30	
8/8	8.0	12.0	59.0	8.0	4	4.00	30	
9/10	9.0	14.0	67.0	10.0	4	4.50	30	
10/10	10.0	14.0	67.0	10.0	4	5.00	30	
12/12	12.0	16.0	74.0	12.0	4	6.00	30	
14/14	14.0	18.0	75.0	14.0	4	7.00	30	
16/16	16.0	22.0	83.0	16.0	4	8.00	30	
20/20	20.0	26.0	93.0	20.0	4	10.00	30	

Dimension	$\varnothing 2$	$\varnothing 2.5$	$\varnothing 3$	$\varnothing 4$	$\varnothing 5$	$\varnothing 6$	$\varnothing 7$	$\varnothing 8$	$\varnothing 9$	$\varnothing 10$
Infeed in mm	ae=0.05xD ap=0.05xD	ae=0.05xD ap=0.05xD	ae=0.05xD ap=0.05xD	ae=0.05xD ap=0.05xD	ae=0.05xD ap=0.05xD	ae=0.05xD ap=0.05xD	ae=0.05xD ap=0.05xD	ae=0.05xD ap=0.05xD	ae=0.05xD ap=0.05xD	ae=0.05xD ap=0.05xD
Application										

Material	Hardness in HRC	Feed (mm/Z)	fz	fz	fz	fz	fz	fz	fz	fz	fz	fz
H	HARDENED STEEL	Vc (m/min)										
1.1	46-55	160	0.03	0.031	0.034	0.045	0.06	0.07	0.07	0.09	0.09	0.1
1.2	56-60	125	0.029	0.03	0.033	0.042	0.058	0.068	0.068	0.085	0.085	0.095
1.3	60-65	110	0.028	0.029	0.032	0.04	0.055	0.065	0.065	0.08	0.08	0.09
1.4	66-70	85	0.024	0.025	0.028	0.035	0.05	0.06	0.06	0.07	0.07	0.08

Dimension	$\varnothing 12$	$\varnothing 14$	$\varnothing 16$	$\varnothing 20$
Infeed in mm	ae=0.05xD ap=0.05xD	ae=0.05xD ap=0.05xD	ae=0.05xD ap=0.05xD	ae=0.05xD ap=0.05xD
Application				

Material	Hardness in HRC	Feed (mm/Z)	fz	fz	fz	fz
H	HARDENED STEEL	Vc (m/min)				
1.1	46-55	160	0.12	0.12	0.125	0.15
1.2	56-60	125	0.11	0.11	0.115	0.14
1.3	60-65	110	0.1	0.1	0.105	0.12
1.4	66-70	85	0.09	0.09	0.095	0.11



Cooling	
Tolerance	f8
Coating	AlphaDura Navy

Strategy	HSC	
Application		
Features	HA 1xD R	

- Ultrafine carbide grade specially developed for machining hardened steels
- Adapted rake angle for safe milling up to 70 HRC
- Defined cutting edge preparation for homogeneous wear

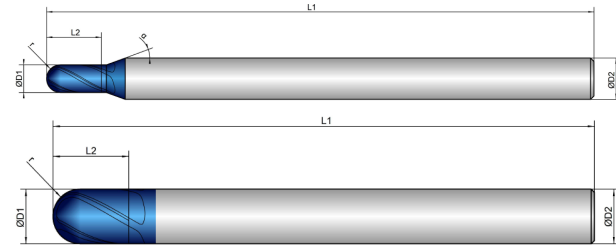

- Long version for deeper cavities

- 4 cutting edges to the center
- Radius tolerance $r \leq 2$ mm: ± 0.003 mm
- Radius tolerance $r > 2$ mm: ± 0.005 mm

Roughing



Finishing



	D1	L2	L1	D2	z	r		α
K203343	mm \varnothing	mm	mm	mm \varnothing	#	mm	°	°
2/3	2.0	4.0	75.0	3.0	4	1.00	30	8
2/6	2.0	4.0	80.0	6.0	4	1.00	30	12
2,5/6	2.5	5.0	80.0	6.0	4	1.25	30	12
3/3	3.0	5.0	75.0	3.0	4	1.50	30	
3/6	3.0	5.0	80.0	6.0	4	1.50	30	12
4/4	4.0	8.0	75.0	4.0	4	2.00	30	
4/6	4.0	8.0	80.0	6.0	4	2.00	30	12
5/5	5.0	9.0	75.0	5.0	4	2.50	30	
5/6	5.0	9.0	100.0	6.0	4	2.50	30	12
6/6	6.0	10.0	100.0	6.0	4	3.00	30	
8/8	8.0	12.0	100.0	8.0	4	4.00	30	
10/10	10.0	14.0	100.0	10.0	4	5.00	30	
12/12	12.0	16.0	100.0	12.0	4	6.00	30	
14/14	14.0	18.0	100.0	14.0	4	7.00	30	
16/16	16.0	22.0	150.0	16.0	4	8.00	30	
20/20	20.0	26.0	150.0	20.0	4	10.00	30	

Dimension	Ø2	Ø2,5	Ø3	Ø4	Ø5	Ø6	Ø8	Ø10	Ø12	Ø14
Infeed in mm	ae=0,05xD ap=0,05xD	ae=0,05xD ap=0,05xD	ae=0,05xD ap=0,05xD	ae=0,05xD ap=0,05xD	ae=0,05xD ap=0,05xD	ae=0,05xD ap=0,05xD	ae=0,05xD ap=0,05xD	ae=0,05xD ap=0,05xD	ae=0,05xD ap=0,05xD	ae=0,05xD ap=0,05xD
Application										

H	Material	Hardness in HRC	Feed (mm/Z)	Vc (m/min)									
				fz	fz	fz	fz	fz	fz	fz	fz	fz	fz
1.1	HARDENED STEEL	46-55	145	0,03	0,031	0,034	0,045	0,06	0,07	0,09	0,1	0,12	0,12
1.2	HARDENED STEEL	56-60	115	0,029	0,03	0,033	0,042	0,058	0,068	0,085	0,095	0,11	0,11
1.3	HARDENED STEEL	60-65	100	0,028	0,029	0,032	0,04	0,055	0,065	0,08	0,09	0,1	0,1
1.4	HARDENED STEEL	66-70	75	0,024	0,025	0,028	0,035	0,05	0,06	0,07	0,08	0,09	0,09

Dimension	Ø16	Ø20
Infeed in mm	ae=0,05xD ap=0,05xD	ae=0,05xD ap=0,05xD
Application		

H	Material	Hardness in HRC	Feed (mm/Z)	Vc (m/min)	
				fz	fz
1.1	HARDENED STEEL	46-55	145	0,125	0,15
1.2	HARDENED STEEL	56-60	115	0,115	0,14
1.3	HARDENED STEEL	60-65	100	0,105	0,12
1.4	HARDENED STEEL	66-70	75	0,095	0,11

Cooling	
Tolerance	-
Coating	AlphaDura Navy

Strategy	
Application	
Features	

- Ultrafine carbide grade specially developed for machining hardened steels
- Defined cutting edge preparation for homogeneous wear
- Specially for deburring hardened steels

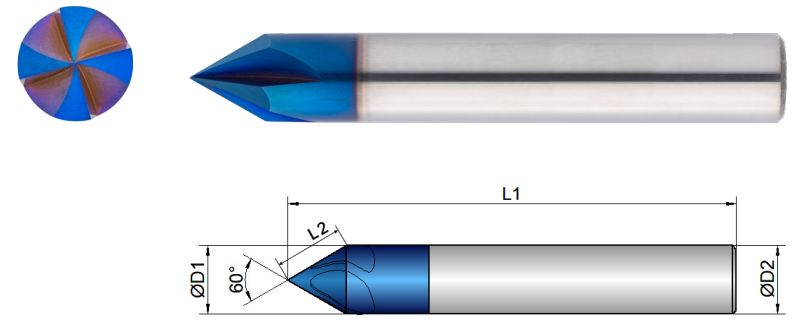

Roughing		Finishing	

	D1 mm ø	L2 mm	L1 mm	D2 mm ø	z #
K205153					
3	3.0	2.9	50.0	3.0	3
4	4.0	3.9	50.0	4.0	4
6	6.0	5.9	50.0	6.0	4
8	8.0	7.9	59.0	8.0	4
10	10.0	9.9	66.0	10.0	4
12	12.0	11.9	73.0	12.0	4

Dimension	Ø3	Ø4	Ø6	Ø8	Ø10	Ø12
Infeed in mm	ae= 0.1xD ap= L2 max	ae= 0.1xD ap= L2 max	ae= 0.1xD ap= L2 max	ae= 0.1xD ap= L2 max	ae= 0.1xD ap= L2 max	ae= 0.1xD ap= L2 max
Application						

H	Material	Hardness in HRC	Feed (mm/Z)						
			Vc (m/min)	fz	fz	fz	fz	fz	fz
1.1	HARDENED STEEL	46-55	105	0.02	0.025	0.03	0.04	0.05	0.06
1.2		56-60	95	0.015	0.02	0.025	0.035	0.045	0.055
1.3		60-65	70	0.012	0.018	0.022	0.03	0.04	0.05
1.4		66-70	45	0.01	0.015	0.018	0.02	0.03	0.04

Cooling	
Tolerance	-
Coating	AlphaDura Navy

Strategy	
Application	
Features	



- Ultrafine carbide grade specially developed for machining hardened steels
- Defined cutting edge preparation for homogeneous wear
- Specially for deburring hardened steels

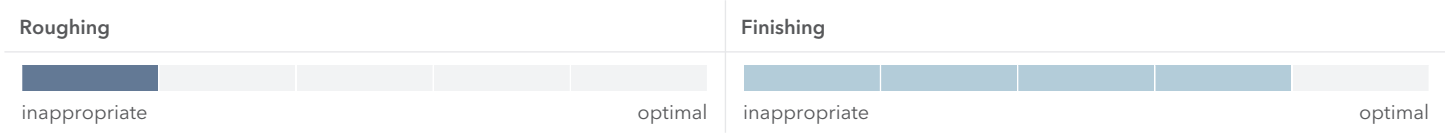
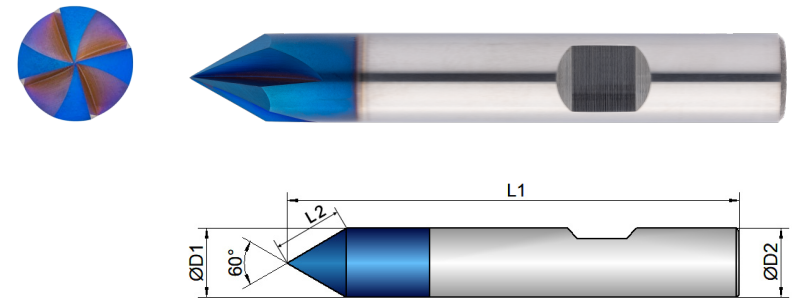

	D1 mm ø	L2 mm	L1 mm	D2 mm ø	z #
K205154					
6	6.0	5.9	50.0	6.0	4
8	8.0	7.9	59.0	8.0	4
10	10.0	9.9	66.0	10.0	4
12	12.0	11.9	73.0	12.0	4

Dimension	Ø6	Ø8	Ø10	Ø12
Infeed in mm	ae= 0.1xD ap= L2 max	ae= 0.1xD ap= L2 max	ae= 0.1xD ap= L2 max	ae= 0.1xD ap= L2 max
Application				

Material	Hardness in HRC	Feed (mm/Z)	fz	fz	fz	fz
H	HARDENED STEEL	Vc (m/min)				
1.1	46-55	105	0.03	0.04	0.05	0.06
1.2	56-60	95	0.025	0.035	0.045	0.055
1.3	60-65	70	0.022	0.03	0.04	0.05
1.4	66-70	45	0.018	0.02	0.03	0.04

Cooling

Tolerance -

Coating AlphaDura Navy

Strategy

Application

Features

- Ultrafine carbide grade specially developed for machining hardened steels
- Defined cutting edge preparation for homogeneous wear
- Specially for deburring hardened steels

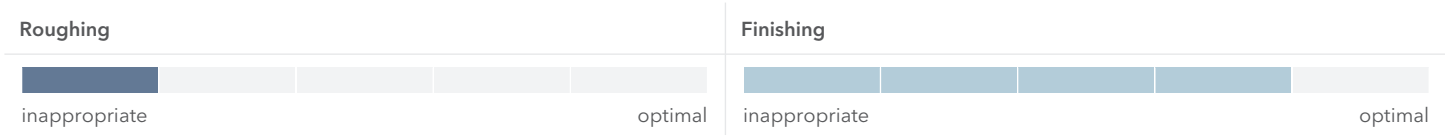
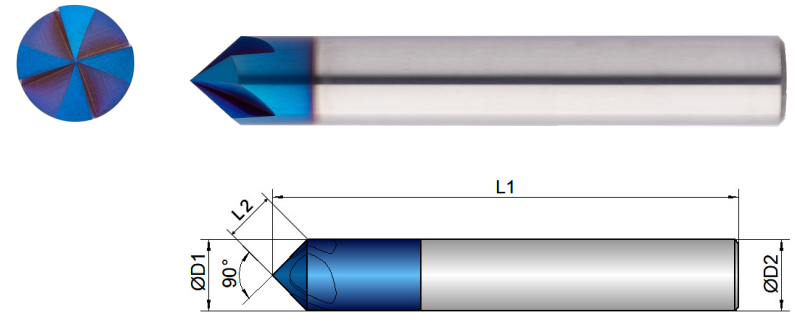

	D1 mm ø	L2 mm	L1 mm	D2 mm ø	z #
K205163					
3	3.0	2.1	50.0	3.0	3
4	4.0	2.8	50.0	4.0	4
6	6.0	4.2	50.0	6.0	4
8	8.0	5.6	59.0	8.0	4
10	10.0	7.0	66.0	10.0	4
12	12.0	8.5	73.0	12.0	4

Dimension	Ø3	Ø4	Ø6	Ø8	Ø10	Ø12
Infeed in mm	ae= 0.1xD ap= L2 max	ae= 0.1xD ap= L2 max	ae= 0.1xD ap= L2 max	ae= 0.1xD ap= L2 max	ae= 0.1xD ap= L2 max	ae= 0.1xD ap= L2 max
Application						

H	Material	Hardness in HRC	Feed (mm/Z)						
			Vc (m/min)	fz	fz	fz	fz	fz	fz
1.1	HARDENED STEEL	46-55	105	0.02	0.025	0.03	0.04	0.05	0.06
1.2		56-60	95	0.015	0.02	0.025	0.035	0.045	0.055
1.3		60-65	70	0.012	0.018	0.022	0.03	0.04	0.05
1.4		66-70	45	0.01	0.015	0.018	0.02	0.03	0.04

Cooling	
Tolerance	-
Coating	AlphaDura Navy

Strategy

Application

Features **HB**

- Ultrafine carbide grade specially developed for machining hardened steels
- Defined cutting edge preparation for homogeneous wear
- Specially for deburring hardened steels

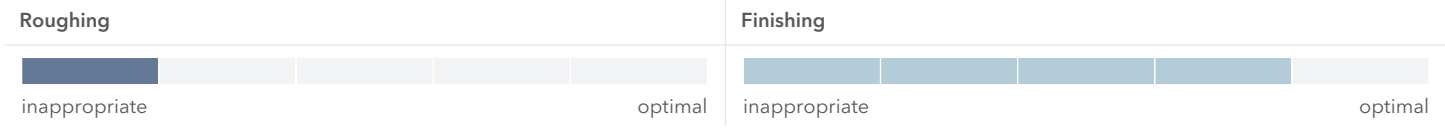
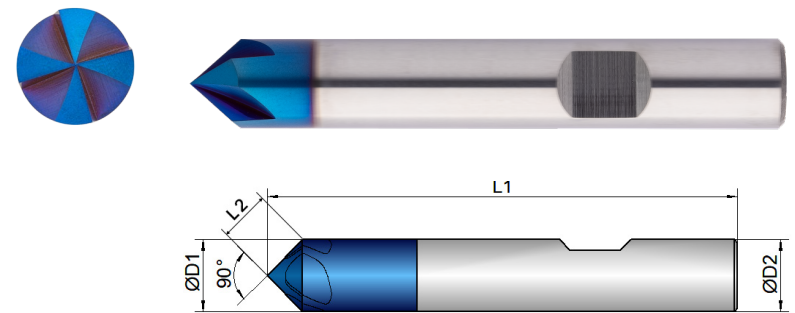

	D1 mm ø	L2 mm	L1 mm	D2 mm ø	z #
K205164					
6	6.0	4.2	50.0	6.0	4
8	8.0	5.6	59.0	8.0	4
10	10.0	7.0	66.0	10.0	4
12	12.0	8.5	73.0	12.0	4

Dimension	Ø6	Ø8	Ø10	Ø12
Infeed in mm	ae= 0.1xD ap= L2 max	ae= 0.1xD ap= L2 max	ae= 0.1xD ap= L2 max	ae= 0.1xD ap= L2 max
Application				

H	Material	Hardness in HRC	Feed (mm/Z)				
			Vc (m/min)	fz	fz	fz	fz
1.1	HARDENED STEEL	46-55	105	0.03	0.04	0.05	0.06
1.2		56-60	95	0.025	0.035	0.045	0.055
1.3		60-65	70	0.022	0.03	0.04	0.05
1.4		66-70	45	0.018	0.02	0.03	0.04



STILL CAN'T FIND A SUITABLE MILLING CUTTER?

No problem - simply customize an existing tool. Using our configurator for special milling cutters, you can customize existing tools to your needs in an instant or create your own tools based on predefined types.

WE WILL RESPOND TO ALL REQUESTS SUBMITTED VIA THE CONFIGURATOR WITHIN ONE WORKING DAY AT THE LATEST

Cooling	
Tolerance	V1
Coating	AlphaDura Navy

Strategy	
Application	
Features	HA

- Ultrafine carbide grade specially developed for machining hardened steels
- Defined cutting edge preparation for homogeneous wear
- For the attachment of radii to components

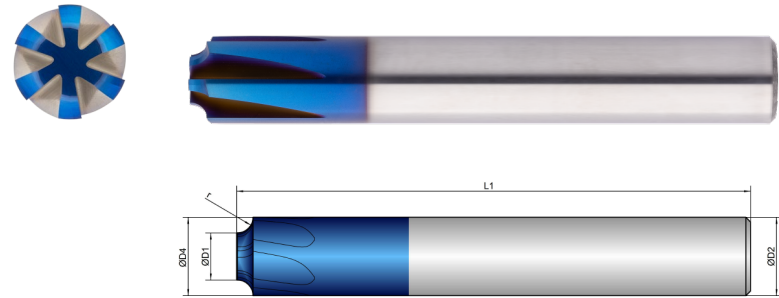

Roughing					Finishing				
inappropriate					optimal				

K204108	D5 mm Ø	D4 mm Ø	L1 mm	D2 mm Ø	z #	r mm
3/0,5	3	4	50.0	4.0	6	0.50
3,2/0,4	3.2	4	50.0	4.0	6	0.40
3,4/0,3	3.4	4	50.0	4.0	6	0.30
3,6/0,2	3.6	4	50.0	4.0	6	0.20
4/1	4	6	50.0	6.0	6	1.00
4,4/0,8	4.4	6	50.0	6.0	6	0.80
4,8/0,6	4.8	6	50.0	6.0	6	0.60
5/10	5	25	100.0	25.0	6	10.00
6/2	6	10	66.0	10.0	6	2.00
6/3	6	12	73.0	12.0	6	3.00
7/1,5	7	10	66.0	10.0	6	1.50
7/2,5	7	12	73.0	12.0	6	2.50
7/4,5	7	16	80.0	16.0	6	4.50
8/4	8	16	80.0	16.0	6	4.00
8/6	8	20	93.0	20.0	6	6.00
9/3,5	9	16	80.0	16.0	6	3.50
9/8	9	25	100.0	25.0	6	8.00
10/5	10	20	93.0	20.0	6	5.00

Dimension	Ø3.6 R0.2	Ø3.4 R0.3	Ø3.2 R0.4	Ø3 R0.5	Ø4.8 R0.6	Ø4.4 R0.8	Ø4 R1	Ø7 R1.5	Ø6 R2	Ø7 R2.5
Infeed in mm	ae=rmax ap=rmax	ae=rmax ap=rmax	ae=rmax ap=rmax	ae=rmax ap=rmax	ae=rmax ap=rmax	ae=rmax ap=rmax	ae=rmax ap=rmax	ae=rmax ap=rmax	ae=rmax ap=rmax	ae=rmax ap=rmax
Application										

Material	Hardness in HRC	Feed (mm/Z)	fz	fz	fz	fz	fz	fz	fz	fz	fz	fz
H HARDENED STEEL		Vc (m/min)										
1.1	46-55	50	0.02	0.02	0.02	0.02	0.024	0.024	0.024	0.026	0.03	0.034
1.2	56-60	45	0.018	0.018	0.018	0.018	0.022	0.022	0.022	0.024	0.028	0.032
1.3	60-65	40	0.016	0.016	0.016	0.016	0.02	0.02	0.02	0.022	0.026	0.03
1.4	66-70	30	0.01	0.01	0.01	0.01	0.012	0.012	0.012	0.014	0.018	0.022

Material	Strength (N/mm²)	Feed (mm/Z)	fz	fz	fz	fz	fz	fz	fz	fz	fz	fz
M STAINLESS STEEL		Vc (m/min)										
1.1	ferritic/martensitic <850	95	0.03	0.03	0.03	0.03	0.035	0.035	0.035	0.035	0.045	0.045
2.1	austenitic <650	85	0.028	0.028	0.028	0.028	0.033	0.033	0.033	0.033	0.042	0.042
2.2	austenitic <750	80	0.026	0.026	0.026	0.026	0.031	0.031	0.031	0.031	0.04	0.04
3.1	DUPLEX STEEL super austenitic <1100	60	0.02	0.02	0.02	0.02	0.022	0.022	0.022	0.022	0.03	0.03

Dimension	Ø6 R3	Ø9 R3.5	Ø8 R4	Ø7 R4.5	Ø10 R5	Ø8 R6	Ø9 R8	Ø5 R10
Infeed in mm	ae=rmax ap=rmax	ae=rmax ap=rmax	ae=rmax ap=rmax	ae=rmax ap=rmax	ae=rmax ap=rmax	ae=rmax ap=rmax	ae=rmax ap=rmax	ae=rmax ap=rmax
Application								

Material	Hardness in HRC	Feed (mm/Z)	fz	fz	fz	fz	fz	fz	fz	fz
H HARDENED STEEL		Vc (m/min)								
1.1	46-55	50	0.034	0.036	0.036	0.036	0.038	0.038	0.042	0.042
1.2	56-60	45	0.032	0.034	0.034	0.034	0.036	0.036	0.04	0.04
1.3	60-65	40	0.03	0.032	0.032	0.032	0.034	0.034	0.038	0.038
1.4	66-70	30	0.022	0.022	0.022	0.022	0.024	0.024	0.028	0.028

Material	Strength (N/mm²)	Feed (mm/Z)	fz	fz	fz	fz	fz	fz	fz	fz
M STAINLESS STEEL		Vc (m/min)								
1.1	ferritic/martensitic <850	95	0.05	0.055	0.055	0.055	0.06	0.06	0.065	0.065
2.1	austenitic <650	85	0.048	0.053	0.053	0.053	0.058	0.058	0.063	0.063
2.2	austenitic <750	80	0.045	0.05	0.05	0.05	0.055	0.055	0.06	0.06
3.1	DUPLEX STEEL super austenitic <1100	60	0.035	0.04	0.04	0.04	0.045	0.045	0.05	0.05

ADVICE | The values marked in turquoise are side applications! Please use the arithmetic average from D2 and D1 to calculate cutting datas. For example tool Ø5 R10, D1=Ø5; R=10 calculated diameter = Ø15 Formula: D1+R= Result Example: 5mm+10mm=15mm

Cooling	
Tolerance	d04
Coating	AlphaDura Navy





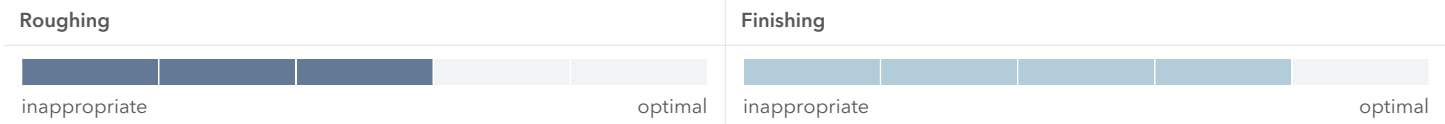
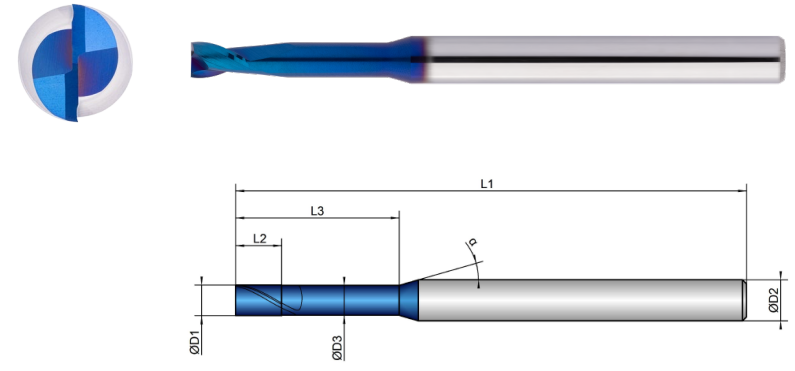



Strategy	HSC	
Application		
Features	HA	

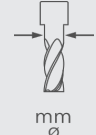



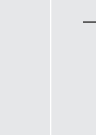



- Ultrafine carbide grade developed for machining hardened steels
 - Optimized face geometry for long tool life and highest dimensional accuracy
 - Reinforced core for milling up to 70 HRC
- Tolerance D1: -0.001/-0.006 mm
 - Tolerance D3: 0/-0.02 mm

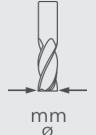

K201122	D1 mm ø	D3 mm ø	L2 mm	L3 mm	L1 mm	D2 mm ø	z #		α °
0,2X0,5	0.2	0.18	0.3	0.5	45.0	4.0	2	30	16
0,2X1	0.2	0.18	0.3	1.0	45.0	4.0	2	30	16
0,2X1,5	0.2	0.18	0.3	1.5	45.0	4.0	2	30	16
0,3X1	0.3	0.28	0.4	1.0	45.0	4.0	2	30	16
0,3X2	0.3	0.28	0.4	2.0	45.0	4.0	2	30	16
0,3X3	0.3	0.28	0.4	3.0	45.0	4.0	2	30	16
0,3X6	0.3	0.28	0.4	6.0	45.0	4.0	2	30	16
0,3X9	0.3	0.28	0.4	9.0	45.0	4.0	2	30	16
0,4X2	0.4	0.38	0.6	2.0	45.0	4.0	2	30	16
0,4X3	0.4	0.38	0.6	3.0	45.0	4.0	2	30	16
0,4X4	0.4	0.38	0.6	4.0	45.0	4.0	2	30	16
0,4X5	0.4	0.38	0.6	5.0	45.0	4.0	2	30	16
0,4X8	0.4	0.38	0.6	8.0	45.0	4.0	2	30	16
0,4X12	0.4	0.38	0.6	12.0	45.0	4.0	2	30	16
0,5X2	0.5	0.48	0.7	2.0	45.0	4.0	2	30	16

K201122	D1 mm ø	D3 mm ø	L2 mm	L3 mm	L1 mm	D2 mm ø	z #		α °
0,5X4	0.5	0.48	0.7	4.0	45.0	4.0	2	30	16
0,5X6	0.5	0.48	0.7	6.0	45.0	4.0	2	30	16
0,5X8	0.5	0.48	0.7	8.0	45.0	4.0	2	30	16
0,5X10	0.5	0.48	0.7	10.0	50.0	4.0	2	30	16
0,5X15	0.5	0.48	0.7	15.0	50.0	4.0	2	30	16
0,6X2	0.6	0.58	0.9	2.0	45.0	4.0	2	30	16
0,6X4	0.6	0.58	0.9	4.0	45.0	4.0	2	30	16
0,6X6	0.6	0.58	0.9	6.0	45.0	4.0	2	30	16
0,6X8	0.6	0.58	0.9	8.0	45.0	4.0	2	30	16
0,6X10	0.6	0.58	0.9	10.0	45.0	4.0	2	30	16
0,6X12	0.6	0.58	0.9	12.0	50.0	4.0	2	30	16
0,6X18	0.6	0.58	0.9	18.0	50.0	4.0	2	30	16
0,7X2	0.7	0.68	1.0	2.0	45.0	4.0	2	30	16
0,7X4	0.7	0.68	1.0	4.0	45.0	4.0	2	30	16
0,7X6	0.7	0.68	1.0	6.0	45.0	4.0	2	30	16
0,7X8	0.7	0.68	1.0	8.0	45.0	4.0	2	30	16
0,7X10	0.7	0.68	1.0	10.0	50.0	4.0	2	30	16
0,8X4	0.8	0.78	1.2	4.0	45.0	4.0	2	30	16
0,8X6	0.8	0.78	1.2	6.0	45.0	4.0	2	30	16
0,8X8	0.8	0.78	1.2	8.0	45.0	4.0	2	30	16
0,8X10	0.8	0.78	1.2	10.0	50.0	4.0	2	30	16
0,8X12	0.8	0.78	1.2	12.0	50.0	4.0	2	30	16
0,8X16	0.8	0.78	1.2	16.0	50.0	4.0	2	30	16
0,8X24	0.8	0.78	1.2	24.0	60.0	4.0	2	30	16
0,9X4	0.9	0.88	1.3	4.0	45.0	4.0	2	30	16
0,9X6	0.9	0.88	1.3	6.0	45.0	4.0	2	30	16
0,9X8	0.9	0.88	1.3	8.0	45.0	4.0	2	30	16
0,9X10	0.9	0.88	1.3	10.0	45.0	4.0	2	30	16
0,9X15	0.9	0.88	1.3	15.0	50.0	4.0	2	30	16

K201122	D1  mm ø	D3  mm ø	L2  mm	L3  mm	L1  mm	D2  mm ø	z  #	 °	α  °
1X4	1.0	0.95	1.5	4.0	45.0	4.0	2	30	16
1X6	1.0	0.95	1.5	6.0	45.0	4.0	2	30	16
1X8	1.0	0.95	1.5	8.0	45.0	4.0	2	30	16
1X10	1.0	0.95	1.5	10.0	45.0	4.0	2	30	16
1X12	1.0	0.95	1.5	12.0	45.0	4.0	2	30	16
1X14	1.0	0.95	1.5	14.0	45.0	4.0	2	30	16
1X16	1.0	0.95	1.5	16.0	50.0	4.0	2	30	16
1X20	1.0	0.95	1.5	20.0	54.0	4.0	2	30	16
1X25	1.0	0.95	1.5	25.0	70.0	4.0	2	30	16
1X30	1.0	0.95	1.5	30.0	70.0	4.0	2	30	16
1,2X6	1.2	1.14	1.8	6.0	45.0	4.0	2	30	16
1,2X8	1.2	1.14	1.8	8.0	45.0	4.0	2	30	16
1,2X10	1.2	1.14	1.8	10.0	45.0	4.0	2	30	16
1,2X12	1.2	1.14	1.8	12.0	45.0	4.0	2	30	16
1,2X16	1.2	1.14	1.8	16.0	50.0	4.0	2	30	16
1,2X20	1.2	1.14	1.8	20.0	60.0	4.0	2	30	16
1,4X6	1.4	1.34	2.1	6.0	45.0	4.0	2	30	16
1,4X8	1.4	1.34	2.1	8.0	45.0	4.0	2	30	16
1,4X10	1.4	1.34	2.1	10.0	45.0	4.0	2	30	16
1,4X12	1.4	1.34	2.1	12.0	45.0	4.0	2	30	16
1,4X14	1.4	1.34	2.1	14.0	45.0	4.0	2	30	16
1,4X16	1.4	1.34	2.1	16.0	50.0	4.0	2	30	16
1,4X22	1.4	1.34	2.1	22.0	54.0	4.0	2	30	16
1,5X6	1.5	1.44	2.3	6.0	45.0	4.0	2	30	16
1,5X8	1.5	1.44	2.3	8.0	45.0	4.0	2	30	16
1,5X10	1.5	1.44	2.3	10.0	45.0	4.0	2	30	16
1,5X12	1.5	1.44	2.3	12.0	45.0	4.0	2	30	16
1,5X14	1.5	1.44	2.3	14.0	50.0	4.0	2	30	16
1,5X16	1.5	1.44	2.3	16.0	50.0	4.0	2	30	16

K201122	D1  mm ø	D3  mm ø	L2  mm	L3  mm	L1  mm	D2  mm ø	z  #	 °	α  °
1,5X18	1.5	1.44	2.3	18.0	54.0	4.0	2	30	16
1,5X20	1.5	1.44	2.3	20.0	54.0	4.0	2	30	16
1,5X25	1.5	1.44	2.3	25.0	70.0	4.0	2	30	16
1,5X30	1.5	1.44	2.3	30.0	70.0	4.0	2	30	16
1,5X35	1.5	1.44	2.3	35.0	70.0	4.0	2	30	16
1,5X40	1.5	1.44	2.3	40.0	80.0	4.0	2	30	16
1,5X45	1.5	1.44	2.3	45.0	80.0	4.0	2	30	16
1,6X6	1.6	1.51	2.4	6.0	45.0	4.0	2	30	16
1,6X8	1.6	1.51	2.4	8.0	45.0	4.0	2	30	16
1,6X10	1.6	1.51	2.4	10.0	45.0	4.0	2	30	16
1,6X12	1.6	1.51	2.4	12.0	45.0	4.0	2	30	16
1,6X14	1.6	1.51	2.4	14.0	50.0	4.0	2	30	16
1,6X16	1.6	1.51	2.4	16.0	50.0	4.0	2	30	16
1,6X18	1.6	1.51	2.4	18.0	54.0	4.0	2	30	16
1,6X20	1.6	1.51	2.4	20.0	54.0	4.0	2	30	16
1,6X26	1.6	1.51	2.4	26.0	60.0	4.0	2	30	16
1,8X6	1.8	1.71	2.7	6.0	45.0	4.0	2	30	16
1,8X8	1.8	1.71	2.7	8.0	45.0	4.0	2	30	16
1,8X10	1.8	1.71	2.7	10.0	45.0	4.0	2	30	16
1,8X12	1.8	1.71	2.7	12.0	45.0	4.0	2	30	16
1,8X14	1.8	1.71	2.7	14.0	50.0	4.0	2	30	16
1,8X16	1.8	1.71	2.7	16.0	50.0	4.0	2	30	16
1,8X18	1.8	1.71	2.7	18.0	54.0	4.0	2	30	16
1,8X20	1.8	1.71	2.7	20.0	54.0	4.0	2	30	16
1,8X25	1.8	1.71	2.7	25.0	60.0	4.0	2	30	16
2X6	2.0	1.91	3.0	6.0	45.0	4.0	2	30	16
2X8	2.0	1.91	3.0	8.0	45.0	4.0	2	30	16
2X10	2.0	1.91	3.0	10.0	45.0	4.0	2	30	16
2X12	2.0	1.91	3.0	12.0	45.0	4.0	2	30	16

K201122	D1	D3	L2	L3	L1	D2	z	°	α
	mm ∅	mm ∅	mm	mm	mm	mm ∅	#		
2X14	2.0	1.91	3.0	14.0	50.0	4.0	2	30	16
2X16	2.0	1.91	3.0	16.0	50.0	4.0	2	30	16
2X18	2.0	1.91	3.0	18.0	54.0	4.0	2	30	16
2X20	2.0	1.91	3.0	20.0	54.0	4.0	2	30	16
2X25	2.0	1.91	3.0	25.0	60.0	4.0	2	30	16
2X30	2.0	1.91	3.0	30.0	70.0	4.0	2	30	16
2X35	2.0	1.91	3.0	35.0	80.0	4.0	2	30	16
2X40	2.0	1.91	3.0	40.0	90.0	4.0	2	30	16
2X50	2.0	1.91	3.0	50.0	100.0	4.0	2	30	16
2X60	2.0	1.91	3.0	60.0	110.0	4.0	2	30	16
2,5X8	2.5	2.41	3.7	8.0	45.0	4.0	2	30	16
2,5X10	2.5	2.41	3.7	10.0	45.0	4.0	2	30	16
2,5X12	2.5	2.41	3.7	12.0	45.0	4.0	2	30	16
2,5X14	2.5	2.41	3.7	14.0	50.0	4.0	2	30	16
2,5X16	2.5	2.41	3.7	16.0	50.0	4.0	2	30	16
2,5X18	2.5	2.41	3.7	18.0	54.0	4.0	2	30	16
2,5X20	2.5	2.41	3.7	20.0	54.0	4.0	2	30	16
2,5X25	2.5	2.41	3.7	25.0	60.0	4.0	2	30	16
2,5X30	2.5	2.41	3.7	30.0	70.0	4.0	2	30	16
2,5X40	2.5	2.41	3.7	40.0	90.0	4.0	2	30	16
2,5X50	2.5	2.41	3.7	50.0	100.0	4.0	2	30	16
3X8	3.0	2.92	4.5	8.0	45.0	4.0	2	30	16
3X12	3.0	2.92	4.5	12.0	45.0	4.0	2	30	16
3X16	3.0	2.92	4.5	16.0	50.0	4.0	2	30	16
3X20	3.0	2.92	4.5	20.0	54.0	4.0	2	30	16

Dimension	∅0.2x0.5		∅0.2x1.5		∅0.3x1		∅0.3x9		∅0.4x2		∅0.4x12	
Infeed in mm	ae=1xD	ae=0.1xD	ae=1xD	ae=0.07xD	ae=1xD	ae=0.1xD	ae=1xD	ae=0.006xD	ae=1xD	ae=0.1xD	ae=1xD	ae=0.006xD
Application	ap=0.05xD	ap=L2 max	ap=0.04xD	ap=L2 max	ap=0.05xD	ap=L2 max	ap=0.003xD	ap=L2 max	ap=0.05xD	ap=L2 max	ap=0.003xD	ap=L2 max

Material	Hardness in HRC	Feed (mm/Z)	Vc (m/min)													
			fz	fz	fz	fz	fz	fz	fz	fz	fz	fz	fz	fz	fz	
H HARDENED STEEL																
1.1	46-55	110	0.005	0.009	0.005	0.009	0.008	0.012	0.003	0.005	0.008	0.012	0.003	0.005		
1.2	56-60	70	0.004	0.008	0.004	0.008	0.007	0.011	0.003	0.005	0.007	0.011	0.003	0.005		
1.3	60-65	50	0.003	0.008	0.003	0.008	0.006	0.01	0.002	0.002	0.006	0.01	0.002	0.002		
1.4	66-70	40	0.002	0.007	0.002	0.007	0.005	0.009	0.001	0.001	0.005	0.009	0.001	0.001		

Material	Strength (N/mm²)	Feed (mm/Z)	Vc (m/min)													
			fz	fz	fz	fz	fz	fz	fz	fz	fz	fz	fz	fz	fz	
M STAINLESS STEEL																
1.1	ferritic/martensitic <850	90	0.006	0.01	0.006	0.01	0.009	0.013	0.004	0.006	0.009	0.013	0.004	0.006		
2.1	austenitic <650	75	0.005	0.009	0.005	0.009	0.008	0.012	0.003	0.005	0.008	0.012	0.003	0.005		
2.2	austenitic <750	70	0.004	0.008	0.004	0.008	0.007	0.011	0.002	0.003	0.007	0.011	0.002	0.003		
3.1	DUPLEX STEEL super austenitic <1100	50	0.003	0.007	0.003	0.007	0.006	0.01	0.001	0.002	0.006	0.01	0.001	0.002		
N COPPER																
Tungsten Copper (WCu) <700		110	0.006	0.01	0.006	0.01	0.009	0.013	0.004	0.006	0.009	0.013	0.004	0.006		

Material	Strength (N/mm²)	Feed (mm/Z)	Vc (m/min)													
			fz	fz	fz	fz	fz	fz	fz	fz	fz	fz	fz	fz	fz	
P STEEL																
1.1	unalloyed <500	190	0.008	0.012	0.008	0.012	0.011	0.015	0.006	0.008	0.011	0.015	0.006	0.008		
1.2-1.5	unalloyed <1100	180	0.008	0.012	0.008	0.012	0.011	0.015	0.006	0.008	0.011	0.015	0.006	0.008		
2.1-2.2	low-alloyed <950	170	0.007	0.011	0.007	0.011	0.01	0.014	0.005	0.007	0.01	0.014	0.005	0.007		
2.3-2.4	low-alloyed <1300	150	0.007	0.011	0.007	0.011	0.01	0.014	0.005	0.007	0.01	0.014	0.005	0.007		
3.1-3.2	high-alloyed <1100	150	0.006	0.01	0.006	0.01	0.009	0.013	0.004	0.006	0.009	0.013	0.004	0.006		
3.3	high-alloyed <1400	130	0.005	0.009	0.005	0.009	0.008	0.012	0.003	0.005	0.008	0.012	0.003	0.005		

Material	Strength (N/mm²)	Feed (mm/Z)	Vc (m/min)													
			fz	fz	fz	fz	fz	fz	fz	fz	fz	fz	fz	fz	fz	
K CASTINGS																
1.1-1.2	Grey cast iron <1000	190	0.008	0.012	0.008	0.012	0.011	0.015	0.006	0.008	0.011	0.015	0.006	0.008		
2.1-2.2	Modular cast iron <850	180	0.007	0.011	0.007	0.011	0.01	0.014	0.005	0.007	0.01	0.014	0.005	0.007		
3.1-3.2	Malleable cast iron <800	170	0.007	0.011	0.007	0.011	0.01	0.014	0.005	0.007	0.01	0.014	0.005	0.007		

ADVICE | The values marked in turquoise are side applications! Values in the table are the shortest and the longest overhang length (L3) of each dimension; Please calculate fz, ap and ae depending on the given values.

Material	Hardness in HRC	Dimension	Ø 0.5x2		Ø 0.5x15		Ø 0.6x2		Ø 0.6x18		Ø 0.7x2		Ø 0.7x10		
			Infeed in mm		Infeed in mm		Infeed in mm		Infeed in mm		Infeed in mm		Infeed in mm		
			ae=	ae=	ae=	ae=	ae=	ae=	ae=	ae=	ae=	ae=	ae=	ae=	ae=
			1xD	0.1xD	1xD	0.006xD	1xD	0.1xD	1xD	0.006xD	1xD	0.1xD	1xD	0.05xD	
			ap=	ap=	ap=	ap=	ap=	ap=	ap=	ap=	ap=	ap=	ap=		
			0.05xD	L2 max	0.003xD	L2 max	0.05xD	L2 max	0.003xD	L2 max	0.05xD	L2 max	0.018xD	L2 max	
			Application		Application		Application		Application		Application		Application		
			Feed (mm/Z)	fz	fz	fz	fz	fz	fz	fz	fz	fz	fz	fz	
H	HARDENED STEEL		Vc (m/min)												
1.1	46-55	110	0.012	0.015	0.004	0.006	0.012	0.015	0.004	0.006	0.012	0.015	0.008	0.012	
1.2	56-60	70	0.011	0.014	0.004	0.006	0.011	0.014	0.004	0.006	0.011	0.014	0.007	0.011	
1.3	60-65	50	0.01	0.013	0.003	0.005	0.01	0.013	0.003	0.005	0.01	0.013	0.006	0.01	
1.4	66-70	40	0.009	0.012	0.002	0.004	0.009	0.012	0.002	0.004	0.009	0.012	0.005	0.009	

Material	Strength (N/mm²)	Feed (mm/Z)	Strength (N/mm²)												
			fz	fz	fz	fz	fz	fz	fz	fz	fz	fz	fz	fz	
M	STAINLESS STEEL		Vc (m/min)												
1.1	ferritic/martensitic	<850	90	0.013	0.016	0.005	0.006	0.013	0.016	0.005	0.007	0.013	0.016	0.009	0.013
2.1	austenitic	<650	75	0.012	0.015	0.004	0.005	0.012	0.015	0.004	0.006	0.012	0.015	0.008	0.012
2.2	austenitic	<750	70	0.011	0.014	0.003	0.004	0.011	0.014	0.003	0.005	0.011	0.014	0.007	0.011
3.1	DUPLEX STEEL super austenitic	<1100	50	0.01	0.013	0.002	0.003	0.01	0.013	0.002	0.004	0.01	0.013	0.006	0.01

Material	Strength (N/mm²)	Feed (mm/Z)	Strength (N/mm²)												
			fz	fz	fz	fz	fz	fz	fz	fz	fz	fz	fz	fz	
N	COPPER		Vc (m/min)												
	Tungsten Copper (WCu)	<700	110	0.013	0.016	0.005	0.006	0.013	0.016	0.005	0.007	0.013	0.016	0.009	0.013

Material	Strength (N/mm²)	Feed (mm/Z)	Strength (N/mm²)												
			fz	fz	fz	fz	fz	fz	fz	fz	fz	fz	fz	fz	
P	STEEL		Vc (m/min)												
1.1	unalloyed	<500	190	0.015	0.02	0.007	0.009	0.015	0.02	0.007	0.009	0.015	0.02	0.011	0.017
1.2-1.5	unalloyed	<1100	180	0.015	0.02	0.007	0.009	0.015	0.02	0.007	0.009	0.015	0.02	0.011	0.017
2.1-2.2	low-alloyed	<950	170	0.014	0.018	0.006	0.008	0.014	0.018	0.006	0.008	0.014	0.018	0.01	0.015
2.3-2.4	low-alloyed	<1300	150	0.014	0.018	0.006	0.008	0.014	0.018	0.006	0.008	0.014	0.018	0.01	0.015
3.1-3.2	high-alloyed	<1100	150	0.013	0.016	0.005	0.007	0.013	0.016	0.005	0.007	0.013	0.016	0.009	0.013
3.3	high-alloyed	<1400	130	0.012	0.015	0.004	0.006	0.012	0.015	0.004	0.006	0.012	0.015	0.008	0.012

Material	Strength (N/mm²)	Feed (mm/Z)	Strength (N/mm²)												
			fz	fz	fz	fz	fz	fz	fz	fz	fz	fz	fz	fz	
K	CASTINGS		Vc (m/min)												
1.1-1.2	Grey cast iron	<1000	190	0.015	0.02	0.007	0.009	0.015	0.02	0.007	0.009	0.015	0.02	0.011	0.017
2.1-2.2	Modular cast iron	<850	180	0.014	0.018	0.006	0.008	0.014	0.018	0.006	0.008	0.014	0.018	0.01	0.015
3.1-3.2	Malleable cast iron	<800	170	0.014	0.018	0.006	0.008	0.014	0.018	0.006	0.008	0.014	0.018	0.01	0.015

ADVICE | The values marked in turquoise are side applications! Values in the table are the shortest and the longest overhang length (L3) of each dimension; Please calculate fz, ap and ae depending on the given values.

Material	Hardness in HRC	Dimension	Ø 0.8x4		Ø 0.8x24		Ø 0.9x4		Ø 0.9x15	
			Infeed in mm		Infeed in mm		Infeed in mm		Infeed in mm	
			ae=	ae=	ae=	ae=	ae=	ae=	ae=	ae=
			1xD	0.1xD	1xD	0.006xD	1xD	0.1xD	1xD	0.015xD
			ap=	ap=	ap=	ap=	ap=	ap=	ap=	ap=
			0.05xD	L2 max	0.003xD	L2 max	0.05xD	L2 max	0.008xD	L2 max
			Application		Application		Application		Application	
			Feed (mm/Z)	fz	fz	fz	fz	fz	fz	fz
H	HARDENED STEEL		Vc (m/min)							
1.1	46-55	110	0.014	0.017	0.006	0.01	0.014	0.017	0.01	0.012
1.2	56-60	70	0.013	0.016	0.005	0.009	0.013	0.016	0.009	0.011
1.3	60-65	50	0.012	0.015	0.004	0.008	0.012	0.015	0.008	0.01
1.4	66-70	40	0.011	0.014	0.003	0.007	0.011	0.014	0.007	0.009

Material	Strength (N/mm²)	Feed (mm/Z)	Strength (N/mm²)								
			fz	fz	fz	fz	fz	fz	fz	fz	
M	STAINLESS STEEL		Vc (m/min)								
1.1	ferritic/martensitic	<850	90	0.015	0.018	0.007	0.011	0.015	0.018	0.011	0.013
2.1	austenitic	<650	75	0.014	0.017	0.006	0.01	0.014	0.017	0.01	0.012
2.2	austenitic	<750	70	0.013	0.016	0.005	0.009	0.013	0.016	0.009	0.011
3.1	DUPLEX STEEL super austenitic	<1100	50	0.012	0.015	0.004	0.008	0.012	0.015	0.008	0.01

Material	Strength (N/mm²)	Feed (mm/Z)	Strength (N/mm²)								
			fz	fz	fz	fz	fz	fz	fz	fz	
N	COPPER		Vc (m/min)								
	Tungsten Copper (WCu)	<700	110	0.015	0.018	0.007	0.011	0.015	0.018	0.011	0.013

Material	Strength (N/mm²)	Feed (mm/Z)	Strength (N/mm²)								
			fz	fz	fz	fz	fz	fz	fz	fz	
P	STEEL		Vc (m/min)								
1.1	unalloyed	<500	190	0.017	0.022	0.009	0.014	0.017	0.022	0.013	0.016
1.2-1.5	unalloyed	<1100	180	0.017	0.022	0.009	0.014	0.017	0.022	0.013	0.016
2.1-2.2	low-alloyed	<950	170	0.016	0.02	0.008	0.013	0.016	0.02	0.012	0.015
2.3-2.4	low-alloyed	<1300	150	0.016	0.02	0.008	0.013	0.016	0.02	0.012	0.015
3.1-3.2	high-alloyed	<1100	150	0.015	0.018	0.007	0.011	0.015	0.018	0.011	0.013
3.3	high-alloyed	<1400	130	0.014	0.017	0.006	0.01	0.014	0.017	0.01	0.012

Material	Strength (N/mm²)	Feed (mm/Z)	Strength (N/mm²)								
			fz	fz	fz	fz	fz	fz	fz	fz	
K	CASTINGS		Vc (m/min)								
1.1-1.2	Grey cast iron	<1000	190	0.017	0.022	0.009	0.014	0.017	0.022	0.013	0.016
2.1-2.2	Modular cast iron	<850	180	0.016	0.02	0.008	0.013	0.016	0.02	0.012	0.015
3.1-3.2	Malleable cast iron	<800	170	0.016	0.02	0.008	0.013	0.016	0.02	0.012	0.015

ADVICE | The values marked in turquoise are side applications! Values in the table are the shortest and the longest overhang length (L3) of each dimension; Please calculate fz, ap and ae depending on the given values.

Material	Hardness in HRC	Dimension	Ø1x4		Ø1x30		Ø1.2x6		Ø1.2x20		Ø1.4x6		Ø1.4x22	
			Infeed in mm	Application	ae=1xD	ae=0.1xD	ae=1xD	ae=0.006xD	ae=1xD	ae=0.1xD	ae=1xD	ae=0.015xD	ae=1xD	ae=0.1xD
			ap=0.05xD	ap=L2 max	ap=0.003xD	ap=L2 max	ap=0.05xD	ap=L2 max	ap=0.008xD	ap=L2 max	ap=0.05xD	ap=L2 max	ap=0.008xD	ap=L2 max
Feed (mm/Z)			fz	fz	fz	fz	fz	fz	fz	fz	fz	fz	fz	
Vc (m/min)														
H	HARDENED STEEL													
1.1	46-55	110	0.015	0.02	0.006	0.01	0.015	0.02	0.01	0.015	0.017	0.022	0.012	0.017
1.2	56-60	70	0.014	0.019	0.005	0.009	0.014	0.019	0.009	0.014	0.016	0.021	0.011	0.016
1.3	60-65	50	0.012	0.017	0.004	0.008	0.012	0.017	0.007	0.012	0.014	0.019	0.009	0.014
1.4	66-70	40	0.011	0.016	0.003	0.007	0.011	0.016	0.006	0.011	0.012	0.018	0.008	0.013

Material	Strength (N/mm ²)	Feed (mm/Z)	fz												
			Vc (m/min)												
M	STAINLESS STEEL														
1.1	ferritic/martensitic	<850	90	0.016	0.021	0.007	0.011	0.016	0.021	0.011	0.016	0.018	0.023	0.013	0.018
2.1	austenitic	<650	75	0.015	0.02	0.006	0.01	0.015	0.02	0.01	0.015	0.017	0.022	0.012	0.017
2.2	austenitic	<750	70	0.013	0.018	0.005	0.009	0.013	0.018	0.008	0.013	0.015	0.02	0.01	0.015
3.1	DUPLEX STEEL super austenitic	<1100	50	0.012	0.017	0.004	0.008	0.012	0.017	0.007	0.012	0.014	0.019	0.009	0.014
N	COPPER														
	Tungsten Copper (WCu)	<700	110	0.016	0.021	0.007	0.011	0.016	0.021	0.011	0.016	0.018	0.023	0.013	0.018

Material	Strength (N/mm ²)	Feed (mm/Z)	fz												
			Vc (m/min)												
P	STEEL														
1.1	unalloyed	<500	190	0.018	0.025	0.009	0.013	0.019	0.025	0.013	0.018	0.021	0.027	0.015	0.021
1.2-1.5	unalloyed	<1100	180	0.018	0.025	0.009	0.013	0.019	0.025	0.013	0.018	0.021	0.027	0.015	0.021
2.1-2.2	low-alloyed	<950	170	0.017	0.023	0.008	0.012	0.018	0.023	0.012	0.017	0.02	0.025	0.014	0.02
2.3-2.4	low-alloyed	<1300	150	0.017	0.023	0.008	0.012	0.018	0.023	0.012	0.017	0.02	0.025	0.014	0.02
3.1-3.2	high-alloyed	<1100	150	0.016	0.021	0.007	0.011	0.016	0.021	0.011	0.016	0.018	0.023	0.013	0.018
3.3	high-alloyed	<1400	130	0.015	0.02	0.006	0.01	0.015	0.02	0.01	0.015	0.017	0.022	0.012	0.017

Material	Strength (N/mm ²)	Feed (mm/Z)	fz												
			Vc (m/min)												
K	CASTINGS														
1.1-1.2	Grey cast iron	<1000	190	0.018	0.025	0.009	0.013	0.019	0.025	0.013	0.018	0.021	0.027	0.015	0.021
2.1-2.2	Modular cast iron	<850	180	0.017	0.023	0.008	0.012	0.018	0.023	0.012	0.017	0.02	0.025	0.014	0.02
3.1-3.2	Malleable cast iron	<800	170	0.017	0.023	0.008	0.012	0.018	0.023	0.012	0.017	0.02	0.025	0.014	0.02

ADVICE | The values marked in turquoise are side applications! Values in the table are the shortest and the longest overhang length (L3) of each dimension; Please calculate fz, ap and ae depending on the given values.

Material	Hardness in HRC	Dimension	Ø1.5x6		Ø1.5x45		Ø1.6x6		Ø1.6x26		Ø1.8x6		Ø1.8x25	
			Infeed in mm	Application	ae=1xD	ae=0.1xD	ae=1xD	ae=0.006xD	ae=1xD	ae=0.1xD	ae=1xD	ae=0.02xD	ae=1xD	ae=0.1xD
			ap=0.05xD	ap=L2 max	ap=0.003xD	ap=L2 max	ap=0.05xD	ap=L2 max	ap=0.01xD	ap=L2 max	ap=0.05xD	ap=L2 max	ap=0.018xD	ap=L2 max
Feed (mm/Z)			fz	fz	fz	fz	fz	fz	fz	fz	fz	fz	fz	
Vc (m/min)														
H	HARDENED STEEL													
1.1	46-55	110	0.02	0.025	0.011	0.016	0.025	0.03	0.018	0.023	0.025	0.03	0.018	0.023
1.2	56-60	70	0.019	0.024	0.01	0.015	0.023	0.028	0.016	0.021	0.023	0.028	0.016	0.021
1.3	60-65	50	0.017	0.022	0.008	0.013	0.021	0.026	0.014	0.019	0.021	0.026	0.014	0.019
1.4	66-70	40	0.016	0.021	0.007	0.012	0.019	0.025	0.012	0.017	0.019	0.025	0.012	0.017

Material	Strength (N/mm ²)	Feed (mm/Z)	fz												
			Vc (m/min)												
M	STAINLESS STEEL														
1.1	ferritic/martensitic	<850	90	0.021	0.026	0.012	0.017	0.026	0.031	0.019	0.024	0.026	0.031	0.019	0.024
2.1	austenitic	<650	75	0.02	0.025	0.011	0.016	0.024	0.029	0.017	0.022	0.024	0.029	0.017	0.022
2.2	austenitic	<750	70	0.018	0.023	0.009	0.014	0.022	0.027	0.015	0.02	0.022	0.027	0.015	0.02
3.1	DUPLEX STEEL super austenitic	<1100	50	0.017	0.022	0.008	0.013	0.02	0.026	0.013	0.018	0.02	0.025	0.013	0.018
N	COPPER														
	Tungsten Copper (WCu)	<700	110	0.021	0.026	0.012	0.017	0.026	0.031	0.019	0.024	0.026	0.031	0.019	0.024

Material	Strength (N/mm ²)	Feed (mm/Z)	fz												
			Vc (m/min)												
P	STEEL														
1.1	unalloyed	<500	190	0.025	0.03	0.014	0.019	0.03	0.037	0.021	0.027	0.03	0.037	0.022	0.028
1.2-1.5	unalloyed	<1100	180	0.025	0.03	0.014	0.019	0.03	0.037	0.021	0.027	0.03	0.037	0.022	0.028
2.1-2.2	low-alloyed	<950	170	0.023	0.028	0.013	0.018	0.028	0.035	0.02	0.026	0.028	0.035	0.02	0.026
2.3-2.4	low-alloyed	<1300	150	0.023	0.028	0.013	0.018	0.028	0.035	0.02	0.026	0.028	0.035	0.02	0.026
3.1-3.2	high-alloyed	<1100	150	0.021	0.026	0.12	0.017	0.026	0.032	0.019	0.024	0.026	0.032	0.019	0.024
3.3	high-alloyed	<1400	130	0.02	0.025	0.011	0.016	0.025	0.03	0.018	0.023	0.025	0.03	0.018	0.023

Material	Strength (N/mm ²)	Feed (mm/Z)	fz												
			Vc (m/min)												
K	CASTINGS														
1.1-1.2	Grey cast iron	<1000	190	0.025	0.03	0.014	0.019	0.03	0.037	0.021	0.027	0.03	0.037	0.022	0.028
2.1-2.2	Modular cast iron	<850	180	0.023	0.028	0.013	0.018	0.028	0.035	0.02	0.026	0.028	0.035	0.02	0.026
3.1-3.2	Malleable cast iron	<800	170	0.023	0.028	0.013	0.018	0.028	0.035	0.02	0.026	0.028	0.035	0.02	0.026

ADVICE | The values marked in turquoise are side applications! Values in the table are the shortest and the longest overhang length (L3) of each dimension; Please calculate fz, ap and ae depending on the given values.

Material	Hardness in HRC	Dimension	Ø2x6		Ø2x60		Ø2.5x8		Ø2.5x50		Ø3x8		Ø3x20			
			Infeed in mm	ap=	ap=	ap=	ap=	ap=	ap=	ap=	ap=	ap=	ap=			
H HARDENED STEEL	Vc (m/min)	1.1	46-55	110	0.025	0.03	0.015	0.025	0.027	0.032	0.015	0.025	0.027	0.032	0.025	0.03
		1.2	56-60	70	0.023	0.028	0.013	0.023	0.025	0.03	0.013	0.023	0.025	0.03	0.023	0.028
		1.3	60-65	50	0.021	0.026	0.011	0.021	0.023	0.028	0.011	0.021	0.023	0.028	0.021	0.026
		1.4	66-70	40	0.019	0.025	0.009	0.019	0.021	0.026	0.009	0.019	0.021	0.026	0.019	0.024

Material	Strength (N/mm²)	Feed (mm/Z)	fz		fz		fz		fz		fz		fz				
			Vc (m/min)	fz	fz	fz	fz	fz	fz	fz	fz	fz					
M STAINLESS STEEL	Vc (m/min)	1.1	ferritic/martensitic	<850	90	0.026	0.031	0.016	0.026	0.028	0.033	0.016	0.026	0.028	0.033	0.026	0.032
		2.1	austenitic	<650	75	0.024	0.029	0.014	0.024	0.026	0.031	0.014	0.024	0.026	0.031	0.024	0.03
		2.2	austenitic	<750	70	0.022	0.027	0.012	0.022	0.024	0.029	0.012	0.022	0.024	0.029	0.022	0.028
		3.1	DUPLEX STEEL super austenitic	<1100	50	0.02	0.025	0.01	0.02	0.02	0.027	0.01	0.02	0.022	0.027	0.02	0.026

Material	Strength (N/mm²)	Feed (mm/Z)	fz		fz		fz		fz		fz		fz		
			Vc (m/min)	fz	fz	fz	fz	fz	fz	fz	fz	fz			
N COPPER	Tungsten Copper (WCu)	<700	110	0.026	0.031	0.016	0.026	0.028	0.033	0.016	0.026	0.028	0.033	0.026	0.032

Material	Strength (N/mm²)	Feed (mm/Z)	fz		fz		fz		fz		fz		fz				
			Vc (m/min)	fz	fz	fz	fz	fz	fz	fz	fz	fz					
P STEEL	Vc (m/min)	1.1	unalloyed	<500	190	0.03	0.037	0.018	0.028	0.032	0.039	0.018	0.03	0.032	0.04	0.03	0.037
		1.2-1.5	unalloyed	<1100	180	0.03	0.037	0.018	0.028	0.032	0.039	0.018	0.03	0.032	0.04	0.03	0.037
		2.1-2.2	low-alloyed	<950	170	0.028	0.035	0.017	0.027	0.03	0.037	0.017	0.028	0.03	0.037	0.028	0.035
		2.3-2.4	low-alloyed	<1300	150	0.028	0.035	0.017	0.027	0.03	0.037	0.017	0.028	0.03	0.037	0.028	0.035
		3.1-3.2	high-alloyed	<1100	150	0.026	0.032	0.016	0.026	0.028	0.034	0.016	0.026	0.028	0.034	0.026	0.032
		3.3	high-alloyed	<1400	130	0.025	0.03	0.015	0.025	0.027	0.032	0.015	0.025	0.027	0.032	0.025	0.03

Material	Strength (N/mm²)	Feed (mm/Z)	fz		fz		fz		fz		fz		fz				
			Vc (m/min)	fz	fz	fz	fz	fz	fz	fz	fz	fz					
K CASTINGS	Vc (m/min)	1.1-1.2	Grey cast iron	<1000	190	0.03	0.037	0.018	0.028	0.032	0.039	0.018	0.03	0.032	0.04	0.03	0.037
		2.1-2.2	Modular cast iron	<850	180	0.028	0.035	0.017	0.027	0.03	0.037	0.017	0.028	0.03	0.037	0.028	0.035
		3.1-3.2	Malleable cast iron	<800	170	0.028	0.035	0.017	0.027	0.03	0.037	0.017	0.028	0.03	0.037	0.028	0.035

ADVICE | The values marked in turquoise are side applications!
 Values in the table are the shortest and the longest overhang length (L3) of each dimension;
 Please calculate fz, ap and ae depending on the given values.

DO YOU HAVE BLUNT MILLING CUTTERS THAT URGENTLY NEED REGRINDING?



DISCOVER OUR H&V REGRINDING SERVICE

... and have your tools reconditioned to their original state!



Cooling	
Tolerance	d04
Coating	AlphaDura Navy

Strategy	HSC	HPC	
Application			
Features	HA		

- Ultrafine carbide grade developed for machining hardened steels
 - Optimized face geometry for long tool life and highest dimensional accuracy
 - Reinforced core for milling up to 70 HRC
-
- Multipass milling of 3D contours
-
- Tolerance D1: -0.001/-0.006 mm
 - Tolerance D3: 0/-0.02 mm
 - Radius tolerance r: 0/-0.003 mm (measured from 0-90°)

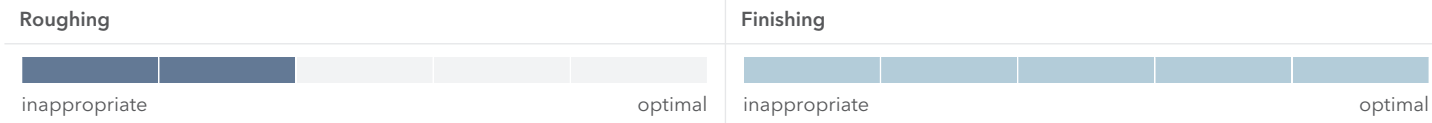
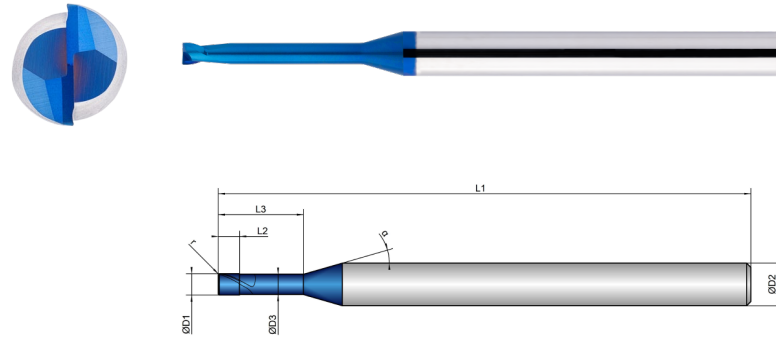

K202082	D1 mm ∅	D3 mm ∅	L2 mm	L3 mm	L1 mm	D2 mm ∅	z #	r mm		α °
0,4X1	0.4	0.38	0.4	1.0	50.0	4.0	2	0.10	30	16
0,4X1,5	0.4	0.38	0.4	1.5	50.0	4.0	2	0.10	30	16
0,4X2	0.4	0.38	0.4	2.0	50.0	4.0	2	0.10	30	16
0,4X3	0.4	0.38	0.4	3.0	50.0	4.0	2	0.10	30	16
0,4X4	0.4	0.38	0.4	4.0	50.0	4.0	2	0.10	30	16
0,5X1	0.5	0.48	0.5	1.0	50.0	4.0	2	0.10	30	16
0,5X2	0.5	0.48	0.5	2.0	50.0	4.0	2	0.10	30	16
0,5X3	0.5	0.48	0.5	3.0	50.0	4.0	2	0.10	30	16
0,5X4	0.5	0.48	0.5	4.0	50.0	4.0	2	0.10	30	16
0,5X5	0.5	0.48	0.5	5.0	50.0	4.0	2	0.10	30	16
0,5X6	0.5	0.48	0.5	6.0	50.0	4.0	2	0.10	30	16
0,6X2	0.6	0.58	0.6	2.0	50.0	4.0	2	0.10	30	16

K202082	D1 mm ∅	D3 mm ∅	L2 mm	L3 mm	L1 mm	D2 mm ∅	z #	r mm		α °
0,6X3	0.6	0.58	0.6	3.0	50.0	4.0	2	0.10	30	16
0,6X4	0.6	0.58	0.6	4.0	50.0	4.0	2	0.10	30	16
0,6X6	0.6	0.58	0.6	6.0	50.0	4.0	2	0.10	30	16
0,6X8	0.6	0.58	0.6	8.0	50.0	4.0	2	0.10	30	16
0,7X4	0.7	0.68	0.7	4.0	50.0	4.0	2	0.10	30	16
0,7X6	0.7	0.68	0.7	6.0	50.0	4.0	2	0.10	30	16
0,8X4	0.8	0.78	0.8	4.0	50.0	4.0	2	0.10	30	16
0,8X6	0.8	0.78	0.8	6.0	50.0	4.0	2	0.10	30	16
1X2	1.0	0.95	1.0	2.0	50.0	4.0	2	0.10	30	16
1X4	1.0	0.95	1.0	4.0	50.0	4.0	2	0.10	30	16
1X6	1.0	0.95	1.0	6.0	50.0	4.0	2	0.10	30	16
1X8	1.0	0.95	1.0	8.0	50.0	4.0	2	0.10	30	16
1X10	1.0	0.95	1.0	10.0	50.0	4.0	2	0.10	30	16
1X12	1.0	0.95	1.0	12.0	54.0	4.0	2	0.10	30	16
1X16	1.0	0.95	1.0	16.0	60.0	4.0	2	0.10	30	16
1X20	1.0	0.95	1.0	20.0	60.0	4.0	2	0.10	30	16
2X4	2.0	1.91	2.0	4.0	50.0	4.0	2	0.10	30	16
2X6	2.0	1.91	2.0	6.0	50.0	4.0	2	0.10	30	16
2X8	2.0	1.91	2.0	8.0	50.0	4.0	2	0.10	30	16
2X10	2.0	1.91	2.0	10.0	50.0	4.0	2	0.10	30	16
2X12	2.0	1.91	2.0	12.0	54.0	4.0	2	0.10	30	16
2X16	2.0	1.91	2.0	16.0	54.0	4.0	2	0.10	30	16
2X20	2.0	1.91	2.0	20.0	60.0	4.0	2	0.10	30	16
2X26	2.0	1.91	2.0	26.0	70.0	4.0	2	0.10	30	16

Material	Hardness in HRC	Dimension	Infeed in mm	Ø0.4x1			Ø0.4x4			Ø0.5x1			Ø0.5x6		
				ae=1xD	ae=0.1xD	ae=0.1xD	ae=1xD	ae=0.06xD	ae=0.05xD	ae=1xD	ae=0.1xD	ae=0.1xD	ae=1xD	ae=0.04xD	ae=0.04xD
		Feed (mm/Z)	fz	fz	fz	fz	fz	fz	fz	fz	fz	fz	fz	fz	
		Vc (m/min)													
H	HARDENED STEEL														
1.1	46-55	110	0.008	0.012	0.014	0.004	0.009	0.011	0.012	0.015	0.017	0.009	0.012	0.014	
1.2	56-60	70	0.007	0.011	0.013	0.004	0.008	0.01	0.011	0.014	0.016	0.008	0.011	0.013	
1.3	60-65	50	0.006	0.01	0.012	0.003	0.007	0.009	0.01	0.013	0.015	0.007	0.01	0.012	
1.4	66-70	40	0.005	0.009	0.011	0.002	0.006	0.008	0.009	0.012	0.014	0.006	0.009	0.011	

Material	Strength (N/mm ²)	Feed (mm/Z)	fz												
			fz	fz	fz	fz	fz	fz	fz	fz	fz	fz	fz	fz	
M	STAINLESS STEEL														
		Vc (m/min)													
1.1	ferritic/martensitic	<850	90	0.009	0.013	0.015	0.005	0.01	0.012	0.013	0.016	0.018	0.01	0.013	0.015
2.1	austenitic	<650	75	0.008	0.012	0.014	0.004	0.009	0.011	0.012	0.015	0.017	0.009	0.012	0.014
2.2	austenitic	<750	70	0.007	0.011	0.013	0.003	0.008	0.01	0.011	0.014	0.016	0.008	0.011	0.013
3.1	DUPLEX STEEL super austenitic	<1100	50	0.006	0.01	0.012	0.002	0.007	0.009	0.01	0.013	0.015	0.007	0.01	0.012

Material	Hardness in HRC	Dimension	Infeed in mm	Ø0.6x2			Ø0.6x8			Ø0.7x6			Ø0.8x6		
				ae=1xD	ae=0.1xD	ae=0.1xD	ae=1xD	ae=0.04xD	ae=0.04xD	ae=1xD	ae=0.1xD	ae=0.1xD	ae=1xD	ae=0.1xD	ae=0.1xD
		Feed (mm/Z)	fz	fz	fz	fz	fz	fz	fz	fz	fz	fz	fz	fz	
		Vc (m/min)													
H	HARDENED STEEL														
1.1	46-55	110	0.012	0.015	0.017	0.009	0.012	0.014	0.012	0.015	0.017	0.014	0.017	0.019	
1.2	56-60	70	0.011	0.014	0.016	0.008	0.011	0.013	0.011	0.014	0.016	0.013	0.016	0.018	
1.3	60-65	50	0.01	0.013	0.015	0.007	0.01	0.012	0.01	0.013	0.015	0.012	0.015	0.017	
1.4	66-70	40	0.009	0.012	0.014	0.006	0.009	0.011	0.009	0.012	0.014	0.011	0.014	0.016	

Material	Strength (N/mm ²)	Feed (mm/Z)	fz												
			fz	fz	fz	fz	fz	fz	fz	fz	fz	fz	fz	fz	
M	STAINLESS STEEL														
		Vc (m/min)													
1.1	ferritic/martensitic	<850	90	0.013	0.016	0.018	0.01	0.013	0.015	0.013	0.016	0.018	0.015	0.018	0.02
2.1	austenitic	<650	75	0.012	0.015	0.017	0.009	0.012	0.014	0.012	0.015	0.017	0.014	0.017	0.019
2.2	austenitic	<750	70	0.011	0.014	0.016	0.008	0.011	0.013	0.011	0.014	0.016	0.013	0.016	0.018
3.1	DUPLEX STEEL super austenitic	<1100	50	0.01	0.013	0.015	0.007	0.01	0.012	0.01	0.013	0.015	0.012	0.015	0.017

Material	Hardness in HRC	Dimension	Infeed in mm	Ø0.6x2			Ø0.6x8			Ø0.7x6			Ø0.8x6		
				ae=1xD	ae=0.1xD	ae=0.1xD	ae=1xD	ae=0.04xD	ae=0.04xD	ae=1xD	ae=0.1xD	ae=0.1xD	ae=1xD	ae=0.1xD	ae=0.1xD
		Feed (mm/Z)	fz	fz	fz	fz	fz	fz	fz	fz	fz	fz	fz	fz	
		Vc (m/min)													
N	COPPER														
		Vc (m/min)													
	Tungsten Copper (WCu) <700	110	0.013	0.016	0.018	0.01	0.013	0.015	0.013	0.016	0.018	0.015	0.018	0.02	

Material	Strength (N/mm ²)	Feed (mm/Z)	fz												
			fz	fz	fz	fz	fz	fz	fz	fz	fz	fz	fz	fz	
P	STEEL														
		Vc (m/min)													
1.1	unalloyed	<500	190	0.015	0.02	0.022	0.012	0.017	0.019	0.015	0.02	0.022	0.017	0.022	0.024
1.2-1.5	unalloyed	<1100	180	0.015	0.02	0.022	0.012	0.017	0.019	0.015	0.02	0.022	0.017	0.022	0.024
2.1-2.2	low-alloyed	<950	170	0.014	0.018	0.02	0.011	0.015	0.017	0.014	0.018	0.02	0.016	0.02	0.022
2.3-2.4	low-alloyed	<1300	150	0.014	0.018	0.02	0.011	0.015	0.017	0.014	0.018	0.02	0.016	0.02	0.022
3.1-3.2	high-alloyed	<1100	150	0.013	0.016	0.018	0.01	0.013	0.015	0.013	0.016	0.018	0.015	0.018	0.02
3.3	high-alloyed	<1400	130	0.012	0.015	0.017	0.009	0.012	0.014	0.012	0.015	0.017	0.014	0.017	0.019

Material	Hardness in HRC	Dimension	Infeed in mm	Ø0.6x2			Ø0.6x8			Ø0.7x6			Ø0.8x6		
				ae=1xD	ae=0.1xD	ae=0.1xD	ae=1xD	ae=0.04xD	ae=0.04xD	ae=1xD	ae=0.1xD	ae=0.1xD	ae=1xD	ae=0.1xD	ae=0.1xD
		Feed (mm/Z)	fz	fz	fz	fz	fz	fz	fz	fz	fz	fz	fz	fz	
		Vc (m/min)													
K	CASTINGS														
		Vc (m/min)													
1.1-1.2	Grey cast iron	<1000	190	0.011	0.015	0.017	0.007	0.012	0.014	0.015	0.02	0.022	0.012	0.017	0.019
2.1-2.2	Modular cast iron	<850	180	0.01	0.014	0.016	0.006	0.011	0.013	0.014	0.018	0.02	0.011	0.015	0.017
3.1-3.2	Malleable cast iron	<800	170	0.01	0.014	0.015	0.006	0.011	0.013	0.014	0.018	0.02	0.011	0.015	0.017

Material	Strength (N/mm ²)	Feed (mm/Z)	fz												
			fz	fz	fz	fz	fz	fz	fz	fz	fz	fz	fz	fz	
K	CASTINGS														
		Vc (m/min)													
1.1-1.2	Grey cast iron	<1000	190	0.015	0.02	0.022	0.012	0.017	0.019	0.015	0.02	0.022	0.017	0.022	0.024
2.1-2.2	Modular cast iron	<850	180	0.014	0.018	0.02	0.011	0.015	0.017	0.014	0.018	0.02	0.016	0.02	0.022
3.1-3.2	Malleable cast iron	<800	170	0.014	0.018	0.02	0.011	0.015	0.017	0.014	0.018	0.02	0.016	0.02	0.022

ADVICE | The values marked in turquoise are side applications!
 Values in the table are the shortest and the longest overhang length (L3) of each dimension;
 Please calculate fz, ap and ae depending on the given values.  ae/ap(max) = 0.5x corner radius!

ADVICE | The values marked in turquoise are side applications!
 Values in the table are the shortest and the longest overhang length (L3) of each dimension;
 Please calculate fz, ap and ae depending on the given values.  ae/ap(max) = 0.5x corner radius!

Material	Hardness in HRC	Dimension	Ø1x2			Ø1x20			Ø2x4			Ø2x26		
			ae=1xD	ae=0.1xD	ae=0.1xD	ae=1xD	ae=0.01xD	ae=0.01xD	ae=1xD	ae=0.1xD	ae=0.1xD	ae=1xD	ae=0.06xD	ae=0.05xD
		Infeed in mm	ap=0.05xD	ap=L2 max	ap=0.1xD	ap=0.005xD	ap=L2 max	ap=0.01xD	ap=0.05xD	ap=L2 max	ap=0.1xD	ap=0.03xD	ap=L2 max	ap=0.05xD
		Application												
		Feed (mm/Z)	fz	fz	fz	fz	fz	fz	fz	fz	fz	fz	fz	fz
H	HARDENED STEEL	Vc (m/min)												
1.1	46-55	110	0.015	0.02	0.022	0.007	0.01	0.012	0.025	0.03	0.032	0.02	0.025	0.027
1.2	56-60	70	0.014	0.019	0.021	0.006	0.009	0.011	0.023	0.028	0.03	0.019	0.024	0.026
1.3	60-65	50	0.012	0.017	0.019	0.005	0.008	0.01	0.021	0.026	0.028	0.018	0.023	0.025
1.4	66-70	40	0.011	0.016	0.018	0.004	0.007	0.009	0.019	0.025	0.027	0.017	0.022	0.024

Material	Strength (N/mm²)	Feed (mm/Z)	Strength												
			fz	fz	fz	fz	fz	fz	fz	fz	fz	fz	fz	fz	
M	STAINLESS STEEL	Vc (m/min)													
1.1	ferritic/martensitic	<850	90	0.016	0.021	0.023	0.006	0.011	0.013	0.026	0.031	0.033	0.021	0.026	0.028
2.1	austenitic	<650	75	0.015	0.02	0.022	0.005	0.01	0.012	0.024	0.029	0.031	0.019	0.025	0.027
2.2	austenitic	<750	70	0.013	0.018	0.02	0.004	0.008	0.01	0.022	0.027	0.029	0.017	0.024	0.026
3.1	DUPLEX STEEL super austenitic	<1100	50	0.012	0.017	0.019	0.003	0.007	0.009	0.02	0.025	0.027	0.015	0.023	0.025

Material	Hardness in HRC	Feed (mm/Z)	Strength												
			fz	fz	fz	fz	fz	fz	fz	fz	fz	fz	fz	fz	
N	COPPER	Vc (m/min)													
	Tungsten Copper (WCu)	<700	110	0.016	0.021	0.023	0.006	0.011	0.013	0.026	0.031	0.033	0.021	0.026	0.028

Material	Hardness in HRC	Feed (mm/Z)	Strength												
			fz	fz	fz	fz	fz	fz	fz	fz	fz	fz	fz	fz	
P	STEEL	Vc (m/min)													
1.1	unalloyed	<500	190	0.018	0.025	0.027	0.008	0.015	0.017	0.03	0.037	0.039	0.025	0.032	0.034
1.2-1.5	unalloyed	<1100	180	0.018	0.025	0.027	0.008	0.015	0.017	0.03	0.037	0.039	0.025	0.032	0.034
2.1-2.2	low-alloyed	<950	170	0.017	0.023	0.024	0.007	0.013	0.015	0.028	0.035	0.037	0.023	0.03	0.032
2.3-2.4	low-alloyed	<1300	150	0.017	0.023	0.024	0.007	0.013	0.015	0.028	0.035	0.037	0.023	0.03	0.032
3.1-3.2	high-alloyed	<1100	150	0.016	0.021	0.023	0.006	0.011	0.013	0.026	0.032	0.034	0.021	0.027	0.029
3.3	high-alloyed	<1400	130	0.015	0.02	0.022	0.005	0.01	0.012	0.025	0.03	0.032	0.02	0.025	0.027

Material	Hardness in HRC	Feed (mm/Z)	Strength												
			fz	fz	fz	fz	fz	fz	fz	fz	fz	fz	fz	fz	
K	CASTINGS	Vc (m/min)													
1.1-1.2	Grey cast iron	<1000	190	0.018	0.025	0.027	0.008	0.015	0.017	0.03	0.037	0.039	0.025	0.032	0.034
2.1-2.2	Modular cast iron	<850	180	0.017	0.023	0.025	0.007	0.013	0.015	0.028	0.035	0.037	0.023	0.03	0.032
3.1-3.2	Malleable cast iron	<800	170	0.017	0.023	0.025	0.007	0.013	0.015	0.028	0.035	0.037	0.023	0.03	0.032

ADVICE | The values marked in turquoise are side applications!
 Values in the table are the shortest and the longest overhang length (L3) of each dimension;
 Please calculate fz, ap and ae depending on the given values. ae/ap(max) = 0.5x corner radius!

Cooling	
Tolerance	d04
Coating	AlphaDura Navy

Strategy	HSC HPC	
Application		
Features	HA	

- Ultrafine carbide grade developed for machining hardened steels
 - Optimized face geometry for long tool life and highest dimensional accuracy
 - Reinforced core for milling up to 70 HRC
-
- Multipass milling of 3D contours
-
- Tolerance D1: -0.001/-0.006 mm
 - Tolerance D3: 0/-0.02 mm
 - Radius tolerance r: 0/-0.003 mm (measured from 0-90°)

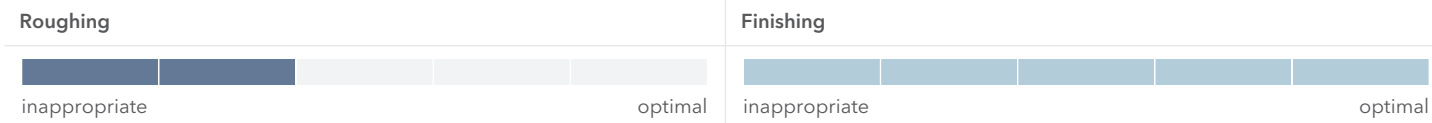
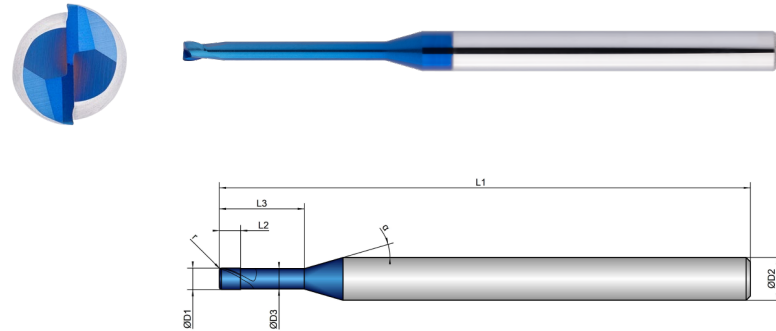

K202092	D1 mm ∅	D3 mm ∅	L2 mm	L3 mm	L1 mm	D2 mm ∅	z #	r mm		
0,8X4	0.8	0.78	0.8	4.0	50.0	4.0	2	0.20	30	16
0,8X6	0.8	0.78	0.8	6.0	50.0	4.0	2	0.20	30	16
1X2	1.0	0.95	1.0	2.0	50.0	4.0	2	0.20	30	16
1X4	1.0	0.95	1.0	4.0	50.0	4.0	2	0.20	30	16
1X6	1.0	0.95	1.0	6.0	50.0	4.0	2	0.20	30	16
1X8	1.0	0.95	1.0	8.0	50.0	4.0	2	0.20	30	16
1X10	1.0	0.95	1.0	10.0	50.0	4.0	2	0.20	30	16
1X12	1.0	0.95	1.0	12.0	54.0	4.0	2	0.20	30	16
1X16	1.0	0.95	1.0	16.0	60.0	4.0	2	0.20	30	16
1X20	1.0	0.95	1.0	20.0	60.0	4.0	2	0.20	30	16
1,2X6	1.2	1.14	1.2	6.0	50.0	4.0	2	0.20	30	16

K202092	D1 mm ∅	D3 mm ∅	L2 mm	L3 mm	L1 mm	D2 mm ∅	z #	r mm		
1,2X12	1.2	1.14	1.2	12.0	54.0	4.0	2	0.20	30	16
1,2X20	1.2	1.14	1.2	20.0	60.0	4.0	2	0.20	30	16
1,5X4	1.5	1.44	1.5	4.0	50.0	4.0	2	0.20	30	16
1,5X6	1.5	1.44	1.5	6.0	50.0	4.0	2	0.20	30	16
1,5X8	1.5	1.44	1.5	8.0	50.0	4.0	2	0.20	30	16
1,5X10	1.5	1.44	1.5	10.0	50.0	4.0	2	0.20	30	16
1,5X12	1.5	1.44	1.5	12.0	54.0	4.0	2	0.20	30	16
1,5X16	1.5	1.44	1.5	16.0	54.0	4.0	2	0.20	30	16
1,5X20	1.5	1.44	1.5	20.0	60.0	4.0	2	0.20	30	16
2X4	2.0	1.91	2.0	4.0	50.0	4.0	2	0.20	30	16
2X6	2.0	1.91	2.0	6.0	50.0	4.0	2	0.20	30	16
2X8	2.0	1.91	2.0	8.0	50.0	4.0	2	0.20	30	16
2X10	2.0	1.91	2.0	10.0	50.0	4.0	2	0.20	30	16
2X12	2.0	1.91	2.0	12.0	54.0	4.0	2	0.20	30	16
2X16	2.0	1.91	2.0	16.0	54.0	4.0	2	0.20	30	16
2X20	2.0	1.91	2.0	20.0	60.0	4.0	2	0.20	30	16
2X26	2.0	1.91	2.0	26.0	70.0	4.0	2	0.20	30	16

Material	Hardness in HRC	Dimension	Infeed in mm	Application	Ø0.8x4			Ø0.8x6			Ø1x2			Ø1x20		
					ae=1xD	ae=0.1xD	ae=0.1xD	ae=1xD	ae=0.1xD	ae=0.1xD	ae=1xD	ae=0.1xD	ae=0.1xD	ae=1xD	ae=0.01xD	ae=0.01xD
H HARDENED STEEL					Vc (m/min)											
1.1	46-55	110	0.014	0.017	0.019	0.014	0.017	0.019	0.015	0.02	0.022	0.007	0.01	0.012		
1.2	56-60	70	0.013	0.016	0.018	0.013	0.016	0.018	0.014	0.019	0.021	0.006	0.009	0.011		
1.3	60-65	50	0.012	0.015	0.017	0.012	0.015	0.017	0.012	0.017	0.019	0.005	0.008	0.01		
1.4	66-70	40	0.011	0.014	0.016	0.011	0.014	0.016	0.011	0.016	0.018	0.004	0.007	0.009		

Material	Strength (N/mm ²)	Feed (mm/Z)	Strength (N/mm ²)											
			fz	fz	fz	fz	fz	fz	fz	fz	fz	fz	fz	fz
M STAINLESS STEEL			Vc (m/min)											
1.1	ferritic/martensitic <850	90	0.015	0.018	0.02	0.015	0.018	0.02	0.016	0.021	0.023	0.006	0.011	0.013
2.1	austenitic <650	75	0.014	0.017	0.019	0.014	0.017	0.019	0.015	0.02	0.022	0.005	0.01	0.012
2.2	austenitic <750	70	0.013	0.016	0.018	0.013	0.016	0.018	0.013	0.018	0.02	0.004	0.008	0.01
3.1	super austenitic <1100	50	0.012	0.015	0.017	0.012	0.015	0.017	0.012	0.017	0.019	0.003	0.007	0.009

Material	Hardness in HRC	Feed (mm/Z)	Strength (N/mm ²)											
			fz	fz	fz	fz	fz	fz	fz	fz	fz	fz	fz	fz
N COPPER			Vc (m/min)											
Tungsten Copper (WCu) <700		110	0.015	0.018	0.02	0.015	0.018	0.02	0.016	0.021	0.023	0.006	0.011	0.013

Material	Hardness in HRC	Feed (mm/Z)	Strength (N/mm ²)											
			fz	fz	fz	fz	fz	fz	fz	fz	fz	fz	fz	fz
P STEEL			Vc (m/min)											
1.1	unalloyed <500	190	0.017	0.022	0.024	0.017	0.022	0.024	0.018	0.025	0.027	0.008	0.015	0.017
1.2-1.5	unalloyed <1100	180	0.017	0.022	0.024	0.017	0.022	0.024	0.018	0.025	0.027	0.008	0.015	0.017
2.1-2.2	low-alloyed <950	170	0.016	0.02	0.022	0.016	0.02	0.022	0.017	0.023	0.024	0.007	0.013	0.015
2.3-2.4	low-alloyed <1300	150	0.016	0.02	0.022	0.016	0.02	0.022	0.017	0.023	0.024	0.007	0.013	0.015
3.1-3.2	high-alloyed <1100	150	0.015	0.018	0.02	0.015	0.018	0.02	0.016	0.021	0.023	0.006	0.011	0.013
3.3	high-alloyed <1400	130	0.014	0.017	0.019	0.014	0.017	0.019	0.015	0.02	0.022	0.005	0.01	0.012

Material	Hardness in HRC	Feed (mm/Z)	Strength (N/mm ²)											
			fz	fz	fz	fz	fz	fz	fz	fz	fz	fz	fz	fz
K CASTINGS			Vc (m/min)											
1.1-1.2	Grey cast iron <1000	190	0.017	0.022	0.024	0.017	0.022	0.024	0.018	0.025	0.027	0.008	0.015	0.017
2.1-2.2	Modular cast iron <850	180	0.016	0.02	0.022	0.016	0.02	0.022	0.017	0.023	0.025	0.007	0.013	0.015
3.1-3.2	Malleable cast iron <800	170	0.016	0.02	0.022	0.016	0.02	0.022	0.017	0.023	0.025	0.007	0.013	0.015

ADVICE | The values marked in turquoise are side applications!
 Values in the table are the shortest and the longest overhang length (L3) of each dimension;
 Please calculate fz, ap and ae depending on the given values.  ae/ap(max) = 0.5x corner radius!

Material	Hardness in HRC	Dimension	Infeed in mm	Application	Ø1.2x6			Ø1.2x20			Ø1.5x4			Ø1.5x20		
					ae=1xD	ae=0.1xD	ae=0.1xD	ae=1xD	ae=0.02xD	ae=0.015xD	ae=1xD	ae=0.1xD	ae=0.1xD	ae=1xD	ae=0.04xD	ae=0.04xD
H HARDENED STEEL					Vc (m/min)											
1.1	46-55	110	0.015	0.02	0.022	0.01	0.015	0.017	0.017	0.022	0.024	0.01	0.015	0.017		
1.2	56-60	70	0.014	0.019	0.021	0.009	0.014	0.016	0.016	0.021	0.022	0.009	0.014	0.016		
1.3	60-65	50	0.012	0.017	0.019	0.007	0.012	0.014	0.014	0.019	0.02	0.007	0.012	0.014		
1.4	66-70	40	0.011	0.016	0.018	0.006	0.011	0.013	0.013	0.018	0.019	0.006	0.011	0.013		

Material	Strength (N/mm ²)	Feed (mm/Z)	Strength (N/mm ²)											
			fz	fz	fz	fz	fz	fz	fz	fz	fz	fz	fz	fz
M STAINLESS STEEL			Vc (m/min)											
1.1	ferritic/martensitic <850	90	0.016	0.021	0.023	0.011	0.016	0.018	0.018	0.023	0.025	0.011	0.016	0.018
2.1	austenitic <650	75	0.015	0.02	0.022	0.01	0.015	0.017	0.017	0.022	0.024	0.01	0.015	0.017
2.2	austenitic <750	70	0.013	0.018	0.02	0.008	0.013	0.015	0.015	0.02	0.022	0.008	0.013	0.015
3.1	super austenitic <1100	50	0.012	0.017	0.019	0.007	0.012	0.014	0.014	0.019	0.021	0.007	0.012	0.014

Material	Hardness in HRC	Feed (mm/Z)	Strength (N/mm ²)											
			fz	fz	fz	fz	fz	fz	fz	fz	fz	fz	fz	fz
N COPPER			Vc (m/min)											
Tungsten Copper (WCu) <700		110	0.016	0.021	0.023	0.011	0.016	0.018	0.018	0.023	0.025	0.011	0.016	0.018

Material	Hardness in HRC	Feed (mm/Z)	Strength (N/mm ²)											
			fz	fz	fz	fz	fz	fz	fz	fz	fz	fz	fz	fz
P STEEL			Vc (m/min)											
1.1	unalloyed <500	190	0.02	0.025	0.027	0.015	0.02	0.022	0.022	0.027	0.029	0.015	0.02	0.022
1.2-1.5	unalloyed <1100	180	0.02	0.025	0.027	0.015	0.02	0.022	0.022	0.027	0.029	0.015	0.02	0.022
2.1-2.2	low-alloyed <950	170	0.018	0.023	0.025	0.013	0.018	0.02	0.02	0.025	0.027	0.013	0.018	0.02
2.3-2.4	low-alloyed <1300	150	0.018	0.023	0.025	0.013	0.018	0.02	0.02	0.025	0.027	0.013	0.018	0.02
3.1-3.2	high-alloyed <1100	150	0.016	0.021	0.023	0.011	0.016	0.018	0.018	0.023	0.025	0.011	0.016	0.018
3.3	high-alloyed <1400	130	0.015	0.02	0.022	0.01	0.015	0.017	0.017	0.022	0.024	0.01	0.015	0.017

Material	Hardness in HRC	Feed (mm/Z)	Strength (N/mm ²)											
			fz	fz	fz	fz	fz	fz	fz	fz	fz	fz	fz	fz
K CASTINGS			Vc (m/min)											
1.1-1.2	Grey cast iron <1000	190	0.02	0.025	0.027	0.015	0.02	0.022	0.022	0.027	0.029	0.015	0.02	0.022
2.1-2.2	Modular cast iron <850	180	0.018	0.023	0.025	0.013	0.018	0.02	0.02	0.025	0.027	0.013	0.018	0.02
3.1-3.2	Malleable cast iron <800	170	0.018	0.023	0.025	0.013	0.018	0.02	0.02	0.025	0.027	0.013	0.018	0.02

ADVICE | The values marked in turquoise are side applications!
 Values in the table are the shortest and the longest overhang length (L3) of each dimension;
 Please calculate fz, ap and ae depending on the given values.  ae/ap(max) = 0.5x corner radius!

Dimension	Ø2x4			Ø2x26		
Infeed in mm	ae= 1xD	ae= 0.1xD	ae= 0.1xD	ae= 1xD	ae= 0.06xD	ae= 0.05xD
	ap= 0.05xD	ap= L2 max	ap= 0.1xD	ap= 0.03xD	ap= L2 max	ap= 0.05xD
Application						

Material	Hardness in HRC	Feed (mm/Z)	Strength					
			fz	fz	fz	fz	fz	fz
H HARDENED STEEL		Vc (m/min)						
1.1	46-55	110	0.025	0.03	0.032	0.02	0.025	0.027
1.2	56-60	70	0.023	0.028	0.03	0.019	0.024	0.026
1.3	60-65	50	0.021	0.026	0.028	0.018	0.023	0.025
1.4	66-70	40	0.019	0.025	0.027	0.017	0.022	0.024

Material	Strength (N/mm²)	Feed (mm/Z)	Strength					
			fz	fz	fz	fz	fz	fz
M STAINLESS STEEL		Vc (m/min)						
1.1 ferritic/martensitic	<850	90	0.026	0.031	0.033	0.021	0.026	0.028
2.1 austenitic	<650	75	0.024	0.029	0.031	0.019	0.025	0.027
2.2 austenitic	<750	70	0.022	0.027	0.029	0.017	0.024	0.026
3.1 DUPLEX STEEL super austenitic	<1100	50	0.02	0.025	0.027	0.015	0.023	0.025

Material	Hardness in HRC	Feed (mm/Z)	Strength					
			fz	fz	fz	fz	fz	fz
N COPPER		Vc (m/min)						
Tungsten Copper (WCu)	<700	110	0.026	0.031	0.033	0.021	0.026	0.028

Material	Hardness in HRC	Feed (mm/Z)	Strength					
			fz	fz	fz	fz	fz	fz
P STEEL		Vc (m/min)						
1.1 unalloyed	<500	190	0.03	0.037	0.039	0.025	0.032	0.034
1.2-1.5 unalloyed	<1100	180	0.03	0.037	0.039	0.025	0.032	0.034
2.1-2.2 low-alloyed	<950	170	0.028	0.035	0.037	0.023	0.03	0.032
2.3-2.4 low-alloyed	<1300	150	0.028	0.035	0.037	0.023	0.03	0.032
3.1-3.2 high-alloyed	<1100	150	0.026	0.032	0.034	0.021	0.027	0.029
3.3 high-alloyed	<1400	130	0.025	0.03	0.032	0.02	0.025	0.027

Material	Hardness in HRC	Feed (mm/Z)	Strength					
			fz	fz	fz	fz	fz	fz
K CASTINGS		Vc (m/min)						
1.1-1.2 Grey cast iron	<1000	190	0.03	0.037	0.039	0.025	0.032	0.034
2.1-2.2 Modular cast iron	<850	180	0.028	0.035	0.037	0.023	0.03	0.032
3.1-3.2 Malleable cast iron	<800	170	0.028	0.035	0.037	0.023	0.03	0.032

ADVICE | The values marked in turquoise are side applications!
 Values in the table are the shortest and the longest overhang length (L3) of each dimension;
 Please calculate fz, ap and ae depending on the given values.

ae/ap(max) = 0.5x corner radius!



Cooling	
Tolerance	d04
Coating	AlphaDura Navy

Strategy	HSC HPC	
Application		
Features	HA	

- Ultrafine carbide grade developed for machining hardened steels
 - Optimized face geometry for long tool life and highest dimensional accuracy
 - Reinforced core for milling up to 70 HRC
-
- Multipass milling of 3D contours
-
- Tolerance D1: -0.001/-0.006 mm
 - Tolerance D3: 0/-0.02 mm
 - Radius tolerance r: 0/-0.003 mm (measured from 0-90°)

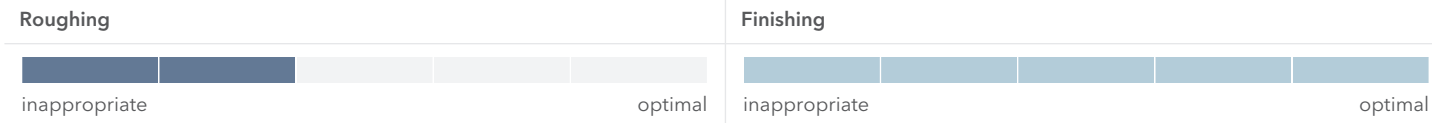
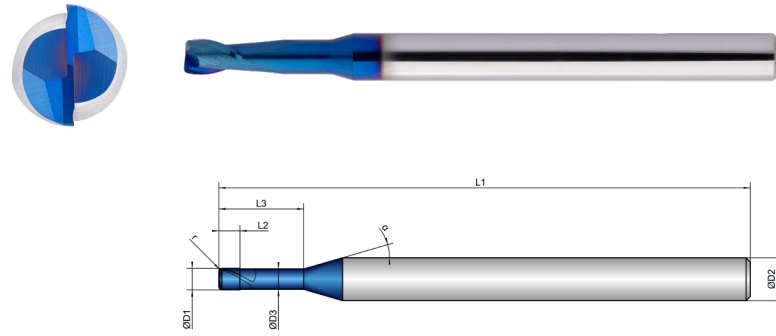

K202102	D1 mm ∅	D3 mm ∅	L2 mm	L3 mm	L1 mm	D2 mm ∅	z #	r mm		
1X2	1.0	0.95	1.0	2.0	50.0	4.0	2	0.30	30	16
1X4	1.0	0.95	1.0	4.0	50.0	4.0	2	0.30	30	16
1X6	1.0	0.95	1.0	6.0	50.0	4.0	2	0.30	30	16
1X8	1.0	0.95	1.0	8.0	50.0	4.0	2	0.30	30	16
1X10	1.0	0.95	1.0	10.0	50.0	4.0	2	0.30	30	16
1X12	1.0	0.95	1.0	12.0	54.0	4.0	2	0.30	30	16
1X16	1.0	0.95	1.0	16.0	60.0	4.0	2	0.30	30	16
1X20	1.0	0.95	1.0	20.0	60.0	4.0	2	0.30	30	16
1,2X6	1.2	1.14	1.2	6.0	50.0	4.0	2	0.30	30	16
1,2X12	1.2	1.14	1.2	12.0	54.0	4.0	2	0.30	30	16
1,2X20	1.2	1.14	1.2	20.0	60.0	4.0	2	0.30	30	16
1,5X4	1.5	1.44	1.5	4.0	50.0	4.0	2	0.30	30	16

K202102	D1 mm ∅	D3 mm ∅	L2 mm	L3 mm	L1 mm	D2 mm ∅	z #	r mm		
1,5X6	1.5	1.44	1.5	6.0	50.0	4.0	2	0.30	30	16
1,5X8	1.5	1.44	1.5	8.0	50.0	4.0	2	0.30	30	16
1,5X10	1.5	1.44	1.5	10.0	50.0	4.0	2	0.30	30	16
1,5X12	1.5	1.44	1.5	12.0	54.0	4.0	2	0.30	30	16
1,5X16	1.5	1.44	1.5	16.0	54.0	4.0	2	0.30	30	16
1,5X20	1.5	1.44	1.5	20.0	60.0	4.0	2	0.30	30	16
2X4	2.0	1.91	2.0	4.0	50.0	4.0	2	0.30	30	16
2X6	2.0	1.91	2.0	6.0	50.0	4.0	2	0.30	30	16
2X8	2.0	1.91	2.0	8.0	50.0	4.0	2	0.30	30	16
2X10	2.0	1.91	2.0	10.0	50.0	4.0	2	0.30	30	16
2X12	2.0	1.91	2.0	12.0	54.0	4.0	2	0.30	30	16
2X16	2.0	1.91	2.0	16.0	54.0	4.0	2	0.30	30	16
2X20	2.0	1.91	2.0	20.0	60.0	4.0	2	0.30	30	16
2X26	2.0	1.91	2.0	26.0	70.0	4.0	2	0.30	30	16
2,5X10	2.5	2.41	2.5	10.0	50.0	4.0	2	0.30	30	16
2,5X12	2.5	2.41	2.5	12.0	60.0	4.0	2	0.30	30	16
2,5X30	2.5	2.41	2.5	30.0	70.0	4.0	2	0.30	30	16
3X10	3.0	2.92	4.5	10.0	50.0	4.0	2	0.30	30	16
3X12	3.0	2.92	4.5	12.0	50.0	4.0	2	0.30	30	16
3X30	3.0	2.92	4.5	30.0	70.0	4.0	2	0.30	30	16

Material	Hardness in HRC	Dimension	Infeed in mm	Ø1x2			Ø1x20			Ø1.2x6			Ø1.2x20		
				ae=1xD	ae=0.1xD	ae=0.1xD	ae=1xD	ae=0.01xD	ae=0.01xD	ae=1xD	ae=0.1xD	ae=0.1xD	ae=1xD	ae=0.02xD	ae=0.015xD
				ap=0.05xD			ap=L2 max			ap=L2 max			ap=L2 max		
				Application			Application			Application			Application		
				Feed (mm/Z)			Feed (mm/Z)			Feed (mm/Z)			Feed (mm/Z)		
H HARDENED STEEL				Vc (m/min)											
1.1	46-55	110	0.015	0.02	0.022	0.007	0.01	0.012	0.015	0.02	0.022	0.01	0.015	0.017	
1.2	56-60	70	0.014	0.019	0.021	0.006	0.009	0.011	0.014	0.019	0.021	0.009	0.014	0.016	
1.3	60-65	50	0.012	0.017	0.019	0.005	0.008	0.01	0.012	0.017	0.019	0.007	0.012	0.014	
1.4	66-70	40	0.011	0.016	0.018	0.004	0.007	0.009	0.011	0.016	0.018	0.006	0.011	0.013	

Material	Strength (N/mm²)	Feed (mm/Z)	Strength (N/mm²)											
			fz	fz	fz	fz	fz	fz	fz	fz	fz	fz	fz	fz
M STAINLESS STEEL			Vc (m/min)											
1.1	ferritic/martensitic <850	90	0.016	0.021	0.023	0.006	0.011	0.013	0.016	0.021	0.023	0.011	0.016	0.018
2.1	austenitic <650	75	0.015	0.02	0.022	0.005	0.01	0.012	0.015	0.02	0.022	0.01	0.015	0.017
2.2	austenitic <750	70	0.013	0.018	0.02	0.004	0.008	0.01	0.013	0.018	0.02	0.008	0.013	0.015
3.1	DUPLEX STEEL super austenitic <1100	50	0.012	0.017	0.019	0.003	0.007	0.009	0.012	0.017	0.019	0.007	0.012	0.014

Material	Hardness in HRC	Feed (mm/Z)	Strength (N/mm²)											
			fz	fz	fz	fz	fz	fz	fz	fz	fz	fz	fz	fz
N COPPER			Vc (m/min)											
Tungsten Copper (WCu)	<700	110	0.016	0.021	0.023	0.006	0.011	0.013	0.016	0.021	0.023	0.011	0.016	0.018

Material	Hardness in HRC	Feed (mm/Z)	Strength (N/mm²)											
			fz	fz	fz	fz	fz	fz	fz	fz	fz	fz	fz	fz
P STEEL			Vc (m/min)											
1.1	unalloyed <500	190	0.018	0.025	0.027	0.008	0.015	0.017	0.02	0.025	0.027	0.015	0.02	0.022
1.2-1.5	unalloyed <1100	180	0.018	0.025	0.027	0.008	0.015	0.017	0.02	0.025	0.027	0.015	0.02	0.022
2.1-2.2	low-alloyed <950	170	0.017	0.023	0.024	0.007	0.013	0.015	0.018	0.023	0.025	0.013	0.018	0.02
2.3-2.4	low-alloyed <1300	150	0.017	0.023	0.024	0.007	0.013	0.015	0.018	0.023	0.025	0.013	0.018	0.02
3.1-3.2	high-alloyed <1100	150	0.016	0.021	0.023	0.006	0.011	0.013	0.016	0.021	0.023	0.011	0.016	0.018
3.3	high-alloyed <1400	130	0.015	0.02	0.022	0.005	0.01	0.012	0.015	0.02	0.022	0.01	0.015	0.017

Material	Hardness in HRC	Feed (mm/Z)	Strength (N/mm²)											
			fz	fz	fz	fz	fz	fz	fz	fz	fz	fz	fz	fz
K CASTINGS			Vc (m/min)											
1.1-1.2	Grey cast iron <1000	190	0.018	0.025	0.027	0.008	0.015	0.017	0.02	0.025	0.027	0.015	0.02	0.022
2.1-2.2	Modular cast iron <850	180	0.017	0.023	0.025	0.007	0.013	0.015	0.018	0.023	0.025	0.013	0.018	0.02
3.1-3.2	Malleable cast iron <800	170	0.017	0.023	0.025	0.007	0.013	0.015	0.018	0.023	0.025	0.013	0.018	0.02

ADVICE | The values marked in turquoise are side applications!
 Values in the table are the shortest and the longest overhang length (L3) of each dimension;
 Please calculate fz, ap and ae depending on the given values. ae/ap(max) = 0.5x corner radius!

Material	Hardness in HRC	Dimension	Infeed in mm	Ø1.5x4			Ø1.5x20			Ø2x4			Ø2x26		
				ae=1xD	ae=0.1xD	ae=0.1xD	ae=1xD	ae=0.04xD	ae=0.04xD	ae=1xD	ae=0.1xD	ae=0.1xD	ae=1xD	ae=0.06xD	ae=0.05xD
				ap=0.05xD			ap=L2 max			ap=L2 max			ap=L2 max		
				Application			Application			Application			Application		
				Feed (mm/Z)			Feed (mm/Z)			Feed (mm/Z)			Feed (mm/Z)		
H HARDENED STEEL				Vc (m/min)											
1.1	46-55	110	0.017	0.022	0.024	0.01	0.015	0.017	0.025	0.03	0.032	0.02	0.025	0.027	
1.2	56-60	70	0.016	0.021	0.022	0.009	0.014	0.016	0.023	0.028	0.03	0.019	0.024	0.026	
1.3	60-65	50	0.014	0.019	0.02	0.007	0.012	0.014	0.021	0.026	0.028	0.018	0.023	0.025	
1.4	66-70	40	0.013	0.018	0.019	0.006	0.011	0.013	0.019	0.025	0.027	0.017	0.022	0.024	

Material	Strength (N/mm²)	Feed (mm/Z)	Strength (N/mm²)											
			fz	fz	fz	fz	fz	fz	fz	fz	fz	fz	fz	fz
M STAINLESS STEEL			Vc (m/min)											
1.1	ferritic/martensitic <850	90	0.018	0.023	0.025	0.011	0.016	0.018	0.026	0.031	0.033	0.021	0.026	0.028
2.1	austenitic <650	75	0.017	0.022	0.024	0.01	0.015	0.017	0.024	0.029	0.031	0.019	0.025	0.027
2.2	austenitic <750	70	0.015	0.02	0.022	0.008	0.013	0.015	0.022	0.027	0.029	0.017	0.024	0.026
3.1	DUPLEX STEEL super austenitic <1100	50	0.014	0.019	0.021	0.007	0.012	0.014	0.02	0.025	0.027	0.015	0.023	0.025

Material	Hardness in HRC	Feed (mm/Z)	Strength (N/mm²)											
			fz	fz	fz	fz	fz	fz	fz	fz	fz	fz	fz	fz
N COPPER			Vc (m/min)											
Tungsten Copper (WCu)	<700	110	0.018	0.023	0.025	0.011	0.016	0.018	0.026	0.031	0.033	0.021	0.026	0.028

Material	Hardness in HRC	Feed (mm/Z)	Strength (N/mm²)											
			fz	fz	fz	fz	fz	fz	fz	fz	fz	fz	fz	fz
P STEEL			Vc (m/min)											
1.1	unalloyed <500	190	0.022	0.027	0.029	0.015	0.02	0.022	0.03	0.037	0.039	0.025	0.032	0.034
1.2-1.5	unalloyed <1100	180	0.022	0.027	0.029	0.015	0.02	0.022	0.03	0.037	0.039	0.025	0.032	0.034
2.1-2.2	low-alloyed <950	170	0.02	0.025	0.027	0.013	0.018	0.02	0.028	0.035	0.037	0.023	0.03	0.032
2.3-2.4	low-alloyed <1300	150	0.02	0.025	0.027	0.013	0.018	0.02	0.028	0.035	0.037	0.023	0.03	0.032
3.1-3.2	high-alloyed <1100	150	0.018	0.023	0.025	0.011	0.016	0.018	0.026	0.032	0.034	0.021	0.027	0.029
3.3	high-alloyed <1400	130	0.017	0.022	0.024	0.01	0.015	0.017	0.025	0.03	0.032	0.02	0.025	0.027

Material	Hardness in HRC	Feed (mm/Z)	Strength (N/mm²)											
			fz	fz	fz	fz	fz	fz	fz	fz	fz	fz	fz	fz
K CASTINGS			Vc (m/min)											
1.1-1.2	Grey cast iron <1000	190	0.022	0.027	0.029	0.015	0.02	0.022	0.03	0.037	0.039	0.025	0.032	0.034
2.1-2.2	Modular cast iron <850	180	0.02	0.025	0.027	0.013	0.018	0.02	0.028	0.035	0.037	0.023	0.03	0.032
3.1-3.2	Malleable cast iron <800	170	0.02	0.025	0.027	0.013	0.018	0.02	0.028	0.035	0.037	0.023	0.03	0.032

ADVICE | The values marked in turquoise are side applications!
 Values in the table are the shortest and the longest overhang length (L3) of each dimension;
 Please calculate fz, ap and ae depending on the given values. ae/ap(max) = 0.5x corner radius!

Material	Hardness in HRC	Dimension	Ø2.5x10			Ø2.5x30			Ø3x10			Ø3x30			
			ae=1xD	ae=0.1xD	ae=0.1xD	ae=1xD	ae=0.04xD	ae=0.04xD	ae=1xD	ae=0.1xD	ae=0.1xD	ae=1xD	ae=0.05xD	ae=0.05xD	
		Infeed in mm	ap=0.05xD	ap=L2 max	ap=0.1xD	ap=0.02xD	ap=L2 max	ap=0.04xD	ap=0.05xD	ap=L2 max	ap=0.1xD	ap=0.03xD	ap=L2 max	ap=0.05xD	
		Application													
		Feed (mm/Z)	fz	fz	fz	fz	fz	fz	fz	fz	fz	fz	fz	fz	
H HARDENED STEEL		Vc (m/min)													
1.1	46-55	110	0.025	0.03	0.032	0.02	0.025	0.027	0.027	0.032	0.034	0.017	0.022	0.024	
1.2	56-60	70	0.023	0.028	0.03	0.019	0.024	0.026	0.025	0.03	0.032	0.015	0.02	0.022	
1.3	60-65	50	0.021	0.026	0.028	0.018	0.023	0.025	0.023	0.028	0.03	0.013	0.018	0.02	
1.4	66-70	40	0.019	0.025	0.027	0.017	0.022	0.024	0.021	0.026	0.028	0.011	0.016	0.018	
M STAINLESS STEEL		Vc (m/min)													
1.1	ferritic/martensitic	<850	90	0.026	0.031	0.033	0.021	0.026	0.028	0.028	0.033	0.034	0.018	0.023	0.025
2.1	austenitic	<650	75	0.024	0.029	0.031	0.019	0.024	0.026	0.026	0.031	0.033	0.016	0.021	0.023
2.2	austenitic	<750	70	0.022	0.027	0.029	0.017	0.022	0.024	0.024	0.029	0.031	0.014	0.019	0.021
3.1	DUPLEX STEEL super austenitic	<1100	50	0.02	0.026	0.028	0.016	0.02	0.022	0.022	0.027	0.029	0.012	0.017	0.019
N COPPER		Vc (m/min)													
	Tungsten Copper (WCu)	<700	110	0.026	0.031	0.033	0.021	0.026	0.028	0.028	0.033	0.034	0.018	0.023	0.025
P STEEL		Vc (m/min)													
1.1	unalloyed	<500	190	0.03	0.036	0.038	0.025	0.031	0.033	0.032	0.038	0.04	0.022	0.028	0.03
1.2-1.5	unalloyed	<1100	180	0.03	0.036	0.038	0.025	0.031	0.033	0.032	0.038	0.04	0.022	0.028	0.03
2.1-2.2	low-alloyed	<950	170	0.028	0.034	0.036	0.023	0.029	0.031	0.03	0.036	0.038	0.02	0.026	0.028
2.3-2.4	low-alloyed	<1300	150	0.028	0.034	0.036	0.023	0.029	0.031	0.03	0.036	0.038	0.02	0.026	0.028
3.1-3.2	high-alloyed	<1100	150	0.026	0.031	0.033	0.021	0.026	0.028	0.028	0.033	0.035	0.018	0.023	0.025
3.3	high-alloyed	<1400	130	0.025	0.03	0.032	0.02	0.025	0.027	0.027	0.032	0.034	0.017	0.022	0.024
K CASTINGS		Vc (m/min)													
1.1-1.2	Grey cast iron	<1000	190	0.03	0.036	0.038	0.025	0.031	0.033	0.032	0.038	0.04	0.022	0.028	0.03
2.1-2.2	Modular cast iron	<850	180	0.028	0.034	0.036	0.023	0.029	0.031	0.03	0.036	0.038	0.02	0.028	0.028
3.1-3.2	Malleable cast iron	<800	170	0.028	0.034	0.036	0.023	0.029	0.031	0.03	0.036	0.038	0.02	0.026	0.028

ADVICE | The values marked in turquoise are side applications!
 Values in the table are the shortest and the longest overhang length (L3) of each dimension;
 Please calculate fz, ap and ae depending on the given values. ae/ap(max) = 0.5x corner radius!



STILL CAN'T FIND A SUITABLE MILLING CUTTER?

No problem - simply customize an existing tool. Using our configurator for special milling cutters, you can customize existing tools to your needs in an instant or create your own tools based on predefined types.

WE WILL RESPOND TO ALL REQUESTS SUBMITTED VIA THE CONFIGURATOR WITHIN ONE WORKING DAY AT THE LATEST



Cooling	
Tolerance	d04
Coating	AlphaDura Navy

Strategy	HSC HPC	
Application		
Features	HA	

- Ultrafine carbide grade developed for machining hardened steels
 - Optimized face geometry for long tool life and highest dimensional accuracy
 - Reinforced core for milling up to 70 HRC
-
- Multipass milling of 3D contours
-
- Tolerance D1: -0.001/-0.006 mm
 - Tolerance D3: 0/-0.02 mm
 - Radius tolerance r: 0/-0.003 mm (measured from 0-90°)

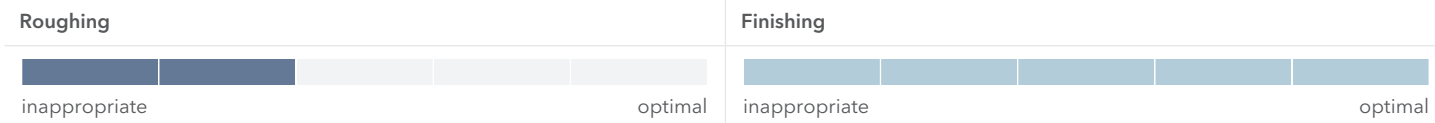
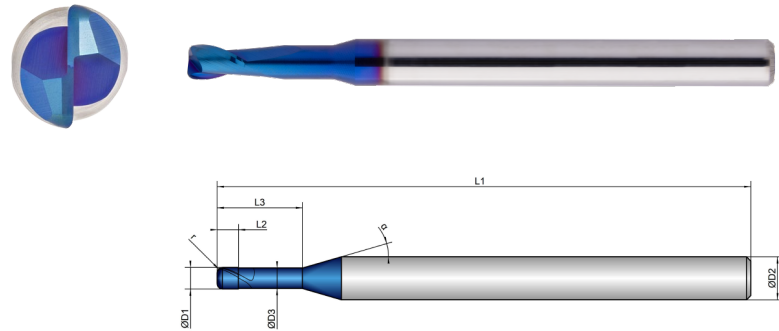

K202112	D1 mm ∅	D3 mm ∅	L2 mm	L3 mm	L1 mm	D2 mm ∅	z #	r mm			α °
1,5X4	1.5	1.44	1.5	4.0	50.0	4.0	2	0.50	30	16	
1,5X6	1.5	1.44	1.5	6.0	50.0	4.0	2	0.50	30	16	
1,5X8	1.5	1.44	1.5	8.0	50.0	4.0	2	0.50	30	16	
1,5X10	1.5	1.44	1.5	10.0	50.0	4.0	2	0.50	30	16	
1,5X12	1.5	1.44	1.5	12.0	54.0	4.0	2	0.50	30	16	
1,5X16	1.5	1.44	1.5	16.0	54.0	4.0	2	0.50	30	16	
1,5X20	1.5	1.44	1.5	20.0	60.0	4.0	2	0.50	30	16	
2X4	2.0	1.91	2.0	4.0	50.0	4.0	2	0.50	30	16	
2X6	2.0	1.91	2.0	6.0	50.0	4.0	2	0.50	30	16	
2X8	2.0	1.91	2.0	8.0	50.0	4.0	2	0.50	30	16	
2X10	2.0	1.91	2.0	10.0	50.0	4.0	2	0.50	30	16	

K202112	D1 mm ∅	D3 mm ∅	L2 mm	L3 mm	L1 mm	D2 mm ∅	z #	r mm			α °
2X12	2.0	1.91	2.0	12.0	54.0	4.0	2	0.50	30	16	
2X16	2.0	1.91	2.0	16.0	54.0	4.0	2	0.50	30	16	
2X20	2.0	1.91	2.0	20.0	60.0	4.0	2	0.50	30	16	
2X26	2.0	1.91	2.0	26.0	70.0	4.0	2	0.50	30	16	
2,5X10	2.5	2.41	2.5	10.0	50.0	4.0	2	0.50	30	16	
2,5X12	2.5	2.41	2.5	12.0	60.0	4.0	2	0.50	30	16	
2,5X30	2.5	2.41	2.5	30.0	70.0	4.0	2	0.50	30	16	
3X10	3.0	2.91	4.5	10.0	50.0	4.0	2	0.50	30	16	
3X12	3.0	2.91	4.5	12.0	50.0	4.0	2	0.50	30	16	
3X30	3.0	2.91	4.5	30.0	70.0	4.0	2	0.50	30	16	

Material	Hardness in HRC	Dimension	Infeed in mm	Application	Ø1.5x4			Ø1.5x20			Ø2x4			Ø2x26		
					ae=1xD	ae=0.1xD	ae=0.1xD	ae=1xD	ae=0.04xD	ae=0.04xD	ae=1xD	ae=0.1xD	ae=0.1xD	ae=1xD	ae=0.05xD	ae=0.05xD
					ap=0.05xD	ap=L2 max	ap=0.1xD	ap=0.02xD	ap=L2 max	ap=0.04xD	ap=0.05xD	ap=L2 max	ap=0.1xD	ap=0.03xD	ap=L2 max	ap=0.05xD
		Feed (mm/Z)	fz	fz	fz	fz	fz	fz	fz	fz	fz	fz	fz	fz		
H	HARDENED STEEL	Vc (m/min)														
1.1	46-55	110	0.017	0.022	0.024	0.01	0.015	0.017	0.025	0.03	0.032	0.02	0.025	0.027		
1.2	56-60	70	0.016	0.021	0.022	0.009	0.014	0.016	0.023	0.028	0.03	0.019	0.024	0.026		
1.3	60-65	50	0.014	0.019	0.02	0.007	0.012	0.014	0.021	0.026	0.028	0.018	0.023	0.025		
1.4	66-70	40	0.013	0.018	0.019	0.006	0.011	0.013	0.019	0.025	0.027	0.017	0.022	0.024		

Material	Strength (N/mm ²)	Feed (mm/Z)	Strength (N/mm ²)											
			fz	fz	fz	fz	fz	fz	fz	fz	fz	fz	fz	fz
M	STAINLESS STEEL	Vc (m/min)												
1.1	ferritic/martensitic <850	90	0.018	0.023	0.025	0.011	0.016	0.018	0.026	0.031	0.033	0.021	0.026	0.028
2.1	austenitic <650	75	0.017	0.022	0.024	0.01	0.015	0.017	0.024	0.029	0.031	0.019	0.025	0.027
2.2	austenitic <750	70	0.015	0.02	0.022	0.008	0.013	0.015	0.022	0.027	0.029	0.017	0.024	0.026
3.1	DUPLEX STEEL super austenitic <1100	50	0.014	0.019	0.021	0.007	0.012	0.014	0.02	0.025	0.027	0.015	0.023	0.025

Material	Hardness in HRC	Feed (mm/Z)	Strength (N/mm ²)											
			fz	fz	fz	fz	fz	fz	fz	fz	fz	fz	fz	fz
N	COPPER	Vc (m/min)												
	Tungsten Copper (WCu) <700	110	0.018	0.023	0.025	0.011	0.016	0.018	0.026	0.031	0.033	0.021	0.026	0.028

Material	Strength (N/mm ²)	Feed (mm/Z)	Strength (N/mm ²)											
			fz	fz	fz	fz	fz	fz	fz	fz	fz	fz	fz	fz
P	STEEL	Vc (m/min)												
1.1	unalloyed <500	190	0.022	0.027	0.029	0.015	0.02	0.022	0.03	0.037	0.039	0.025	0.032	0.034
1.2-1.5	unalloyed <1100	180	0.022	0.027	0.029	0.015	0.02	0.022	0.03	0.037	0.039	0.025	0.032	0.034
2.1-2.2	low-alloyed <950	170	0.02	0.025	0.027	0.013	0.018	0.02	0.028	0.035	0.037	0.023	0.03	0.032
2.3-2.4	low-alloyed <1300	150	0.02	0.025	0.027	0.013	0.018	0.02	0.028	0.035	0.037	0.023	0.03	0.032
3.1-3.2	high-alloyed <1100	150	0.018	0.023	0.025	0.011	0.016	0.018	0.026	0.032	0.034	0.021	0.027	0.029
3.3	high-alloyed <1400	130	0.017	0.022	0.024	0.01	0.015	0.017	0.025	0.03	0.032	0.02	0.025	0.027

Material	Strength (N/mm ²)	Feed (mm/Z)	Strength (N/mm ²)											
			fz	fz	fz	fz	fz	fz	fz	fz	fz	fz	fz	fz
K	CASTINGS	Vc (m/min)												
1.1-1.2	Grey cast iron <1000	190	0.022	0.027	0.029	0.015	0.02	0.022	0.03	0.037	0.039	0.025	0.032	0.034
2.1-2.2	Modular cast iron <850	180	0.02	0.025	0.027	0.013	0.018	0.02	0.028	0.035	0.037	0.023	0.03	0.032
3.1-3.2	Malleable cast iron <800	170	0.02	0.025	0.027	0.013	0.018	0.02	0.028	0.035	0.037	0.023	0.03	0.032

ADVICE | The values marked in turquoise are side applications! Values in the table are the shortest and the longest overhang length (L3) of each dimension; Please calculate fz, ap and ae depending on the given values.  ae/ap(max) = 0.5x corner radius!

Material	Hardness in HRC	Dimension	Infeed in mm	Application	Ø2.5x10			Ø2.5x30			Ø3x10			Ø3x30		
					ae=1xD	ae=0.1xD	ae=0.1xD	ae=1xD	ae=0.04xD	ae=0.04xD	ae=1xD	ae=0.1xD	ae=0.1xD	ae=1xD	ae=0.05xD	ae=0.05xD
					ap=0.05xD	ap=L2 max	ap=0.1xD	ap=0.02xD	ap=L2 max	ap=0.04xD	ap=0.05xD	ap=L2 max	ap=0.1xD	ap=0.03xD	ap=L2 max	ap=0.05xD
		Feed (mm/Z)	fz	fz	fz	fz	fz	fz	fz	fz	fz	fz	fz	fz		
H	HARDENED STEEL	Vc (m/min)														
1.1	46-55	110	0.025	0.03	0.032	0.02	0.025	0.027	0.027	0.032	0.034	0.017	0.022	0.024		
1.2	56-60	70	0.023	0.028	0.03	0.019	0.024	0.026	0.025	0.03	0.032	0.015	0.02	0.022		
1.3	60-65	50	0.021	0.026	0.028	0.018	0.023	0.025	0.023	0.028	0.03	0.013	0.018	0.02		
1.4	66-70	40	0.019	0.025	0.027	0.017	0.022	0.024	0.021	0.026	0.028	0.011	0.016	0.018		

Material	Strength (N/mm ²)	Feed (mm/Z)	Strength (N/mm ²)											
			fz	fz	fz	fz	fz	fz	fz	fz	fz	fz	fz	fz
M	STAINLESS STEEL	Vc (m/min)												
1.1	ferritic/martensitic <850	90	0.026	0.031	0.033	0.021	0.026	0.028	0.028	0.033	0.034	0.018	0.023	0.025
2.1	austenitic <650	75	0.024	0.029	0.031	0.019	0.024	0.026	0.026	0.031	0.033	0.016	0.021	0.023
2.2	austenitic <750	70	0.022	0.027	0.029	0.017	0.022	0.024	0.024	0.029	0.031	0.014	0.019	0.021
3.1	DUPLEX STEEL super austenitic <1100	50	0.02	0.026	0.028	0.016	0.02	0.022	0.022	0.027	0.029	0.012	0.017	0.019

Material	Hardness in HRC	Feed (mm/Z)	Strength (N/mm ²)											
			fz	fz	fz	fz	fz	fz	fz	fz	fz	fz	fz	fz
N	COPPER	Vc (m/min)												
	Tungsten Copper (WCu) <700	110	0.026	0.031	0.033	0.021	0.026	0.028	0.028	0.033	0.034	0.018	0.023	0.025

Material	Strength (N/mm ²)	Feed (mm/Z)	Strength (N/mm ²)											
			fz	fz	fz	fz	fz	fz	fz	fz	fz	fz	fz	fz
P	STEEL	Vc (m/min)												
1.1	unalloyed <500	190	0.03	0.036	0.038	0.025	0.031	0.033	0.032	0.038	0.04	0.022	0.028	0.03
1.2-1.5	unalloyed <1100	180	0.03	0.036	0.038	0.025	0.031	0.033	0.032	0.038	0.04	0.022	0.028	0.03
2.1-2.2	low-alloyed <950	170	0.028	0.034	0.036	0.023	0.029	0.031	0.03	0.036	0.038	0.02	0.026	0.028
2.3-2.4	low-alloyed <1300	150	0.028	0.034	0.036	0.023	0.029	0.031	0.03	0.036	0.038	0.02	0.026	0.028
3.1-3.2	high-alloyed <1100	150	0.026	0.031	0.033	0.021	0.026	0.028	0.028	0.033	0.035	0.018	0.023	0.025
3.3	high-alloyed <1400	130	0.025	0.03	0.032	0.02	0.025	0.027	0.027	0.032	0.034	0.017	0.022	0.024

Material	Strength (N/mm ²)	Feed (mm/Z)	Strength (N/mm ²)											
			fz	fz	fz	fz	fz	fz	fz	fz	fz	fz	fz	fz
K	CASTINGS	Vc (m/min)												
1.1-1.2	Grey cast iron <1000	190	0.03	0.036	0.038	0.025	0.031	0.033	0.032	0.038	0.04	0.022	0.028	0.03
2.1-2.2	Modular cast iron <850	180	0.028	0.034	0.036	0.023	0.029	0.031	0.03	0.036	0.038	0.02	0.028	0.028
3.1-3.2	Malleable cast iron <800	170	0.028	0.034	0.036	0.023	0.029	0.031	0.03	0.036	0.038	0.02	0.026	0.028

ADVICE | The values marked in turquoise are side applications! Values in the table are the shortest and the longest overhang length (L3) of each dimension; Please calculate fz, ap and ae depending on the given values.  ae/ap(max) = 0.5x corner radius!

Cooling	
Tolerance	d04
Coating	AlphaDura Navy

Strategy	HSC	
Application		
Features	HA	

- Ultrafine carbide grade developed for machining hardened steels
- Optimized face geometry for long tool life and highest dimensional accuracy
- Reinforced core for milling up to 70 HRC

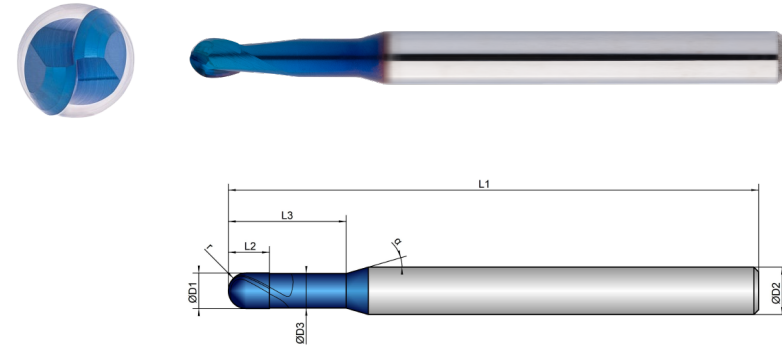



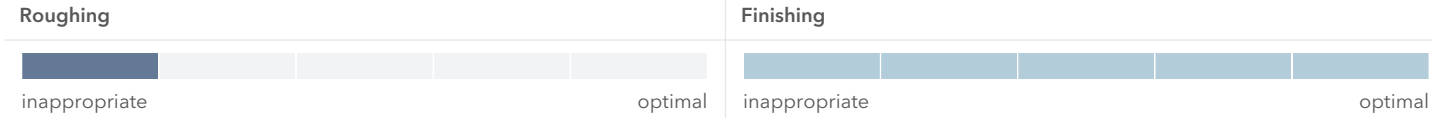



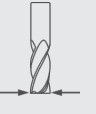
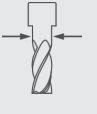
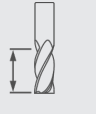
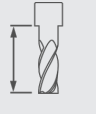
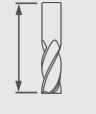
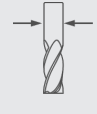

- Tolerance D1: -0.001/-0.006 mm
- Tolerance D3: 0/-0.02 mm
- Radius tolerance r: 0/-0.003 mm (measured from 0-90°)

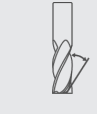

K203206	D1 mm ∅	D3 mm ∅	L2 mm	L3 mm	L1 mm	D2 mm ∅	z #	r mm		α °
0,2X0,3	0.2	0.17	0.16	0.3	45.0	4.0	2	0.10	30	16
0,2X0,5	0.2	0.17	0.16	0.5	45.0	4.0	2	0.10	30	16
0,2X0,75	0.2	0.17	0.16	0.75	45.0	4.0	2	0.10	30	16
0,2X1	0.2	0.17	0.16	1.0	45.0	4.0	2	0.10	30	16
0,2X1,25	0.2	0.17	0.16	1.25	45.0	4.0	2	0.10	30	16
0,2X1,5	0.2	0.17	0.16	1.5	45.0	4.0	2	0.10	30	16
0,2X1,75	0.2	0.17	0.16	1.75	45.0	4.0	2	0.10	30	16
0,2X2	0.2	0.17	0.16	2.0	45.0	4.0	2	0.10	30	16
0,2X2,5	0.2	0.17	0.16	2.5	45.0	4.0	2	0.10	30	16
0,2X3	0.2	0.17	0.16	3.0	45.0	4.0	2	0.10	30	16
0,3X0,5	0.3	0.27	0.24	0.5	45.0	4.0	2	0.15	30	16
0,3X0,75	0.3	0.27	0.24	0.75	45.0	4.0	2	0.15	30	16
0,3X1	0.3	0.27	0.24	1.0	45.0	4.0	2	0.15	30	16
0,3X1,25	0.3	0.27	0.24	1.25	45.0	4.0	2	0.15	30	16

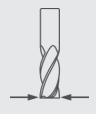
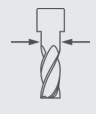
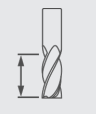
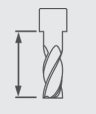
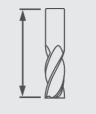
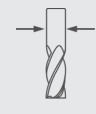
K203206	D1 mm ∅	D3 mm ∅	L2 mm	L3 mm	L1 mm	D2 mm ∅	z #	r mm		α °
0,3X1,5	0.3	0.27	0.24	1.5	45.0	4.0	2	0.15	30	16
0,4X0,5	0.4	0.34	0.32	0.5	45.0	4.0	2	0.20	30	16
0,4X0,75	0.4	0.34	0.32	0.75	45.0	4.0	2	0.20	30	16
0,4X1	0.4	0.34	0.32	1.0	45.0	4.0	2	0.20	30	16
0,4X1,5	0.4	0.34	0.32	1.5	45.0	4.0	2	0.20	30	16
0,4X2	0.4	0.34	0.32	2.0	45.0	4.0	2	0.20	30	16
0,4X2,5	0.4	0.34	0.32	2.5	45.0	4.0	2	0.20	30	16
0,4X3	0.4	0.34	0.32	3.0	45.0	4.0	2	0.20	30	16
0,4X3,5	0.4	0.34	0.32	3.5	45.0	4.0	2	0.20	30	16
0,4X4	0.4	0.34	0.32	4.0	45.0	4.0	2	0.20	30	16
0,4X4,5	0.4	0.34	0.32	4.5	45.0	4.0	2	0.20	30	16
0,4X5	0.4	0.34	0.32	5.0	45.0	4.0	2	0.20	30	16
0,4X5,5	0.4	0.34	0.32	5.5	45.0	4.0	2	0.20	30	16
0,4X6	0.4	0.34	0.32	6.0	45.0	4.0	2	0.20	30	16
0,5X1	0.5	0.47	0.4	1.0	45.0	4.0	2	0.25	30	16
0,5X1,5	0.5	0.47	0.4	1.5	45.0	4.0	2	0.25	30	16
0,5X2	0.5	0.47	0.4	2.0	45.0	4.0	2	0.25	30	16
0,5X2,5	0.5	0.47	0.4	2.5	45.0	4.0	2	0.25	30	16
0,5X3	0.5	0.47	0.4	3.0	45.0	4.0	2	0.25	30	16
0,5X3,5	0.5	0.47	0.4	3.5	45.0	4.0	2	0.25	30	16
0,5X4	0.5	0.47	0.4	4.0	45.0	4.0	2	0.25	30	16
0,5X4,5	0.5	0.47	0.4	4.5	45.0	4.0	2	0.25	30	16
0,5X5	0.5	0.47	0.4	5.0	45.0	4.0	2	0.25	30	16
0,5X5,5	0.5	0.47	0.4	5.5	45.0	4.0	2	0.25	30	16
0,5X6	0.5	0.47	0.4	6.0	45.0	4.0	2	0.25	30	16
0,5X7	0.5	0.47	0.4	7.0	45.0	4.0	2	0.25	30	16
0,5X8	0.5	0.47	0.4	8.0	45.0	4.0	2	0.25	30	16

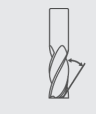
K203206	D1  mm ∅	D3  mm ∅	L2  mm	L3  mm	L1  mm	D2  mm ∅	z  #	r  mm	 °	α  °
0,5X9	0.5	0.47	0.4	9.0	45.0	4.0	2	0.25	30	16
0,6X1	0.6	0.57	0.48	1.0	45.0	4.0	2	0.30	30	16
0,6X2	0.6	0.57	0.48	2.0	45.0	4.0	2	0.30	30	16
0,6X3	0.6	0.57	0.48	3.0	45.0	4.0	2	0.30	30	16
0,6X4	0.6	0.57	0.48	4.0	45.0	4.0	2	0.30	30	16
0,6X5	0.6	0.57	0.48	5.0	45.0	4.0	2	0.30	30	16
0,6X6	0.6	0.57	0.48	6.0	45.0	4.0	2	0.30	30	16
0,6X8	0.6	0.57	0.48	8.0	45.0	4.0	2	0.30	30	16
0,8X2	0.8	0.77	0.64	2.0	45.0	4.0	2	0.40	30	16
0,8X3	0.8	0.77	0.64	3.0	45.0	4.0	2	0.40	30	16
0,8X4	0.8	0.77	0.64	4.0	45.0	4.0	2	0.40	30	16
0,8X5	0.8	0.77	0.64	5.0	45.0	4.0	2	0.40	30	16
0,8X6	0.8	0.77	0.64	6.0	45.0	4.0	2	0.40	30	16
0,8X7	0.8	0.77	0.64	7.0	45.0	4.0	2	0.40	30	16
0,8X8	0.8	0.77	0.64	8.0	45.0	4.0	2	0.40	30	16
0,8X9	0.8	0.77	0.64	9.0	45.0	4.0	2	0.40	30	16
1X2,5	1.0	0.96	0.8	2.5	45.0	4.0	2	0.50	30	16
1X3	1.0	0.96	0.8	3.0	45.0	4.0	2	0.50	30	16
1X4	1.0	0.96	0.8	4.0	45.0	4.0	2	0.50	30	16
1X5	1.0	0.96	0.8	5.0	45.0	4.0	2	0.50	30	16
1X6	1.0	0.96	0.8	6.0	45.0	4.0	2	0.50	30	16
1X7	1.0	0.96	0.8	7.0	45.0	4.0	2	0.50	30	16
1X8	1.0	0.96	0.8	8.0	45.0	4.0	2	0.50	30	16
1X9	1.0	0.96	0.8	9.0	45.0	4.0	2	0.50	30	16
1X10	1.0	0.96	0.8	10.0	45.0	4.0	2	0.50	30	16
1X12	1.0	0.96	0.8	12.0	45.0	4.0	2	0.50	30	16
1,2X6	1.2	1.16	0.96	6.0	45.0	4.0	2	0.60	30	16

K203206	D1  mm ∅	D3  mm ∅	L2  mm	L3  mm	L1  mm	D2  mm ∅	z  #	r  mm	 °	α  °
1,2X8	1.2	1.16	0.96	8.0	45.0	4.0	2	0.60	30	16
1,2X10	1.2	1.16	0.96	10.0	45.0	4.0	2	0.60	30	16
1,2X12	1.2	1.16	0.96	12.0	45.0	4.0	2	0.60	30	16
1,4X8	1.4	1.34	1.12	8.0	45.0	4.0	2	0.70	30	16
1,4X12	1.4	1.34	1.12	12.0	45.0	4.0	2	0.70	30	16
1,5X3	1.5	1.44	1.2	3.0	45.0	4.0	2	0.75	30	16
1,5X4	1.5	1.44	1.2	4.0	45.0	4.0	2	0.75	30	16
1,5X6	1.5	1.44	1.2	6.0	45.0	4.0	2	0.75	30	16
1,5X8	1.5	1.44	1.2	8.0	45.0	4.0	2	0.75	30	16
1,5X10	1.5	1.44	1.2	10.0	45.0	4.0	2	0.75	30	16
1,5X12	1.5	1.44	1.2	12.0	45.0	4.0	2	0.75	30	16
1,6X8	1.6	1.54	1.28	8.0	45.0	4.0	2	0.80	30	16
1,6X12	1.6	1.54	1.28	12.0	45.0	4.0	2	0.80	30	16
1,8X8	1.8	1.74	1.44	8.0	45.0	4.0	2	0.90	30	16
1,8X12	1.8	1.74	1.44	12.0	45.0	4.0	2	0.90	30	16
2X3	2.0	1.94	1.6	3.0	45.0	4.0	2	1.00	30	16
2X4	2.0	1.94	1.6	4.0	45.0	4.0	2	1.00	30	16
2X6	2.0	1.94	1.6	6.0	45.0	4.0	2	1.00	30	16
2X8	2.0	1.94	1.6	8.0	45.0	4.0	2	1.00	30	16
2X10	2.0	1.94	1.6	10.0	45.0	4.0	2	1.00	30	16
2X12	2.0	1.94	1.6	12.0	45.0	4.0	2	1.00	30	16
2,5X10	2.5	2.41	2.0	10.0	45.0	4.0	2	1.25	30	16
3X8	3.0	2.92	3.5	8.0	45.0	4.0	2	1.50	30	16
3X10	3.0	2.92	3.5	10.0	45.0	4.0	2	1.50	30	16
3X12	3.0	2.92	3.5	12.0	45.0	4.0	2	1.50	30	16
3X16	3.0	2.92	3.5	16.0	45.0	4.0	2	1.50	30	16

Material	Hardness in HRC	Feed (mm/Z)	Dimension																															
			00.2 x0.3	00.2 x3	00.3 x0.5	00.3 x1.5	00.4 x0.5	00.4 x6	00.5 x1	00.5 x9	00.6 x1	00.6 x8																						
			<table border="0"> <tr> <td>Infeed in mm</td> <td>ae=0.1xD</td> <td>ae=0.02xD</td> <td>ae=0.1xD</td> <td>ae=0.09xD</td> <td>ae=0.1xD</td> <td>ae=0.02xD</td> <td>ae=0.1xD</td> <td>ae=0.01xD</td> <td>ae=0.1xD</td> <td>ae=0.035xD</td> </tr> <tr> <td>Application</td> <td>ap=0.1xD</td> <td>ap=0.02xD</td> <td>ap=0.1xD</td> <td>ap=0.09xD</td> <td>ap=0.1xD</td> <td>ap=0.02xD</td> <td>ap=0.1xD</td> <td>ap=0.01xD</td> <td>ap=0.1xD</td> <td>ap=0.035xD</td> </tr> </table>										Infeed in mm	ae=0.1xD	ae=0.02xD	ae=0.1xD	ae=0.09xD	ae=0.1xD	ae=0.02xD	ae=0.1xD	ae=0.01xD	ae=0.1xD	ae=0.035xD	Application	ap=0.1xD	ap=0.02xD	ap=0.1xD	ap=0.09xD	ap=0.1xD	ap=0.02xD	ap=0.1xD	ap=0.01xD	ap=0.1xD	ap=0.035xD
Infeed in mm	ae=0.1xD	ae=0.02xD	ae=0.1xD	ae=0.09xD	ae=0.1xD	ae=0.02xD	ae=0.1xD	ae=0.01xD	ae=0.1xD	ae=0.035xD																								
Application	ap=0.1xD	ap=0.02xD	ap=0.1xD	ap=0.09xD	ap=0.1xD	ap=0.02xD	ap=0.1xD	ap=0.01xD	ap=0.1xD	ap=0.035xD																								
			<table border="0"> <tr> <td>Application</td> <td></td> <td></td> <td></td> <td></td> <td></td> <td></td> <td></td> <td></td> <td></td> <td></td> </tr> </table>										Application																					
Application																																		
HARDENED STEEL		Vc (m/min)	fz	fz	fz	fz	fz	fz	fz	fz	fz	fz																						
1.1	46-55	110	0.019	0.014	0.021	0.017	0.023	0.019	0.024	0.018	0.026	0.022																						
1.2	56-60	70	0.018	0.013	0.02	0.016	0.022	0.018	0.023	0.017	0.025	0.021																						
1.3	60-65	50	0.017	0.012	0.019	0.015	0.021	0.017	0.022	0.016	0.024	0.02																						
1.4	66-70	40	0.014	0.009	0.016	0.012	0.018	0.014	0.019	0.013	0.021	0.017																						

Material	Strength (N/mm²)	Feed (mm/Z)	Dimension									
			00.2 x0.3	00.2 x3	00.3 x0.5	00.3 x1.5	00.4 x0.5	00.4 x6	00.5 x1	00.5 x9	00.6 x1	00.6 x8
STAINLESS STEEL		Vc (m/min)	fz	fz	fz	fz	fz	fz	fz	fz	fz	fz
1.1	ferritic/martensitic <850	90	0.019	0.014	0.021	0.017	0.023	0.019	0.024	0.018	0.026	0.022
2.1	austenitic <650	75	0.018	0.013	0.02	0.016	0.022	0.018	0.023	0.017	0.025	0.021
2.2	austenitic <750	70	0.017	0.012	0.019	0.015	0.021	0.017	0.022	0.016	0.024	0.02
3.1	DUPLEX STEEL super austenitic <1100	50	0.014	0.009	0.016	0.012	0.018	0.014	0.019	0.013	0.021	0.017

COPPER		Vc (m/min)	fz	fz	fz	fz	fz	fz	fz	fz	fz	fz
Tungsten Copper (WCu)	<700	120	0.019	0.014	0.021	0.017	0.023	0.019	0.024	0.018	0.026	0.022

STEEL		Vc (m/min)	fz	fz	fz	fz	fz	fz	fz	fz	fz	fz
1.1	unalloyed <500	190	0.019	0.014	0.021	0.017	0.023	0.019	0.024	0.018	0.026	0.022
1.2-1.5	unalloyed <1100	180	0.019	0.014	0.021	0.017	0.023	0.019	0.024	0.018	0.026	0.022
2.1-2.2	low-alloyed <950	170	0.018	0.013	0.02	0.016	0.022	0.018	0.023	0.017	0.025	0.021
2.3-2.4	low-alloyed <1300	150	0.018	0.013	0.02	0.016	0.022	0.018	0.023	0.017	0.025	0.021
3.1-3.2	high-alloyed <1100	150	0.017	0.012	0.019	0.015	0.021	0.017	0.022	0.016	0.024	0.02
3.3	high-alloyed <1400	130	0.014	0.009	0.016	0.012	0.018	0.014	0.019	0.013	0.021	0.017

CASTINGS		Vc (m/min)	fz	fz	fz	fz	fz	fz	fz	fz	fz	fz
1.1-1.2	Grey cast iron <1000	190	0.019	0.014	0.021	0.017	0.023	0.019	0.024	0.018	0.026	0.022
2.1-2.2	Modular cast iron <850	180	0.018	0.013	0.02	0.016	0.022	0.018	0.023	0.017	0.025	0.021
3.1-3.2	Malleable cast iron <800	170	0.018	0.013	0.02	0.016	0.022	0.018	0.023	0.017	0.025	0.021

ADVICE | The values marked in turquoise are side applications!
 Values in the table are the shortest and the longest overhang length (L3) of each dimension;
 Please calculate fz, ap and ae depending on the given values.

Material	Hardness in HRC	Feed (mm/Z)	Dimension																															
			00.8 x2	00.8 x9	01 x2.5	01 x12	01.2 x6	01.2 x12	01.4 x8	01.4 x12	01.5 x3	01.5 x12																						
			<table border="0"> <tr> <td>Infeed in mm</td> <td>ae=0.1xD</td> <td>ae=0.04xD</td> <td>ae=0.1xD</td> <td>ae=0.035xD</td> <td>ae=0.1xD</td> <td>ae=0.05xD</td> <td>ae=0.09xD</td> <td>ae=0.04xD</td> <td>ae=0.1xD</td> <td>ae=0.08xD</td> </tr> <tr> <td>Application</td> <td>ap=0.1xD</td> <td>ap=0.04xD</td> <td>ap=0.1xD</td> <td>ap=0.035xD</td> <td>ap=0.1xD</td> <td>ap=0.05xD</td> <td>ap=0.09xD</td> <td>ap=0.04xD</td> <td>ap=0.1xD</td> <td>ap=0.08xD</td> </tr> </table>										Infeed in mm	ae=0.1xD	ae=0.04xD	ae=0.1xD	ae=0.035xD	ae=0.1xD	ae=0.05xD	ae=0.09xD	ae=0.04xD	ae=0.1xD	ae=0.08xD	Application	ap=0.1xD	ap=0.04xD	ap=0.1xD	ap=0.035xD	ap=0.1xD	ap=0.05xD	ap=0.09xD	ap=0.04xD	ap=0.1xD	ap=0.08xD
Infeed in mm	ae=0.1xD	ae=0.04xD	ae=0.1xD	ae=0.035xD	ae=0.1xD	ae=0.05xD	ae=0.09xD	ae=0.04xD	ae=0.1xD	ae=0.08xD																								
Application	ap=0.1xD	ap=0.04xD	ap=0.1xD	ap=0.035xD	ap=0.1xD	ap=0.05xD	ap=0.09xD	ap=0.04xD	ap=0.1xD	ap=0.08xD																								
			<table border="0"> <tr> <td>Application</td> <td></td> <td></td> <td></td> <td></td> <td></td> <td></td> <td></td> <td></td> <td></td> <td></td> </tr> </table>										Application																					
Application																																		
HARDENED STEEL		Vc (m/min)	fz	fz	fz	fz	fz	fz	fz	fz	fz	fz																						
1.1	46-55	110	0.029	0.025	0.034	0.028	0.036	0.031	0.036	0.031	0.038	0.033																						
1.2	56-60	70	0.028	0.024	0.032	0.026	0.035	0.03	0.035	0.03	0.037	0.032																						
1.3	60-65	50	0.026	0.022	0.03	0.024	0.033	0.028	0.033	0.028	0.035	0.03																						
1.4	66-70	40	0.021	0.017	0.025	0.019	0.028	0.023	0.028	0.023	0.03	0.025																						

Material	Strength (N/mm²)	Feed (mm/Z)	Dimension									
			00.8 x2	00.8 x9	01 x2.5	01 x12	01.2 x6	01.2 x12	01.4 x8	01.4 x12	01.5 x3	01.5 x12
STAINLESS STEEL		Vc (m/min)	fz	fz	fz	fz	fz	fz	fz	fz	fz	fz
1.1	ferritic/martensitic <850	90	0.029	0.025	0.034	0.028	0.036	0.031	0.036	0.031	0.038	0.033
2.1	austenitic <650	75	0.028	0.024	0.032	0.026	0.035	0.03	0.035	0.03	0.037	0.032
2.2	austenitic <750	70	0.026	0.022	0.03	0.024	0.033	0.028	0.033	0.028	0.035	0.03
3.1	DUPLEX STEEL super austenitic <1100	50	0.021	0.017	0.025	0.019	0.028	0.023	0.028	0.023	0.03	0.025

COPPER		Vc (m/min)	fz	fz	fz	fz	fz	fz	fz	fz	fz	fz
Tungsten Copper (WCu)	<700	120	0.029	0.025	0.034	0.028	0.036	0.031	0.036	0.031	0.038	0.033

STEEL		Vc (m/min)	fz	fz	fz	fz	fz	fz	fz	fz	fz	fz
1.1	unalloyed <500	190	0.029	0.025	0.034	0.028	0.036	0.031	0.036	0.031	0.038	0.033
1.2-1.5	unalloyed <1100	180	0.029	0.025	0.034	0.028	0.036	0.031	0.036	0.031	0.038	0.033
2.1-2.2	low-alloyed <950	170	0.028	0.024	0.032	0.026	0.035	0.03	0.035	0.03	0.037	0.032
2.3-2.4	low-alloyed <1300	150	0.028	0.024	0.032	0.026	0.035	0.03	0.035	0.03	0.037	0.032
3.1-3.2	high-alloyed <1100	150	0.026	0.022	0.03	0.024	0.033	0.028	0.033	0.028	0.035	0.03
3.3	high-alloyed <1400	130	0.021	0.017	0.025	0.019	0.028	0.023	0.028	0.023	0.03	0.025

CASTINGS		Vc (m/min)	fz	fz	fz	fz	fz	fz	fz	fz	fz	fz
1.1-1.2	Grey cast iron <1000	190	0.029	0.025	0.034	0.028	0.036	0.031	0.036	0.031	0.038	0.033
2.1-2.2	Modular cast iron <850	180	0.028	0.024	0.032	0.026	0.035	0.03	0.035	0.03	0.037	0.032
3.1-3.2	Malleable cast iron <800	170	0.028	0.024	0.032	0.026	0.035	0.03	0.035	0.03	0.037	0.032

ADVICE | The values marked in turquoise are side applications!
 Values in the table are the shortest and the longest overhang length (L3) of each dimension;
 Please calculate fz, ap and ae depending on the given values.

Dimension	Ø1.6 x8	Ø1.6 x12	Ø1.8 x8	Ø1.8 x12	Ø2 x3	Ø2 x12	Ø2.5 x10	Ø3 x8	Ø3 x16
Infeed in mm	ae=0.1xD ap=0.1xD	ae=0.08xD ap=0.08xD	ae=0.1xD ap=0.1xD	ae=0.09xD ap=0.09xD	ae=0.1xD ap=0.1xD	ae=0.09xD ap=0.09xD	ae=0.1xD ap=0.1xD	ae=0.01xD ap=0.01xD	ae=0.1xD ap=0.1xD
Application									

Material	Hardness in HRC	Feed (mm/Z)	fz									
			fz	fz	fz	fz	fz	fz	fz	fz	fz	
H HARDENED STEEL		Vc (m/min)										
1.1	46-55	110	0.038	0.033	0.04	0.037	0.041	0.038	0.041	0.044	0.041	
1.2	56-60	70	0.037	0.032	0.039	0.036	0.04	0.037	0.04	0.042	0.039	
1.3	60-65	50	0.035	0.03	0.037	0.034	0.038	0.035	0.038	0.04	0.037	
1.4	66-70	40	0.03	0.025	0.032	0.029	0.033	0.03	0.033	0.035	0.032	

Material	Strength (N/mm²)	Feed (mm/Z)	fz									
			fz	fz	fz	fz	fz	fz	fz	fz	fz	
M STAINLESS STEEL		Vc (m/min)										
1.1	ferritic/martensitic <850	90	0.038	0.033	0.04	0.037	0.041	0.038	0.041	0.044	0.041	
2.1	austenitic <650	75	0.037	0.032	0.039	0.036	0.04	0.037	0.04	0.042	0.039	
2.2	austenitic <750	70	0.035	0.03	0.037	0.034	0.038	0.035	0.038	0.04	0.037	
3.1	DUPLEX STEEL super austenitic <1100	50	0.03	0.025	0.032	0.029	0.033	0.03	0.033	0.035	0.032	

Material	Hardness in HRC	Feed (mm/Z)	fz									
			fz	fz	fz	fz	fz	fz	fz	fz	fz	
N COPPER		Vc (m/min)										
Tungsten Copper (WCu)	<700	120	0.038	0.033	0.04	0.037	0.041	0.038	0.041	0.044	0.041	

Material	Hardness in HRC	Feed (mm/Z)	fz									
			fz	fz	fz	fz	fz	fz	fz	fz	fz	
P STEEL		Vc (m/min)										
1.1	unalloyed <500	190	0.038	0.033	0.04	0.037	0.041	0.038	0.041	0.044	0.041	
1.2-1.5	unalloyed <1100	180	0.038	0.033	0.04	0.037	0.041	0.038	0.041	0.044	0.041	
2.1-2.2	low-alloyed <950	170	0.037	0.032	0.039	0.036	0.04	0.037	0.04	0.042	0.039	
2.3-2.4	low-alloyed <1300	150	0.037	0.032	0.039	0.036	0.04	0.037	0.04	0.042	0.039	
3.1-3.2	high-alloyed <1100	150	0.035	0.03	0.037	0.034	0.038	0.035	0.038	0.04	0.037	
3.3	high-alloyed <1400	130	0.03	0.025	0.032	0.029	0.033	0.03	0.033	0.035	0.032	

Material	Hardness in HRC	Feed (mm/Z)	fz									
			fz	fz	fz	fz	fz	fz	fz	fz	fz	
K CASTINGS		Vc (m/min)										
1.1-1.2	Grey cast iron <1000	190	0.038	0.033	0.04	0.037	0.041	0.038	0.041	0.044	0.041	
2.1-2.2	Modular cast iron <850	180	0.037	0.032	0.039	0.036	0.04	0.037	0.04	0.042	0.039	
3.1-3.2	Malleable cast iron <800	170	0.037	0.032	0.039	0.036	0.04	0.037	0.04	0.042	0.039	

ADVICE | The values marked in turquoise are side applications!
 Values in the table are the shortest and the longest overhang length (L3) of each dimension;
 Please calculate fz, ap and ae depending on the given values.

DO YOU HAVE BLUNT MILLING CUTTERS THAT URGENTLY NEED REGRINDING?



→ DISCOVER OUR H&V REGRINDING SERVICE

... and have your tools reconditioned to their original state!



Cooling	
Tolerance	d04
Coating	AlphaDura Navy

Strategy	HSC	
Application		
Features	HA	

- Ultrafine carbide grade developed for machining hardened steels
- Optimized face geometry for long tool life and highest dimensional accuracy
- Reinforced core for milling up to 70 HRC

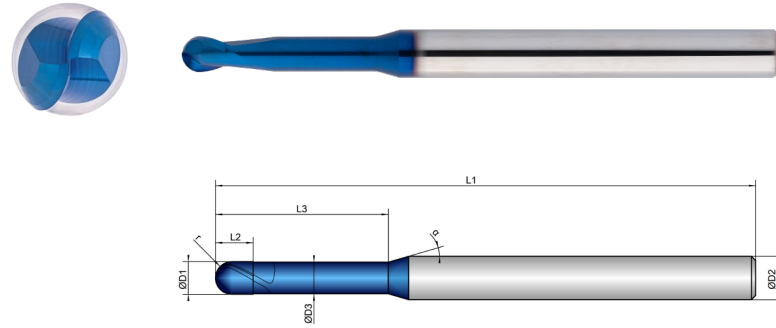

- Tolerance D1: -0.001/-0.006 mm
- Tolerance D3: 0/-0.02 mm
- Radius tolerance r: 0/-0.003 mm (measured from 0-90°)

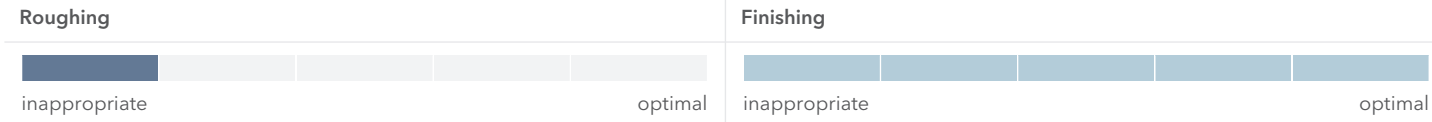

K203212	D1 mm ∅	D3 mm ∅	L2 mm	L3 mm	L1 mm	D2 mm ∅	z #	r mm	°	α °
0,3X1,75	0.3	0.27	0.24	1.75	50.0	4.0	2	0.15	30	16
0,3X2	0.3	0.27	0.24	2.0	50.0	4.0	2	0.15	30	16
0,3X2,25	0.3	0.27	0.24	2.25	50.0	4.0	2	0.15	30	16
0,3X2,5	0.3	0.27	0.24	2.5	50.0	4.0	2	0.15	30	16
0,3X2,75	0.3	0.27	0.24	2.75	50.0	4.0	2	0.15	30	16
0,3X3	0.3	0.27	0.24	3.0	50.0	4.0	2	0.15	30	16
0,3X3,5	0.3	0.27	0.24	3.5	50.0	4.0	2	0.15	30	16
0,3X4	0.3	0.27	0.24	4.0	50.0	4.0	2	0.15	30	16
0,3X4,5	0.3	0.27	0.24	4.5	50.0	4.0	2	0.15	30	16
0,5X10	0.5	0.47	0.4	10.0	50.0	4.0	2	0.25	30	16
0,6X10	0.6	0.57	0.48	10.0	50.0	4.0	2	0.30	30	16
0,6X12	0.6	0.57	0.48	12.0	50.0	4.0	2	0.30	30	16

K203212	D1 mm ∅	D3 mm ∅	L2 mm	L3 mm	L1 mm	D2 mm ∅	z #	r mm	°	α °
0,8X10	0.8	0.77	0.64	10.0	50.0	4.0	2	0.40	30	16
1X14	1.0	0.96	0.8	14.0	50.0	4.0	2	0.50	30	16
1X16	1.0	0.96	0.8	16.0	50.0	4.0	2	0.50	30	16
1,2X14	1.2	1.16	0.96	14.0	50.0	4.0	2	0.60	30	16
1,2X16	1.2	1.16	0.96	16.0	50.0	4.0	2	0.60	30	16
1,4X16	1.4	1.34	1.12	16.0	50.0	4.0	2	0.70	30	16
1,5X14	1.5	1.44	1.2	14.0	50.0	4.0	2	0.75	30	16
1,5X16	1.5	1.44	1.2	16.0	50.0	4.0	2	0.75	30	16
1,6X16	1.6	1.54	1.28	16.0	50.0	4.0	2	0.80	30	16
1,8X16	1.8	1.74	1.44	16.0	50.0	4.0	2	0.90	30	16
2X14	2.0	1.94	1.6	14.0	50.0	4.0	2	1.00	30	16
2X16	2.0	1.94	1.6	16.0	50.0	4.0	2	1.00	30	16
2,5X15	2.5	2.41	2.0	15.0	50.0	4.0	2	1.25	30	16
3X16	3.0	2.92	3.5	16.0	50.0	4.0	2	1.50	30	16

Material	Hardness in HRC	Feed (mm/Z)	Dimension									
			00.3 x1.75	00.3 x4.5	00.5 x10	00.6 x10	00.6 x12	00.8 x10	01 x14	01 x16	01.2 x14	01.2 x16
			Infeed in mm ae= 0.09xD, 0.03xD, 0.01xD, 0.01xD, 0.01xD, 0.035xD, 0.02xD, 0.01xD, 0.035xD, 0.03xD ap= 0.09xD, 0.03xD, 0.01xD, 0.01xD, 0.01xD, 0.035xD, 0.02xD, 0.01xD, 0.035xD, 0.03xD									
			Application 									
			HARDENED STEEL									
			Vc (m/min)									
1.1	46-55	110	fz	fz	fz	fz	fz	fz	fz	fz	fz	fz
1.2	56-60	70	fz	fz	fz	fz	fz	fz	fz	fz	fz	fz
1.3	60-65	50	fz	fz	fz	fz	fz	fz	fz	fz	fz	fz
1.4	66-70	40	fz	fz	fz	fz	fz	fz	fz	fz	fz	fz

Material	Strength (N/mm²)	Feed (mm/Z)	Dimension									
			00.3 x1.75	00.3 x4.5	00.5 x10	00.6 x10	00.6 x12	00.8 x10	01 x14	01 x16	01.2 x14	01.2 x16
			Strength fz, fz, fz, fz, fz, fz, fz, fz, fz, fz, fz, fz									
			STAINLESS STEEL									
			Vc (m/min)									
1.1	ferritic/martensitic <850	90	fz	fz	fz	fz	fz	fz	fz	fz	fz	fz
2.1	austenitic <650	75	fz	fz	fz	fz	fz	fz	fz	fz	fz	fz
2.2	austenitic <750	70	fz	fz	fz	fz	fz	fz	fz	fz	fz	fz
3.1	DUPLEX STEEL super austenitic <1100	50	fz	fz	fz	fz	fz	fz	fz	fz	fz	fz

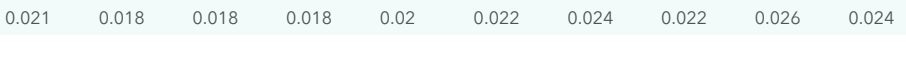
Material	Hardness in HRC	Feed (mm/Z)	Dimension									
			00.3 x1.75	00.3 x4.5	00.5 x10	00.6 x10	00.6 x12	00.8 x10	01 x14	01 x16	01.2 x14	01.2 x16
			Application 									
			COPPER									
			Vc (m/min)									
Tungsten Copper (WCu) <700	<700	120	fz	fz	fz	fz	fz	fz	fz	fz	fz	fz

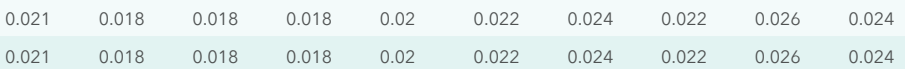
Material	Hardness in HRC	Feed (mm/Z)	Dimension									
			00.3 x1.75	00.3 x4.5	00.5 x10	00.6 x10	00.6 x12	00.8 x10	01 x14	01 x16	01.2 x14	01.2 x16
			Application 									
			STEEL									
			Vc (m/min)									
1.1	unalloyed <500	190	fz	fz	fz	fz	fz	fz	fz	fz	fz	fz
1.2-1.5	unalloyed <1100	180	fz	fz	fz	fz	fz	fz	fz	fz	fz	fz
2.1-2.2	low-alloyed <950	170	fz	fz	fz	fz	fz	fz	fz	fz	fz	fz
2.3-2.4	low-alloyed <1300	150	fz	fz	fz	fz	fz	fz	fz	fz	fz	fz
3.1-3.2	high-alloyed <1100	150	fz	fz	fz	fz	fz	fz	fz	fz	fz	fz
3.3	high-alloyed <1400	130	fz	fz	fz	fz	fz	fz	fz	fz	fz	fz

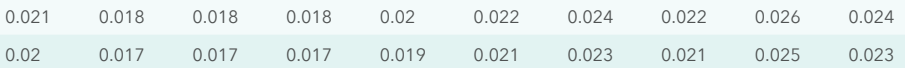
Material	Hardness in HRC	Feed (mm/Z)	Dimension									
			00.3 x1.75	00.3 x4.5	00.5 x10	00.6 x10	00.6 x12	00.8 x10	01 x14	01 x16	01.2 x14	01.2 x16
			Application 									
			CASTINGS									
			Vc (m/min)									
1.1-1.2	Grey cast iron <1000	190	fz	fz	fz	fz	fz	fz	fz	fz	fz	fz
2.1-2.2	Modular cast iron <850	180	fz	fz	fz	fz	fz	fz	fz	fz	fz	fz
3.1-3.2	Malleable cast iron <800	170	fz	fz	fz	fz	fz	fz	fz	fz	fz	fz

ADVICE | The values marked in turquoise are side applications!
 Values in the table are the shortest and the longest overhang length (L3) of each dimension;
 Please calculate fz, ap and ae depending on the given values.

Material	Hardness in HRC	Feed (mm/Z)	Dimension									
			01.4 x16	01.5 x14	01.5 x16	01.6 x16	01.8 x16	02 x14	02 x16	02.5 x15	03 x16	
			Infeed in mm ae= 0.04xD, 0.07xD, 0.05xD, 0.05xD, 0.08xD, 0.09xD, 0.08xD, 0.09xD, 0.09xD, 0.1xD ap= 0.04xD, 0.07xD, 0.05xD, 0.05xD, 0.08xD, 0.09xD, 0.08xD, 0.09xD, 0.09xD, 0.1xD									
			Application 									
			HARDENED STEEL									
			Vc (m/min)									
1.1	46-55	110	fz	fz	fz	fz	fz	fz	fz	fz	fz	fz
1.2	56-60	70	fz	fz	fz	fz	fz	fz	fz	fz	fz	fz
1.3	60-65	50	fz	fz	fz	fz	fz	fz	fz	fz	fz	fz
1.4	66-70	40	fz	fz	fz	fz	fz	fz	fz	fz	fz	fz

Material	Strength (N/mm²)	Feed (mm/Z)	Dimension									
			01.4 x16	01.5 x14	01.5 x16	01.6 x16	01.8 x16	02 x14	02 x16	02.5 x15	03 x16	
			Strength fz, fz, fz, fz, fz, fz, fz, fz, fz, fz, fz, fz									
			STAINLESS STEEL									
			Vc (m/min)									
1.1	ferritic/martensitic <850	90	fz	fz	fz	fz	fz	fz	fz	fz	fz	fz
2.1	austenitic <650	75	fz	fz	fz	fz	fz	fz	fz	fz	fz	fz
2.2	austenitic <750	70	fz	fz	fz	fz	fz	fz	fz	fz	fz	fz
3.1	DUPLEX STEEL super austenitic <1100	50	fz	fz	fz	fz	fz	fz	fz	fz	fz	fz

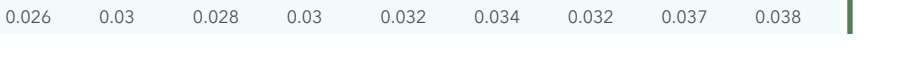
Material	Hardness in HRC	Feed (mm/Z)	Dimension									
			01.4 x16	01.5 x14	01.5 x16	01.6 x16	01.8 x16	02 x14	02 x16	02.5 x15	03 x16	
			Application 									
			COPPER									
			Vc (m/min)									
Tungsten Copper (WCu) <700	<700	120	fz	fz	fz	fz	fz	fz	fz	fz	fz	fz

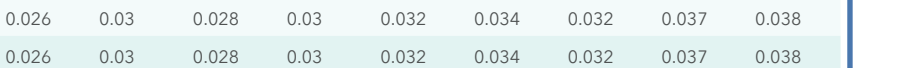
Material	Hardness in HRC	Feed (mm/Z)	Dimension									
			01.4 x16	01.5 x14	01.5 x16	01.6 x16	01.8 x16	02 x14	02 x16	02.5 x15	03 x16	
			Application 									
			STEEL									
			Vc (m/min)									
1.1	unalloyed <500	190	fz	fz	fz	fz	fz	fz	fz	fz	fz	fz
1.2-1.5	unalloyed <1100	180	fz	fz	fz	fz	fz	fz	fz	fz	fz	fz
2.1-2.2	low-alloyed <950	170	fz	fz	fz	fz	fz	fz	fz	fz	fz	fz
2.3-2.4	low-alloyed <1300	150	fz	fz	fz	fz	fz	fz	fz	fz	fz	fz
3.1-3.2	high-alloyed <1100	150	fz	fz	fz	fz	fz	fz	fz	fz	fz	fz
3.3	high-alloyed <1400	130	fz	fz	fz	fz	fz	fz	fz	fz	fz	fz

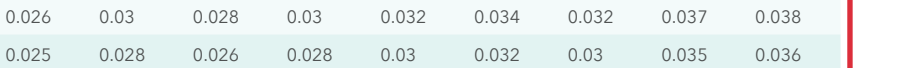
Material	Hardness in HRC	Feed (mm/Z)	Dimension									
			01.4 x16	01.5 x14	01.5 x16	01.6 x16	01.8 x16	02 x14	02 x16	02.5 x15	03 x16	
			Application 									
			CASTINGS									
			Vc (m/min)									
1.1-1.2	Grey cast iron <1000	190	fz	fz	fz	fz	fz	fz	fz	fz	fz	fz
2.1-2.2	Modular cast iron <850	180	fz	fz	fz	fz	fz	fz	fz	fz	fz	fz
3.1-3.2	Malleable cast iron <800	170	fz	fz	fz	fz	fz	fz	fz	fz	fz	fz

ADVICE | The values marked in turquoise are side applications!
 Values in the table are the shortest and the longest overhang length (L3) of each dimension;
 Please calculate fz, ap and ae depending on the given values.

EXPLANATION

APPLICATIONS

Multipass milling	Trimming	Deburring	Engraving
Corner rounding	Full slot milling	Forward and backward deburring	

COOLINGS

Air-cooling	Dry machining	Oil cooling	Cooling Lubricant
Minimum quantity lubrication			

FEATURES

0,5xD	1xD	1,5xD	2xD
2,5xD	3xD	3,5xD	4xD
5xD	Center cutting	Non-center cutting	Without Weldon
With Weldon	Internal cooling	Dynamic helical pitch	Chip breaker
Unequal tooth pitch	Roughing teeth	Helical immersion	Feed directions x,y
Feed directions x, y, z	Feed directions x, y, (z)	Corner radius	Corner bevel
Sharp edged	60° Tip	90° Tip	140° Tip

STRATEGY

Extended Trochoidal Cutting	High Performance Cutting	High Speed Cutting	Multi Task Cutting
Universal Machining			

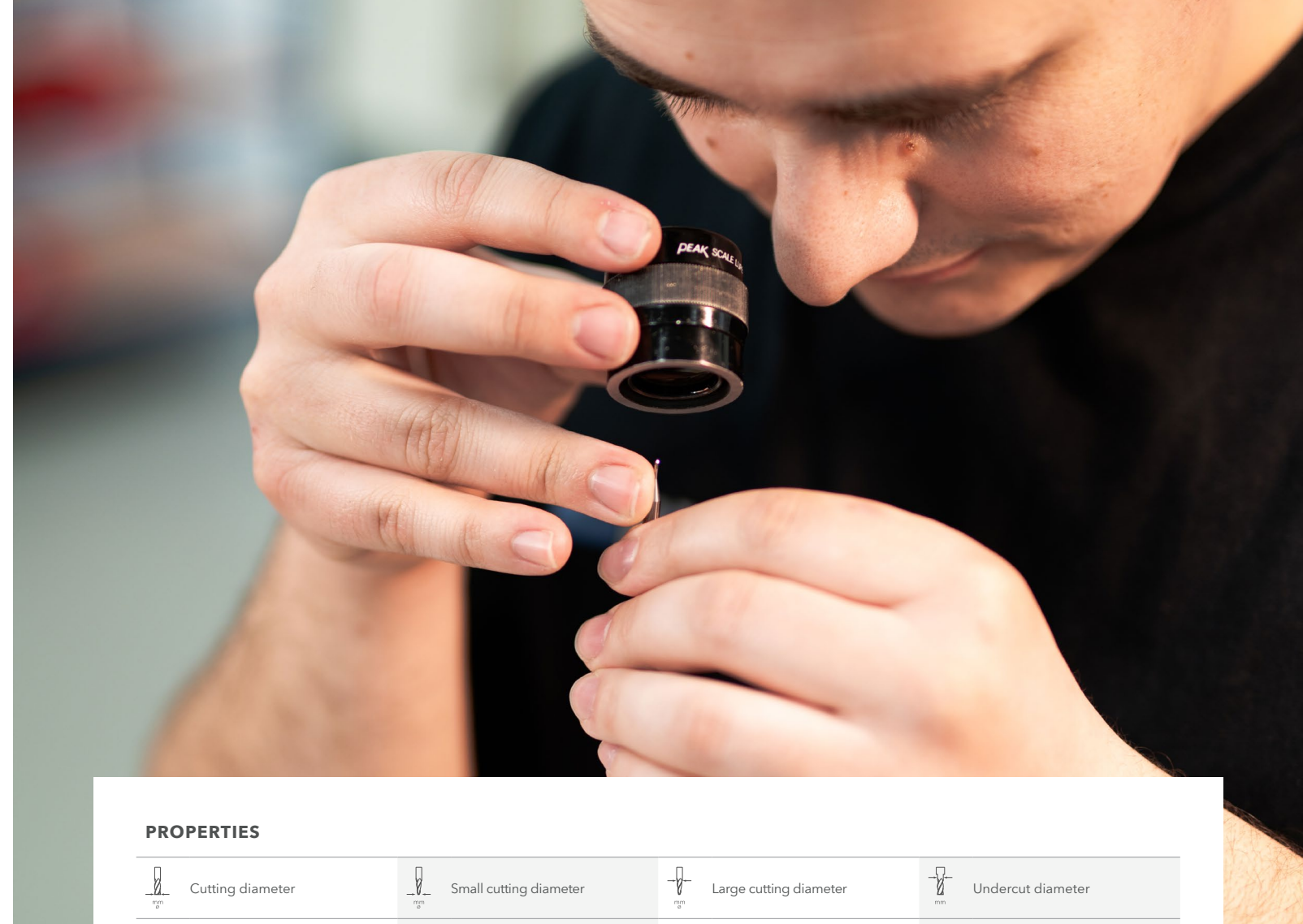

PROPERTIES

Cutting diameter	Small cutting diameter	Large cutting diameter	Undercut diameter
Cutting length	Total bevel length	Undercut length	Total length
Shank diameter	Number of teeth	Corner radius	Corner bevel
Programming radius	Maximum cutting depth	Helical angle	Alpha angle

APPLICATION TABLE

The values given in the application table are only guidelines. These values are largely dependent on the machining situation and application.

FIGURES

All technical drawings and photographs are given as an example. The product may deviate from the original in terms of colour and dimensions.

H 1.1-1.4 **HARDENED STEEL | 46-70 HRC**

Materialnumber	Germany DIN	Europe EN	France AFNOR	Great Britain BS	Italy UNI	Sweden SIS	Spain UNE	Japan JIS	USA AISI
1.2311	40CrMnMo7			BP 20	35 CrMo 8 KU				P 20
1.2312	40CrMnMoS86		40 CMD 8						
1.2316	X36CrMo17	X 36 CrMo 17	X38CrMo 16 1		X 38 CrMo 16 1 KU		X 38 CrMo 16		D-4
1.2365	X32CrMoV33	X 32CrMoV 12 28	32 DCV 28	BH 10	30 CrMoV 12 27 KU		F.5313	SKD 7	H 10
1.2567	X30WCrV53	X 30 WCrV 5 3	Z 32 WCV 5		X 30 WCrV 5 3 KU			SKD 4	
1.2581	X30WCrV93	X 30 WCrV 9 3	Z 30 WCV 9	BH 21	X 30 WCrV 9 3 KU		X 30 WCrV 9	SKD 5	H 21
1.2738	40CrMnNiMo864		40 CMND 8				F.5303		
1.2885	X32CrMoCoV333		30 DCKV 28						
1.4028	X30Cr13	X 30 Cr 13	Z 30 Cr 13	420 S 45	X 30 Cr 13	2304	X 30 Cr 13	SUS 420 J2	420
1.4031	X40Cr13	X 40 Cr 13	Z 40 C 14		X 40 Cr 14	2304	X 40 Cr 13	SUS 420	420
1.4034	X45Cr13	X 45 Cr 13	Z 40 C 14	420 S 45	X 40 Cr 14		X 46 Cr 13		420
1.4112	X90CrMoV18	X 90 CrMoV 18	Z 3 CT 1 2	409 S 1 9	X 6 Cr Ti 1 2			SUS 440 B	440 B
1.5122	37 MnSi 4		38 MS 5						
1.6358	X2NiCoMoTi 1895								
1.6582	34CrNiMo6		35 NCD 6	817 M 40	35 NiCrMo 6 (KW)	2541	F.1270	SNCM 447	4340
1.7003	38 Cr 2		38 C 2	120 M 36	38 Cr 2		F.1200		
1.7006	46 Cr 2		45 C 2		4 5Cr 2				5045
1.7030	28 Cr 4			530 A 30					5130
1.7176	55 Cr 3		55 C 3	525 A 58	55 Cr 3	2253	F.1431	SUP 9	5155
1.0961	60SiCr7	60 SiCr 8	60 SC 7	250 A 61	60 SiCr 8		60 SiCr 8	SUP 7	9262
1.1248	Ck 75		XC 75	060 A 78		1774			1078
1.1273	90Mn4			060 A 96				SUP 4	1090
1.2083	X42Cr13	X 42 Cr 13	Z 40 C 14		X 41 Cr 13 KU	2314		SUS 420 J2	420
1.2323	48CrMoV67		45 CDV 6						
1.2343	X38CrMoVH1	X 38 CrMoV 5 1	Z 38 CDV 5	BH 11	X 37 CrMoV 5 1 KU		X 37 CrMoV 5	SKD 6	H 11
1.2367	X38CrMoV53		Z 38 CDV 5 3						
1.2510	100 MnCrW 4		90 MWCV 5	B0 1	95 MnWCr 5 KU	2140	F.5220	SKS 3	0 1
1.2542	45WCrV7	45 WCrV 8		BS 1	45 WCrV 8 KU	2710	45 WCrSi 8		S1
1.2550	60 WCrV 7		55 WC 20		55 WCrV 8 KU				
1.2606	X37CrMoW51		Z 35 CWDV 5	BH 12	X 35 CrMoW 05 KU		F.537	SKD 62	H 12
1.2711	54 NiCrMoV		55 NCDV 6						
1.2713	55 NiCrMoV 6		55 NCDV 7				F.520.S	SKT 4	L 6
1.2764	X19NiCrMo4								
1.2767	X45NiCrMo4	40 NiCrMo 4	Y 35 NCD 16		42 NiCrMo 15 7 KU				A 9
1.4109	X65CrMo14	X 70 CrMo 15	Z 70 CD 14					SUS 440 A	440 A
1.1157	40Mn4		35 M 5	150 M 36					1039
1.1231	Ck 67		XC 68	060 A 67	C 70	1770			1070
1.1274	Ck 101		XC 100	060 A 96		1870		SUP 4	1095
1.2080	X210Cr12		Z 200 C 12		X 210 Cr 13 KU			SKD 1	D 3
1.2101	62SiMnCr4								
1.2162	21MnCr5	21 MnCr 5	20 NC 5					SCR 420 H	
1.2201	X165CrV12								
1.2210	115CrV3	107 CrV 3 KU	100 C 3		107 CrV 3 KU		F.520.L		L2
1.2341	X6CrMo4								
1.2379	X155CrVMo121	X 153 CrMoV 12	Z 160 CDV 12	BD 2	X 155 CrVMo 12 1 KU	2310		SKD 11	D 2
1.2419	105WCr6	105 WCr 5	105 WC 13		107 WCr 5 KU	2140	105 WCr 5	SKS 31	
1.2601	X165CrMoV12	X 165 CrMoV 12			X 165 CrMoW 12 KU	2310	X 160 CrMoV 12		
1.2721	50NiCr13								
1.2735	15NiCr14		10 NC 12					SNC 22	
1.2833	100V1		Y1 105 V	BW 2	102 V 2 KU			SKS 43	W 210
1.2842	90MnCrV8	90 MnV 8	90 MV 8	BO 2	90 MnVCr 8 KU				0 2
1.3505	100Cr6		100 C 6	534 A 99	100 Cr 6	2258	F.1310	SUJ 2	52100
1.4125	X105CrMo17		Z 100 CD 17		X 105 CrMo 17			SUS 440 C	440 C
1.8161	58CrV4								
1.1520	C70W1								
1.2363	X100CrMoV51	X 100 CrMoV 5 1	Z 100 CDV 5	BA 2	X 100 CrMoV 5 1 KU	2260	X 100 CrMoV 5	SKD 12	A 2
1.2436	X210CrW12	X 210 CrW 12	Z 210 CW 1 2		X 215 CrW 12 1 KU	2312	X 210 CrW 12	SKD 2	
1.2880	X165CrCoMo12								
1.3202	S12145	HS12-1-5-5		BT 15	HS 12-1-5-5		12-1-5-5		T 15
1.3207	S104310	HS10-4-3-10	Z130WKCDV10-10-04-04	BT 42	HS 10-4-3-10		10-4-3-10	SKH 57	M 44
1.3243	S6525	HS6-5-2-5	KCV 06-05-05-04-02		HS 6-5-2-5	2723	6-5-2-5	SKH 55	M 35
1.3246	S7425	HS1-8-1	Z110WKCDV 07-05-04	T 11341	HS 7-4-2-5		7-4-2-5		M 41
1.3247	S21018	HS2-9-1-8	Z110 DKCWV 09-08-04	BM 42	HS 2-9-1-8		2-10-1-8		M 42
1.3249	S2928			BM 34			2-9-2-8		

Materialnumber	Germany DIN	Europe EN	France AFNOR	Great Britain BS	Italy UNI	Sweden SIS	Spain UNE	Japan JIS	USA AISI
1.3257	S181215								
1.3333	S332	HS 3-3-2							
1.3343	S652	HS6-5-3	Z85 WDCV 06-05-04-02	BM 2			HS 6-5-2		
1.3344	S653		Z120 WDCV 06-05-04-03						
1.3346	S291	HS1-8-1	Z85 DCWW 08-04-02-01	BM 1			HS 1-8-1		
1.3348	S292	HS2-9-2	Z100 DCWW 09-04-02-02				HS 2-9-2		M 7
1.3355	S1801	HS18-0-1	Z80 WCV 18-04-01	BT 1			HS 18-0-1		
1.1654	C 110 W								

Technical formulas

Calculate cutting speed (m/min)

$$V_c = \frac{D * \pi * n}{1000}$$

Explanation of terms

Vc Cutting speed in m/min

Calculate rotational speed (rpm)

$$n = \frac{V_c * 1000}{D * \pi}$$

n Rotational speed in rpm

Calculate feed rate (mm/min)

$$V_f = n * z * f_z$$

Vf Feed rate in mm/min

Calculate feed per tooth (mm/number of teeth)

$$f_z = \frac{V_f}{n * z}$$

Fz Feed per tooth in mm/number of teeth

Calculate chip removal rate (cm³/min)

$$Q = \frac{a_p * a_e * V_f}{1000}$$

z Number of teeth (cutting)

ap Depth of cut in mm

ae Width of cut in mm

hm Average chip thickness in mm

Q Chip removal rate in cm³/min

Calculate average chip thickness (mm)

$$h_m = f_z * \sqrt{\frac{a_e}{D}}$$

D Diameter of tool in mm

GENERAL TERMS OF SALE

§ 1 SCOPE

1. These General Terms of Sale apply to all business relationships between Hofmann & Vratny OHG (hereinafter referred to as “Hofmann & Vratny”) and its customers (hereinafter referred to individually as the “Ordering Party” and collectively as the “Ordering Parties”).

2. These General Terms of Sale only apply to Ordering Parties that are entrepreneurs pursuant to §§ 14 and 310 para. 1 of the BGB (Civil Code of Germany), legal entities under public law, and/or special funds under public law.

3. The scope of application of these General Terms of Sale includes, but is not limited to, contracts regarding the sale and/or delivery of chattels (hereinafter referred to as “Goods”) regardless of whether they are produced by Hofmann & Vratny or procured from suppliers (§§ 433 and 651 of the BGB). Unless agreed upon otherwise, the version of these General Terms of Sale applicable at the time the Ordering Party places an order and in any case the most recent version of these General Terms of Sale provided to the Ordering Party in writing in the form of a master agreement also shall apply to similar contracts made at a later date without Hofmann & Vratny being required to make reference to them in every individual case.

4. These General Terms of Sale shall apply exclusively. These General Terms of Sale also shall apply if and when Hofmann & Vratny executes a delivery without reservation despite having knowledge of the Ordering Party’s terms of sale which contradict or deviate from these General Terms of Sale. Any of the Ordering Party’s terms of sale which contradict or deviate from these General Terms of Sale shall become part of a contract only with Hofmann & Vratny’s express prior consent. Such requirement to consent shall apply in any case even, for example, if the Ordering Party refers to its terms of sale as part of an order placement and Hofmann & Vratny does not object explicitly to such terms.

5. If Hofmann & Vratny and the Ordering Party have entered into any individual agreements, such individual agreements shall prevail over these General Terms of Sale. The content of such individual agreements only can be substantiated by a written contract or by written confirmation from Hofmann & Vratny. Individual agreements (e.g., outline delivery contracts, quality assurance agreements) and information provided in Hofmann & Vratny’s order confirmation shall prevail over these General Terms of Sale. In case of doubt, commercial clauses shall be interpreted based on the Incoterms® issued by the International Chamber of Commerce in Paris (ICC) and applicable at the time the contract is entered into.

6. All of the Ordering Party’s legal declarations and notifications made with regard to the contract (e.g., in connection with deadlines or notices of defects, rescission, or reduction) shall be made in writing to be effective. In the context of these General Terms of Sale, in writing shall include written and text forms (e.g., letters, e-mails, faxes). Legal requirements regarding form and other verifications including, but not limited to, cases of doubt regarding the legitimation of the notifying party shall remain unaffected.

7. All references to applicable laws shall be for the purpose of clarification only. Unless amended in or excluded expressly from these General Terms of Sale, laws shall apply even without express reference.

§ 2 OFFERS AND ACCEPTANCE

1. All offers made by Hofmann & Vratny shall be subject to change and shall be non-binding including if and when images, drawings, technical documentation, calculations, analyses, other documents or product descriptions of whatever nature (hereinafter referred to as “Documents”) are provided to the Ordering Party if the proprietary rights and copyrights to those Documents are retained by Hofmann & Vratny.

2. All orders for Goods placed by the Ordering Party shall constitute binding offers. Unless stated otherwise in the respective order, Hofmann & Vratny shall be entitled to accept an offer within two weeks after receipt of said offer.

3. Hofmann & Vratny shall accept offers in writing (e.g., in the form of an order confirmation) or by delivering the respective Goods to the Ordering Party.

4. All proprietary rights and copyrights to Documents shall remain with Hofmann & Vratny. Documents marked as confidential shall be forwarded to third parties only with the express written consent of Hofmann & Vratny.

§ 3 DELIVERY DEADLINES AND DEFAULT OF DELIVERY

1. Delivery deadlines shall be agreed upon by Hofmann & Vratny and the individual Ordering Party or shall be specified by Hofmann & Vratny upon acceptance of the order or in the order confirmation.

2. Hofmann & Vratny’s compliance with delivery obligations shall be conditional upon the Ordering Party’s on-time and proper compliance with the Ordering Party’s obligations including, but not limited to, the provision of the papers, permits and approvals required to be provided by the Ordering Party and the receipt by Hofmann & Vratny of the agreed-upon down payment, if any. In the event of delays, the delivery time shall be extended reasonably.

3. If Hofmann & Vratny is unable to meet any binding delivery deadlines for reasons beyond the control of Hofmann & Vratny (non-availability of services), the Ordering Party shall be notified without undue delay and shall be provided with an estimated new delivery deadline. If the agreed upon Goods do not become available before the new deadline expires, Hofmann & Vratny shall be entitled to rescind the contract in whole or in part and shall reimburse the Ordering Party without undue delay for any and all consideration paid up to that time. For the fulfillment of this clause, non-availability of services shall include, but shall not be limited to, delayed delivery from any of Hofmann & Vratny’s suppliers for reasons beyond the control of Hofmann & Vratny or its suppliers, or if Hofmann & Vratny is not responsible for procuring the Goods.

4. If failure to comply with a delivery deadline is due to an act of God, industrial dispute or other event beyond the control of Hofmann & Vratny, the delivery time shall be extended reasonably. The same shall apply if and when any such act of God, industrial dispute or other event has arisen at any of Hofmann & Vratny’s sub-suppliers which event can be demonstrated to have had an impact on compliance with the delivery deadline. Hofmann & Vratny shall notify the Ordering Party of such circumstances without undue delay. Events also shall be deemed to be beyond Hofmann & Vratny’s control if and when they occur during a delay. In this case, the delay shall be deemed to be suspended for the duration of the respective event.

5. The beginning of a period of delivery default shall be in accordance with the law, but shall in any case require a reminder issued by the Ordering Party.

6. If a contract regarding stand-by delivery has been signed, Hofmann & Vratny shall deliver and invoice the Goods no later than 12 months after the date of such contract (hereinafter referred to as the “Recall Period”), even if the Ordering Party has failed to recall the Goods by that time. After the Recall Period has expired, Hofmann & Vratny can notify the Ordering Party of Hofmann & Vratny’s readiness to deliver and can request that the Ordering Party recall the Goods within a reasonable period of time. If the Ordering Party fails to recall the Goods within such period, Hofmann & Vratny shall be entitled to demand an additional lumpsum compensation for warehousing costs (hereinafter referred to as the “Warehousing Allowance”). The Warehousing Allowance shall be 0.5% of the net value of the purchased Goods for every full week, but shall not exceed 5% of the net value of the purchased Goods in total. The Ordering Party shall be free to prove that Hofmann & Vratny did not incur any damages or that any damages incurred were lower than the Warehousing Allowance. If the Ordering Party fails to recall the Goods within the Recall Period determined by Hofmann & Vratny, Hofmann & Vratny shall be entitled to dispose of the Goods as Hofmann & Vratny sees fit. The statutory provisions regarding rescission shall remain unaffected.

§ 4 DELIVERY AND DEFAULT OF ACCEPTANCE

1. Unless agreed upon otherwise, all deliveries shall be ex works, that is, the

place of performance for deliveries and for all subsequent actions. Unless agreed upon otherwise, upon request and at the expense of the Ordering Party the Goods shall be delivered to another destination (hereinafter referred to as “Sales Involving the Carriage of Goods”). Unless agreed upon otherwise, Hofmann & Vratny shall be entitled to determine the shipment method (including, but not limited to, the forwarder, the type of shipment and the packaging).

2. Partial deliveries shall be admissible, provided the Ordering Party reasonably can be expected to accept them.

3. Delivered Goods shall be accepted by the Ordering Party even if the delivered Goods have minor defects provided the Ordering Party reasonably can be expected to accept such Goods.

4. The risk of accidental destruction and/or deterioration of the Goods shall transfer to the Ordering Party no later than upon surrender of the Goods. In the case of Sales Involving the Carriage of Goods, the risk of accidental destruction and/or deterioration of the Goods and the risk of delay shall transfer to the Ordering Party no later than at the time of delivery of the Goods to the forwarder, carrier, or any other person designated to execute shipment of the Goods. Delivery shall be deemed to have been effected even if the Ordering Party is in default of acceptance.

5. If the Ordering Party is in default of acceptance or fails to cooperate or if delivery is delayed for other reasons for which the Ordering Party is responsible, Hofmann & Vratny shall be entitled to demand reimbursement for the damages incurred in connection therewith including additional expenses (e.g., warehousing costs).

§ 5 TERMS OF PAYMENT

1. Unless agreed upon otherwise in individual cases, Hofmann & Vratny’s prices plus statutory sales tax valid at the time the contract is signed shall apply. The prices indicated in Hofmann & Vratny’s catalogs are non-binding and subject to change and/ or correction.

2. Unless agreed upon otherwise, in the case of Sales Involving the Carriage of Goods the Ordering Party shall bear the costs of packaging and transportation ex works and the costs, if any, for transportation insurance if such insurance is requested by the Ordering Party. All customs and other fees, taxes and other public charges also shall be borne by the Ordering Party unless agreed upon otherwise. Ownership of the packaging for transportation and otherwise pursuant to the Verpackungsordnung (Packaging Ordinance of Germany) shall transfer to the Ordering Party and such packaging shall not be returned to Hofmann & Vratny. Pallets shall be exempt from this rule.

3. Unless agreed upon otherwise in the order confirmation, the purchase price plus statutory sales tax shall be due and payable without any deductions within 14 days after the date of invoicing and delivery or acceptance of the Goods. However, Hofmann & Vratny reserves the right to make full or partial deliveries against cash in advance at any time including during an ongoing business relationship. The assertion of such right shall be communicated no later than at the time the order confirmation is issued. The Ordering Party shall be deemed to be in default of payment upon the expiration of the aforementioned payment deadline. The applicable rate of interest on the purchase price of the Goods shall become payable during the default period. The right to assert claims for more substantial compensation shall be reserved. Hofmann & Vratny’s right to claim commercial-rate default interest (§ 353 of the HGB) shall remain unaffected.

4. The Ordering Party’s rights of set-off and retention shall be limited to the extent the Ordering Party’s claim is determined in a court of law or is undisputed. The Ordering Party’s rights based on defects in the purchased Goods (see § 7 hereof) shall remain unaffected.

5. After the contract has been signed, if there is evidence that Hofmann & Vratny’s claim to the purchase price will be compromised due to lack of performance on the part of the Ordering Party, Hofmann & Vratny shall be entitled to refuse performance pursuant to the applicable laws and, after setting a deadline, if applicable, shall be entitled to rescind the contract. In the case of contracts regarding the production of customized items, Hofmann & Vratny shall be entitled to rescind the contract immediately and the laws regarding the expendability of setting deadlines shall remain unaffected.

§ 6 RETENTION OF TITLE

1. Until all pending and future receivables in connection with the business relationship between Hofmann & Vratny and the Ordering Party are paid in full, Hofmann & Vratny shall retain ownership of the Goods. If the Ordering Party violates the contract including, but not limited to, default of payment, Hofmann & Vratny shall be entitled to rescind the contract pursuant to the applicable laws and to demand the surrender of the Goods.

2. Goods subject to retention of title shall not be pledged or assigned as collateral before the Ordering Party has paid in full. The Ordering Party shall notify Hofmann & Vratny in writing without undue delay in the event of a filing for commencement of insolvency proceedings or if third parties gain access (e.g., seizures) to Goods belonging to Hofmann & Vratny.

3. If the Ordering Party violates the contract including, but not limited to, by failing to pay the purchase price when due, Hofmann & Vratny shall be entitled to rescind the contract pursuant to the applicable laws and to demand the surrender of the Goods due to the retention of title and the rescission.

4. Until further notice, the Ordering Party shall be entitled to resell/and or process in the ordinary course of business any Goods subject to retention of title. In this case, the provisions below also shall apply.

a) The retention of title shall include title to the full value of work products resulting from processing, mixing or combining the Goods, in which case Hofmann & Vratny shall be deemed to be the manufacturer. If and when third-party goods are processed, mixed or combined and such third parties retain ownership, Hofmann & Vratny shall acquire coownership pro rata of the invoiced value of work products so processed, mixed or combined. In all other cases, the creation of work products shall be subject to the same provisions as the delivered Goods subject to retention of title.

b) The Ordering Party hereby agrees to assign to Hofmann & Vratny as collateral any and all receivables against third parties resulting from the resale of the Goods or work results in full or in the amount of Hofmann & Vratny’s estimated share of co-ownership pursuant to a) above, and Hofmann & Vratny hereby accepts such assignment. The Ordering Party’s obligations under § 6 2) hereof also shall apply with respect to the receivables assigned.

c) In addition to Hofmann & Vratny, the Ordering Party shall remain authorized to collect receivables. Hofmann & Vratny undertakes to refrain from collecting receivables as long as the Ordering Party meets its payment obligations vis-à-vis Hofmann & Vratny and does not fail to perform and Hofmann & Vratny does not assert its retention of title by asserting a right under § 6 3) hereof. Otherwise, Hofmann & Vratny shall be entitled to demand that the Ordering Party inform Hofmann & Vratny of such receivables assigned and of the names of the debtors, provide Hofmann & Vratny with all the information required for collecting such receivables and the pertinent documents, and inform the debtors (third parties) of the assignment. In addition, in this case Hofmann & Vratny shall be entitled to revoke the Ordering Party’s authorization to resell and/or process Goods which are subject to retention of title.

5. Upon request of the Ordering Party, Hofmann & Vratny shall release the collateral to which Hofmann & Vratny is entitled insofar as the realizable value of such collateral exceeds the receivables to be collateralized by more than 10 percent. Hofmann & Vratny shall be free in its decision regarding which collateral to release.

§ 7 LIABILITY FOR DEFECTS AND CLAIMS FOR DEFECTS

1. Unless otherwise agreed upon herein, the Ordering Party’s rights based on defects in quality and/or in title (including delivery of the wrong Goods or insufficient amounts, improper assembly/installation, or incomplete instructions) shall be subject to the applicable laws. The special legal stipulations regarding reimbursement of expenses at the time of delivery of newly produced Goods (supplier’s recourse as specified in §§ 478, 445a, 445b and §§ 445c, 327 para. 5, 327u of the BGB) shall remain unaffected in any case, unless equal-value compensation has been agreed upon, for example, as part of a quality assurance agreement.

2. Hofmann & Vratny’s liability for defects shall be based first and foremost on the respective agreement entered into regarding the quality and the postulated use of the Goods (including fittings and instructions). In this context,

an agreement regarding the quality of Goods shall be any and all product descriptions and manufacturer-provided information outlined in the individual agreement or made publicly known by Hofmann & Vratny (including, but not limited to, in catalogs or on Hofmann & Vratny's internet homepage) at the time the contract was signed. However, if and when no agreement regarding quality has been entered into, the presence or absence of a defect shall be determined based on the legal regulations (§ 434 para. 3 of the BGB). Statements made publicly by the manufacturer or on the manufacturer's behalf including, but not limited to, in advertising materials or on labels on the Goods shall prevail over other third parties' statements. In the case of Goods comprising digital elements or other digital content, Hofmann & Vratny shall be responsible for providing and, if required, updating the digital content only if defined expressly in an agreement regarding the quality of Goods, as stipulated above. Hofmann & Vratny shall not assume any liability for public statements made by the manufacturer or other third parties.

3. Hofmann & Vratny shall not assume liability for any defects of which the Ordering Party is aware, or for any defects of which the Ordering Party is grossly negligent if it is not aware (§ 442 of the BGB) at time the contract is signed. The assertion of claims by the Ordering Party regarding defects shall be conditional upon the Ordering Party's meeting of its statutory duty to inspect and to give notice of defects (§§ 377 and 381 of the HGB (Commercial Code of Germany)). If a defect in the Goods becomes apparent during or after inspection, the Ordering Party shall give written notice to Hofmann & Vratny without undue delay. Regardless of the Ordering Party's duty to inspect and to give notice of defects, the Ordering Party shall give written notice of obvious defects within two weeks after delivery, which notice shall be deemed to have been given in a timely manner if it is transmitted before the end of such period. If the Ordering Party fails to inspect the Goods properly and/or to give proper notice of any defects, Hofmann & Vratny shall not assume liability for any defects for which no notice was given.

4. If any of the Goods are defective, Hofmann & Vratny shall be free to offer supplementary action to remedy the defect or defects (supplementary remedy) or to deliver defect-free Goods (replacement) to the Ordering Party. In individual cases, the Ordering Party may refuse a supplementary action selected by Hofmann & Vratny that the Ordering Party considers to be unreasonable. It is Hofmann & Vratny's right to refuse to offer supplementary action under the applicable laws shall remain unaffected. The requirement for Hofmann & Vratny to provide any supplementary action owed shall be conditional upon the Ordering Party's paying of the purchase price when due. However, the Ordering Party shall be entitled to retain a reasonable portion of the purchase price pro rata in consideration of the defect. The Ordering Party shall give Hofmann & Vratny the time and the opportunity to provide the supplementary action owed including, but not limited to, providing Hofmann & Vratny the opportunity to inspect the Goods which are subject to complaint. If Hofmann & Vratny opts to replace the Goods, at Hofmann & Vratny's request the Ordering Party shall return the defective Goods to Hofmann & Vratny in accordance with the applicable laws; however, the Ordering Party shall not have the right to request to return the defective Goods. Supplementary action shall not include the disassembly, removal, or de-installation of defective Goods nor the assembly, mounting, or installation of defect-free Goods, provided Hofmann & Vratny was not originally obligated to provide such services; any rights the Ordering Party may have to be reimbursed for such costs (hereinafter referred to as "Disassembly and Assembly Costs") shall remain unaffected.

5. If in fact a defect is present, any and all expenses incurred in connection with inspections and supplementary action including, but not limited to, transportation, road, labor and material costs, and Disassembly and Assembly Costs shall be borne by Hofmann & Vratny in accordance with the laws and these General Terms of Sale. However, if the Ordering Party's demand for remedy of a defect is proven to be invalid because the Ordering Party was aware or was grossly negligent if it was not aware that no defect actually was present, Hofmann & Vratny can demand reimbursement from the Ordering Party for any costs incurred therewith. If the costs of supplementary remedy would be disproportionately high, the Ordering Party shall not be entitled to claim remedy of defects.

6. If and when a reasonable deadline for supplementary action set by the buyer has expired unsuccessfully or can be disregarded under the law, the Ordering Party can rescind the purchasing contract in accordance with the law or reduce the purchase price. However, no right to rescind shall apply in the case of insignificant defects.

7. The Ordering Party's claims for damages or reimbursement for wasted expenses shall be limited by the provisions of § 8 below and shall be excluded in all other cases.

8. The statute of limitations for claims for defects in quality and in title shall be one year after delivery of the Goods. The statute of limitations shall commence upon delivery of the Goods provided acceptance has been agreed upon. Other special legal stipulations regarding statutes of limitations (including, but not limited to, § 438 para. 1 no. 1, no. 2, para. 3, §§ 444, 445b of the BGB) shall remain unaffected. The aforementioned statutes of limitations specified in the purchasing laws also shall apply to any contractual and extra-contractual claims for reimbursement made by the Ordering Party based on a defect in the Goods, unless applying the regular statute of limitations stipulated by law (§§ 195, 199 of the BGB) would result in a reduced statute of limitations in individual cases. Any claims for reimbursement the Ordering Party may have pursuant to § 8 para. 2 p. 1 and p. 2 (a) and pursuant to the Produkthaftungsgesetz (Product Liability Act of Germany) shall be subject exclusively to the statutes of limitations stipulated by law.

§ 8 OTHER LIABILITIES

1. Unless agreed upon otherwise in these General Terms of Sale and in the provisions below, Hofmann & Vratny's liability for breach of contractual and non-contractual obligations shall be in accordance with the applicable laws.

2. Hofmann & Vratny's liability for damages, regardless of the legal reasons and of whether or not they are known, as part of Verschuldenshaftung (liability arising from damage caused by negligent act) shall include intent and gross negligence. Subject to the limitations of liability stipulated by law (e.g., diligence with its own affairs, insignificant breach of duty), in the event of minor negligence Hofmann & Vratny's liability shall be limited to (a) damages resulting from harm to life, body or health and/or (b) damages resulting from the not-insignificant breach of a material contractual obligation, that is, an obligation which must be met to make the proper fulfillment of the contract possible and the meeting of which the Ordering Party relies upon and can rely upon on a regular basis. In this case, however, Hofmann & Vratny's liability shall be limited to reimbursement of the foreseeable damages typical in such cases.

3. The limitation of liability specified above also shall apply vis-à-vis third parties and in the event of a breach of duty by any person (including to his/her own benefit) for which Hofmann & Vratny is responsible by law; however, it shall not apply if and when Hofmann & Vratny is found to have failed to disclose a defect maliciously or has assumed a guarantee for the quality of the Goods and for the Ordering Party's claims under the Produkthaftungsgesetz.

4. The Ordering Party can rescind or cancel a contract due to a breach of obligation other than a breach based on a defect only if and when Hofmann & Vratny is responsible for such breach of obligation. The Ordering Party shall not have an unrestricted right to terminate a contract. All other cases shall be subject to the applicable laws and legal consequences.

§ 9 APPLICABLE LAW AND JURISDICTION

1. These General Terms of Sale and all legal relationships between Hofmann & Vratny and the Ordering Party shall be subject to the laws of the Federal Republic of Germany under exclusion of the provisions of uniform international law. The CISG shall not apply.

2. Any and all disputes arising directly or indirectly from the contractual relationship shall be subject exclusively, including at an international level, to the jurisdiction of Aßling if the Ordering Party is a businessperson as defined in the Handelsgesetzbuch (Commercial Code of Germany), a legal entity under public law, or a special fund under public law. The same shall apply if the Ordering Party is an entrepreneur pursuant to §§ 14 of the BGB. However, in any case Hofmann & Vratny shall be entitled to sue the Ordering Party at the place of performance of the obligation to deliver under these General Terms of Sale and/or under a prevailing individual agreement or at the Ordering Party's general jurisdiction. Prevailing legal regulations including, but not limited to, regarding exclusive jurisdictions, shall remain unaffected.

Hofmann & Vratny OHG
June 2022

CONTACT HOFMANN & VRATNY

Hofmann & Vratny OHG - Headquarters

Steinkirchen 4½

85617 Aßling

Telephone: +49 80 92 / 85 333-0

E-Mail: info@vhmhv.de

Hofmann & Vratny OHG - Regrinding centre

Poststr. 15a

90471 Nürnberg

Telephone: +49 80 92 / 85 333-152

E-Mail: nbg@vhmhv.de

A RELIABLE PARTNER

DISCOVER OUR H&V PRODUCT RANGE.

Our goal is to provide companies around the world with the best tools.

We are constantly developing our product portfolio. We experiment with new geometries, coatings and materials at our research and development center to make the right tool for every application.

SCAN THE
QR CODE NOW



EXPERT | Non-ferrous materials



EXPERT | Steel & cast iron



EXPERT | Stainless steel



EXPERT | Titanium

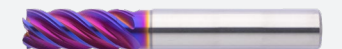

BASIC | Universal





EN

HOFMANN & VRATNY HARDENED STEEL-BROCHURE

Hofmann & Vratny OHG
Steinkirchen 4½
85617 Aßling

Telephone: +49 80 92 / 85 333-0
E-Mail: info@vhmhv.de
Web: www.vhmv.de



OFFICIAL PARTNER OF H&V

