



Expert

2025

HOFMANN & VRATNY — EXM1 SERIES — STAINLESS STEELS EN

EXM1 SERIES



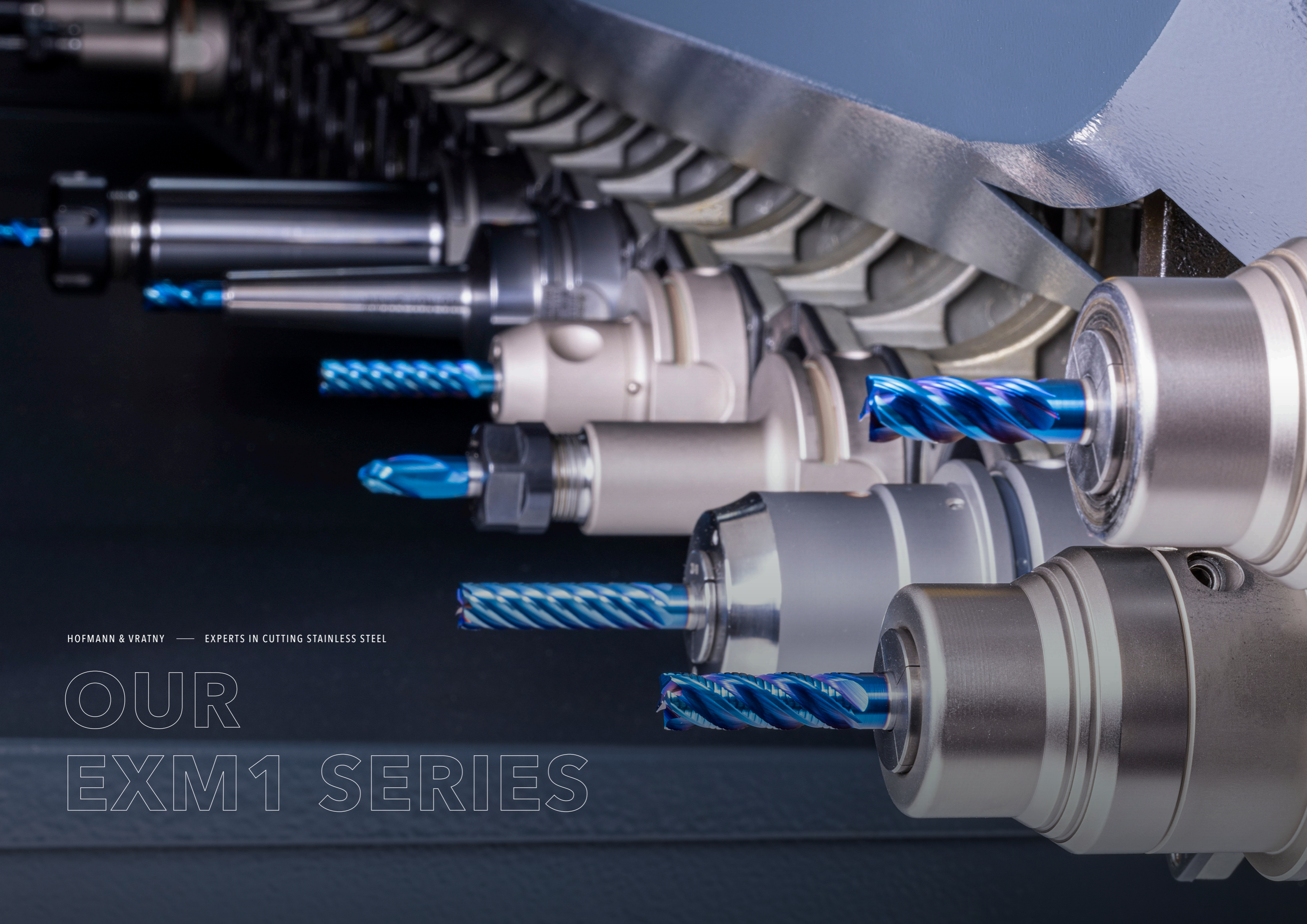

HOFMANN & VRATNY — EXPERTS IN CUTTING STAINLESS STEEL

OUR EXM1 SERIES

THE RIGHT TOOL. AT ALL TIMES.

Welcome to Hofmann & Vratny. As leading manufacturer of solid carbide tools, we enable companies throughout the world to manufacture their products.

Every day, our strong team works on our collective goal of producing the best tools in the world. Companies from the medical industry, semi-conductor industry, machine and plant construction, aviation, aerospace engineering and, not least, the automotive industry have been using our milling cutters for decades now. Quality – Made in Bavaria.

The success of our company is built on innovation, a culture of cooperation, open interaction with high respect and many years of successful and trustful collaboration with our business partners. You can always count on us, our tools and our irreplaceable drive to shape the future of the industry together. To us, that means shaping tomorrow.

Andreas Vratny

Zdenek Vratny

Marius Heinemann-Grüder



OUR
EXM1 SERIES

49
YEARS OF
EXPERIENCE

2 Mio.
TOOLS
PRODUCED
EVERY YEAR

MILLING CUTTERS



**MADE IN
BAVARIA**

PROVEN QUALITY

DRILLS



**MADE IN
CZECHIA**

PROVEN QUALITY

- Manufacturer of solid carbide cutting tools for a wide range of materials
- Founded 1976
- 2 locations in Bavaria and 1 location in Czechia
- Headquarters with milling cutter production in Aßling near Munich
- Regrinding center in Nuremberg
- Location with drill production in Ivančice near Brno



BEHIND THE SCENES

PRODUCTION ENVIRONMENT: ALWAYS UP TO DATE



On a production area of 3,751m², we produce around 2 million tools per year. In order to guarantee the precise manufacture of our tools, our clean production halls are kept at a constant temperature of 24 °C.

PLANT FOR MACRO TOOLS

- Manufacturing of diameter 8 - 32 mm
- Use of 5 & 6-axis CNC grinding machines with 12-position grinding wheel changer enable us to manufacture complex tool geometries
- Radius tolerance of less than 5 µm
- Laser micrometer with measuring ranges up to 50 mm covers a wide product range

PLANT FOR MICRO TOOLS

- Manufacturing from diameter 0.1 - 6 mm
- Use of 5 & 6-axis CNC grinding machines especially with linear and hydrostatic technology
- Tolerances are 3 µm for concentricity and radii and 5 µm for diameter
- CNC measuring machines for recording and measuring the smallest geometries up to 0.1 mm diameter

PLANT FOR SC DRILLS

- Production of standard and special drills
- Use of 5 & 6-axis grinding machines with steady rest
- Measuring technology for particularly long tools

DEPARTMENT FOR SPECIAL TOOLS

- Production of a wide range of semi-standard and special tools
- The delivery times for the special milling cutters are as follows:
 - 3 weeks uncoated
 - 4 weeks coated
 - 6 weeks diamond-coated

REGRINDING CENTRE

- Original reconditioning of Hofmann & Vratny tools
- Regrinding of third-party tools
- The delivery times for reground tools are as follows:
 - without colour coating: 21 calendar days
 - with colour coating: 28 calendar days

RESEARCH & DEVELOPMENT: THE ORIGIN OF OUR INNOVATIONS



In our R&D department, we develop various milling cutter geometries and work together with our partners on innovative coatings and high-performance substrates. Furthermore, on a total of four CNC milling machines, our milling cutters and those of our competitors are tested here every day in order to develop our tools in the best possible way for state-of-the-art production processes.

WAREHOUSE & LOGISTICS: SHIPPING TOGETHER

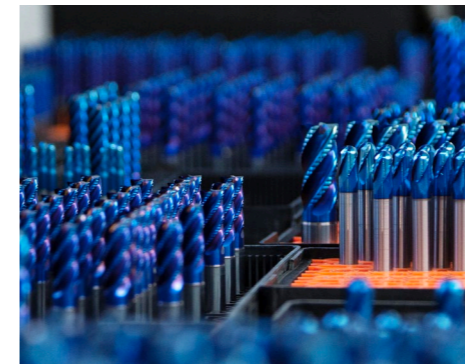

Through our global partner and trading network, we supply the manufacturing industries worldwide and work hand in hand to develop tools that meet customer requirements and market demands. In our warehouse and logistics department, our tools go through a multi-stage process every day to ensure that they reach the customer in perfect condition. With a stock availability of over 98.5 %, we guarantee same-day dispatch for orders received by 3 pm.

PEOPLE ARE THE CENTRE OF ALL OUR ACTIVITIES



Every day, our team makes a significant contribution to the success of our company, which is why it is all the more important to us that our employees feel comfortable and enjoy their work alongside their day-to-day tasks. To contribute to the well-being of our employees, we offer:

- a daily free hot lunch in our canteen
- free hot and cold drinks
- many social benefits

WOULD YOU LIKE TO GET YOUR OWN IMPRESSION OF US?

Then come and visit us with our partner.

GET EVEN MORE INSIGHTS
BEHIND THE SCENES:



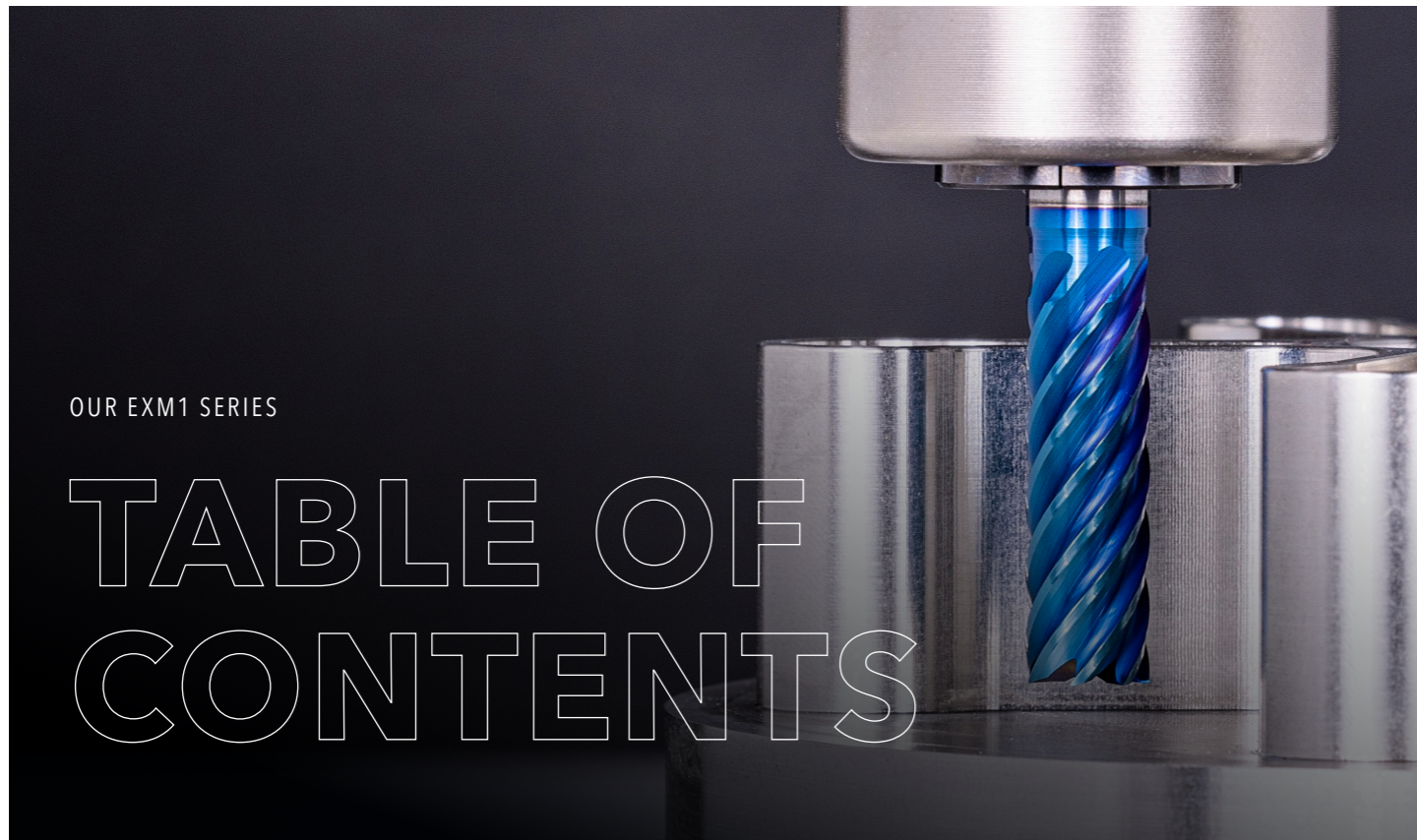

OUR EXM1 SERIES

TABLE OF CONTENTS

THE NEW EXM1-SERIES	12
THE EXM1 SERIES AT A GLANCE	14
COMPARING THE PERFORMANCE WITHIN THE EXM1 SERIES	19
COMPARISON WITH THE PREVIOUS VERSION - PERFORMMAKER Z4 2XD ANNEX (V2A)	20
COMPARISON WITH THE PREVIOUS VERSION - PERFORMMAKER Z4 2XD ANNEX (V4A)	22
COMPARISON WITH THE PREVIOUS VERSION - PERFORMMAKER Z4 2XD ANNEX (FULL SLOT)	24
COMPARISON WITH THE PREVIOUS VERSION - PERFORMMAKER Z4 2XD ANNEX (UNSTABLE CLAMPING)	26
HIGH PERFORMANCE COATING ALPHANOX NAVY X	28
DIGITAL SERVICES	30
NUMBERING SYSTEM	31
EXPLANATION OF CUTTING DATA	32

EXM1-M01 PERFORMMAKER | END MILL CUTTER

EXM1-M01-0213 EXM1 Performmaker Z4 1.5xD ANNEX	34
EXM1-M01-0214 EXM1 Performmaker Z4 1.5xD ANNEX	36
EXM1-M01-0223 EXM1 Performmaker Z4 2xD ANNEX	38
EXM1-M01-0224 EXM1 Performmaker Z4 2xD ANNEX	42
EXM1-M01-0323 EXM1 Performmaker Z4 3xD ANNEX	44
EXM1-M01-0324 EXM1 Performmaker Z4 3xD ANNEX	46
EXM1-M01-0423 EXM1 Performmaker Z4 2xD overlong ANNEX	48
EXM1-M01-0424 EXM1 Performmaker Z4 2xD overlong ANNEX	50
EXM1-M01-0523 EXM1 Performmaker Z4 2xD ANNEX	52
EXM1-M01-0524 EXM1 Performmaker Z4 2xD ANNEX	54



EXM1-M02 SLOTMAKER | ROUGHING CUTTER

EXM1-M02-0123 EXM1 Slotmaker Z4 2xD ANNEX	56
EXM1-M02-0124 EXM1 Slotmaker Z4 2xD ANNEX	58
EXM1-M02-0153 EXM1 Slotmaker Z4 3xD ANNEX	60
EXM1-M02-0154 EXM1 Slotmaker Z4 3xD ANNEX	62
EXM1-M02-0323 EXM1 Slotmaker Z4 4xD ANNEX	64
EXM1-M02-0324 EXM1 Slotmaker Z4 4xD ANNEX	66
EXM1-M02-0623 EXM1 Slotmaker Z4 2xD overlong ANNEX	68
EXM1-M02-0624 EXM1 Slotmaker Z4 2xD overlong ANNEX	70

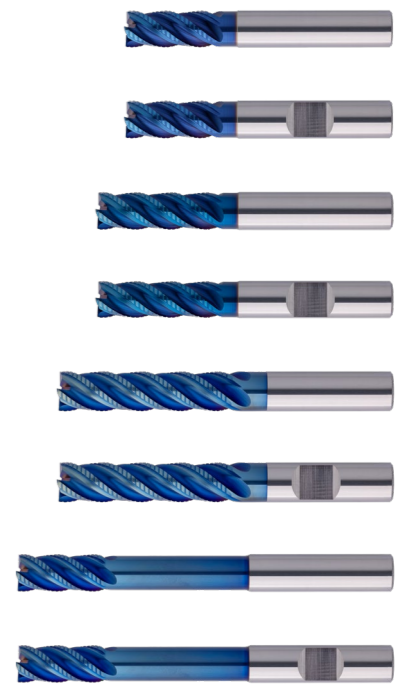

EXM1-M03 CHIPMAKER | TROCHOIDAL CUTTER

EXM1-M03-0103 | EXM1 Chipmaker Z6 2xD ANNX _____ 72

EXM1-M03-0104 | EXM1 Chipmaker Z6 2xD ANNX _____ 76

EXM1-M03-0113 | EXM1 Chipmaker Z6 3xD ANNX _____ 80

EXM1-M03-0114 | EXM1 Chipmaker Z6 3xD ANNX _____ 82

EXM1-M03-0123 | EXM1 Chipmaker Z6 4xD ANNX _____ 84

EXM1-M03-0124 | EXM1 Chipmaker Z6 4xD ANNX _____ 88

EXM1-M03-0133 | EXM1 Chipmaker Z6 5xD ANNX _____ 92

EXM1-M03-0134 | EXM1 Chipmaker Z6 5xD ANNX _____ 94

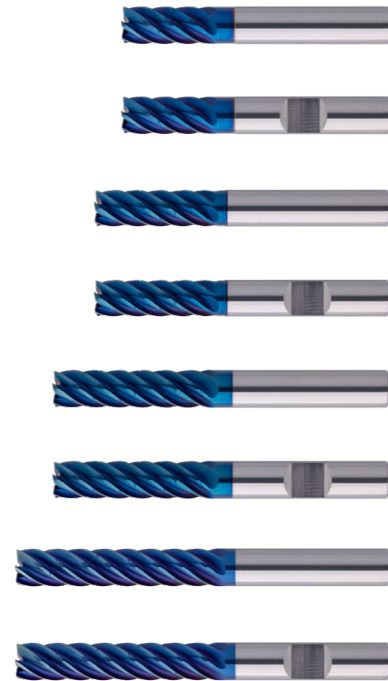

EXM1-M04 MIRRORMAKER | FINISHING CUTTER

EXM1-M04-0033 | EXM1 Mirrormaker Z7 3xD ANNX _____ 96

EXM1-M04-0043 | EXM1 Mirrormaker Z7 4xD ANNX _____ 98

EXM1-M04-0053 | EXM1 Mirrormaker Z7 5xD ANNX _____ 100



EXM1-M06 FORMMAKER | TORUS CUTTER

EXM1-M06-0053 | EXM1 Formmaker Z4 2xD ANNX _____ 102

EXM1-M06-0054 | EXM1 Formmaker Z4 2xD ANNX _____ 106

EXM1-M06-0123 | EXM1 Formmaker Z5 2xD ANNX _____ 110

EXM1-M06-0124 | EXM1 Formmaker Z5 2xD ANNX _____ 114

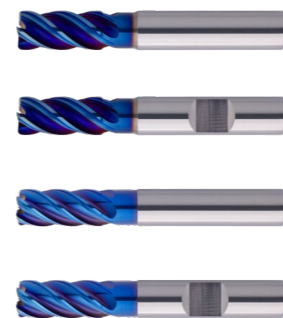

EXM1-M08 ROWMAKER | FULL RADIUS CUTTER

EXM1-M08-0003 | EXM1 Rowmaker Z2 1xD short ANNX _____ 118

EXM1-M08-0013 | EXM1 Rowmaker Z2 1xD long ANNX _____ 120

EXM1-M08-0203 | EXM1 Rowmaker Z4 1xD short ANNX _____ 122

EXM1-M08-0223 | EXM1 Rowmaker Z4 1xD long ANNX _____ 124

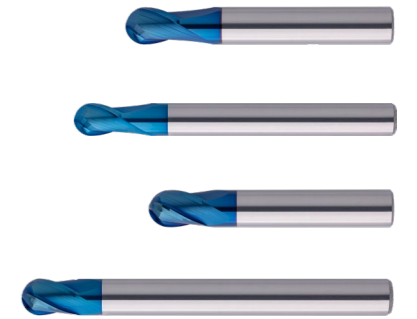

EXM1-M26 SMOOTHMAKER | BALL CUTTER

EXM1-M26-0123 | EXM1 Smoothmaker Z4 280° ANNX _____ 126



EXPLANATION _____ 128

MATERIAL OVERVIEW _____ 130

TECHNICAL FORMULAS _____ 140

GENERAL TERMS OF SALE _____ 142

DISCOVER OUR H&V PRODUCT RANGE _____ 147

OUR EXM1 SERIES

Experts in cutting stainless steel

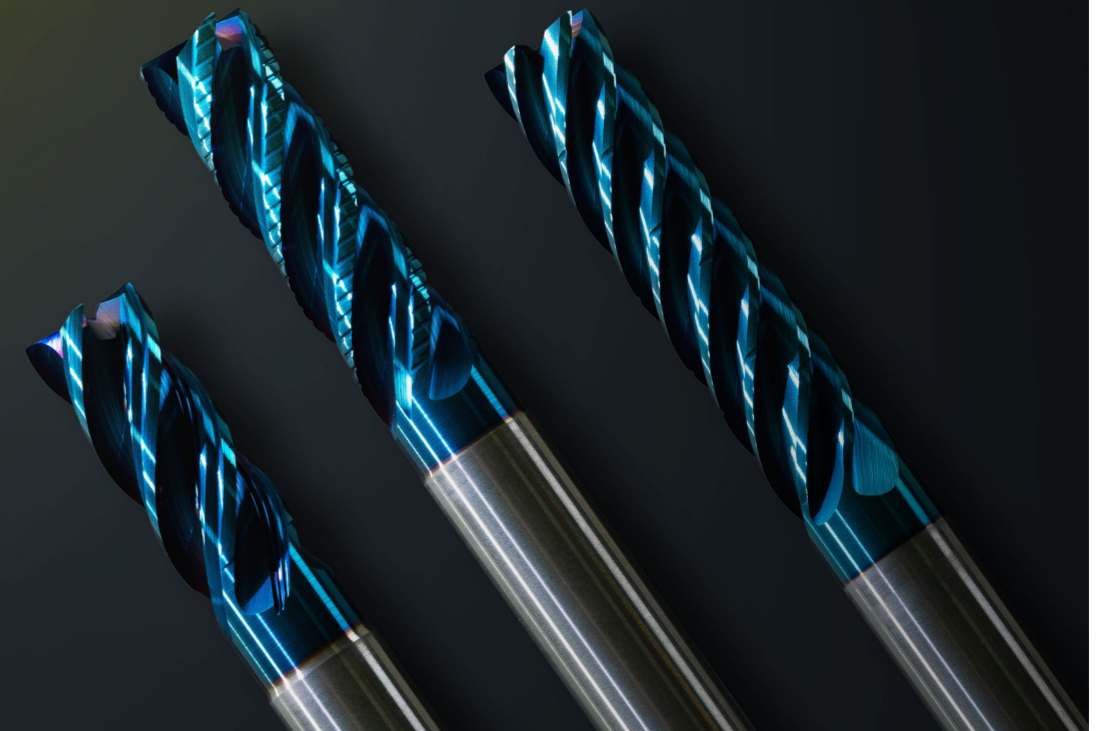

OUR EXM1 SERIES PERFORMS WELL EVEN WITH THE MOST DEMANDING STAINLESS STEELS, OTHERWISE KNOWN AS SUPER DUPLEX STEELS

Stainless steels are very popular in industry not only because of their corrosion resistance, they are also hygienic, temperature-resistant and extremely durable. Stainless steels are mostly used in the food industry, medical technology, the pharmaceutical industry, the chemical industry and in the off-shore sector. Depending on the requirements, different alloys are used, which are classified into the following categories:

- Ferritic
- Martensitic
- Austenitic
- Austenitic-ferritic (duplex)

The H&V EXM1 Series was developed to reliably machine these different structures and also to withstand components such as nickel, manganese, tungsten or titanium.

- Designed for high productivity and lasting durability
- Ultra-fine grain substrate specially developed for demanding material structures. Maximum bending strength and fracture toughness combined with moderate hardness
- Innovative tool geometries ensure a wide range of uses and enable use in a wide variety of milling techniques

A SPECIAL EDGE PREPARATION PROCESS ENSURES:

- Entirely homogeneous cutting edges
- Even distribution of cutting forces
- Improved surface quality of the component
- Controlled and even wear



DISCOVER THE EXM1 SERIES IN ACTION

BEFORE EDGE PREPARATION



AFTER EDGE PREPARATION

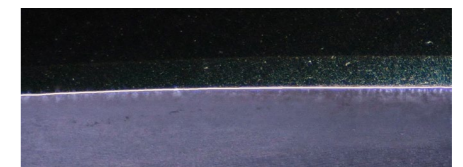



Adapted face with two cutting edges up to the centre, for process-reliable ramping and helical plunging

Reinforced cutting edge with protective radius for maximum stability

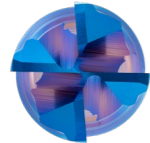

EXPERT M1 PERFORMMAKER (M01) Z4



► IN ACTION

- Updated version and successor product of the previous Performmaker Z4
- Optimised microgeometry with higher vibration resistance and increased cutting edge stability
- Designed for large radial cutting depths, full slot milling up to 1xD and trochoidal cutting
- Special unequal tooth pitch paired with variable helical pitch for perfectly smooth running even at the highest cutting and feed rates
- Particularly stable tool core with slightly conical shape
- Available in 1.5xD, 2xD and 3xD as well as in 2xD as extra-long version
- Available as HA and HB
- With ANNX coating



Adapted face with two cutting edges up to the centre, for process-reliable ramping and helical plunging

Reinforced cutting edge with protective radius for maximum stability

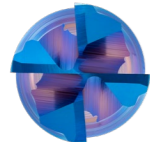

EXPERT M1 PERFORMMAKER (M01) Z4



► IN ACTION

- New version with main focus on all CrNi steels (M1.1, M2.1, V2A)
- Specially designed to withstand the fluctuating additions of CrNi steels
- Optimised for large radial cutting depths and trochoidal cutting
- Special unequal tooth pitch paired with variable helical pitch for perfectly smooth running even at the highest cutting and feed rates
- Particularly stable tool core with slightly conical shape
- Available in 2xD
- Available as HA and HB
- With ANNX coating



Adapted face with two cutting edges cutting to the centre for reliable helical immersion

Reinforced cutting edge with protection radius for maximum stability

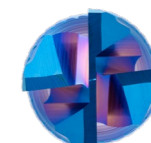

EXPERT M1 SLOTMAKER (M02) Z4



► IN ACTION

- Optimised knurled toothing for the smallest chips in volume machining
- Particularly stable tool core with a slightly conical shape
- Special unequal tooth pitch paired with variable helical pitch for perfectly smooth running even at the highest cutting and feed speeds
- Extra-large chip chambers for safe chip evacuation with high radial depth of cutting
- Available in 2xD, 3xD and 4xD as well as in 2xD as extra-long version
- Available as HA and HB
- With ANNX coating



Adapted face cutting edge for reliable helical immersion

Corner radii up to R = 2.0 mm available

Radius tolerance determined by radius
≤ 1.5 mm: ± 0.003 mm
> 1.5 mm: ± 0.005 mm

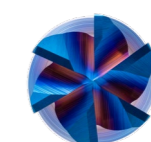

EXPERT M1 CHIPMAKER (M03) Z6



► IN ACTION

- Six cutting edges for an optimised performance and an excellent chip removal rate
- Reinforced chip cups for high radial cutting depths
- Optimised chip spaces for perfect removal of chips that tend to stick
- Special unequal tooth pitch coupled with variable helical pitch for perfectly smooth running
- Available in 2xD, 3xD and 4xD
- Available as HA and HB
- With ANNX coating



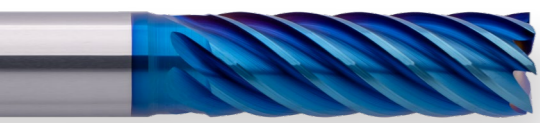

Face-finish bevel for smooth workpiece surfaces

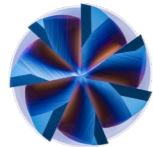

EXPERT M1 MIRRORMAKER (M04) Z7



► IN ACTION

- Seven cutting edges with a special finish and optimised geometry for the highest surface quality
- Adapted chip spaces for the safe removal of particularly fine and long chips when finishing
- Slightly conical tool core and special helical pitch for the smoothest running possible and dimensional accuracy
- Available in 3xD, 4xD and 5xD
- Available as HA
- With ANNX coating

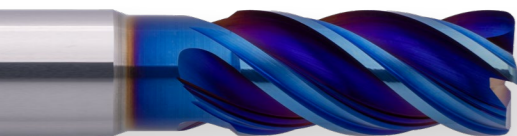

Adapted face with two cutting edges up to the centre, for process-reliable helical plunging

Corner radii up to R = 4.0 mm available for contour milling

Radius tolerance depending on corner radius
 $\leq 1.5 \text{ mm} : \pm 0.003 \text{ mm}$
 $> 1.5 \text{ mm} : \pm 0.005 \text{ mm}$

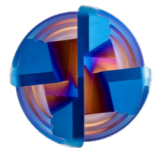

EXPERT M1 FORMMAKER (M06) Z4

- Optimised geometry for contour milling, high radial cutting depths and full slot milling up to 1xD
- Special unequal tooth pitch paired with variable helical pitch for perfectly smooth running even at the highest cutting and feed rates
- Particularly stable tool core with slightly conical shape
- Available in 2xD
- Available as HA and HB
- With ANNX coating

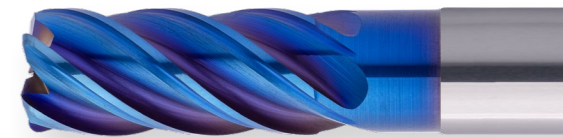

One cutting edge cutting to the center for finishing and reliable helical immersion

Corner radii up to R = 4.0 mm available for contour milling

Radius tolerance determined by radius
 $\leq 1.5 \text{ mm} : \pm 0.003 \text{ mm}$
 $> 1.5 \text{ mm} : \pm 0.005 \text{ mm}$

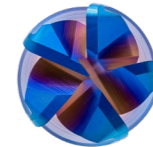

EXPERT M1 FORMMAKER (M06) Z5

- Five cutting edges for high productivity with flexible application
- Adapted geometry for the special challenges of contour milling various stainless steels
- Unequal tooth pitch coupled with variable helical pitch for perfectly smooth running and cutting
- Available in 2xD
- Available as HA and HB
- With ANNX coating

EXPERT M1 ROWMAKER (M08) Z2

- Adapted core for smooth running
- Special chip spaces designed for optimal chip disposal when roughing and finishing
- Defined microbevel for support enables use in the high-speed range
- Optimised cross-cutting edge for maximum stability in the tool centre
- Available in 1.5xD in short and long versions
- Available as HA
- With ANNX coating

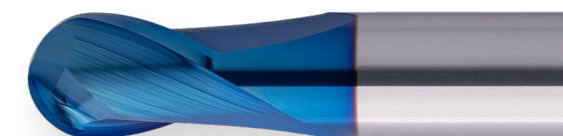

Adapted face geometry for optimum performance and perfect dimensional accuracy

Radius tolerance determined by radius
 $\leq 2 \text{ mm} : \pm 0.003 \text{ mm}$
 $> 2 \text{ mm} : \pm 0.005 \text{ mm}$

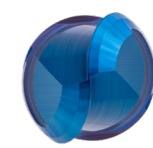



EXPERT M1 ROWMAKER (M08) Z4



▶ IN ACTION

Four cutting edges, right up to the centre

Reinforced face geometry combined with a special finishing bevel for maximum performance and optimum surface quality

Radius tolerance determined by radius
 $\leq 2 \text{ mm} = \pm 0.003 \text{ mm}$
 $> 2 \text{ mm} = \pm 0.005 \text{ mm}$

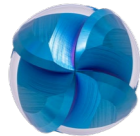

- Adapted wedge angle and helical pitch for smooth running and cutting
- Optimised chip spaces designed for maximum chip disposal, even in the high-speed range
- Maximum cutting performance with four cutting edges
- Available in 1xD in short and long versions
- Available as HA
- With ANNX coating



EXPERT M1 SMOOTHMAKER (M26) Z4

Tolerance of the radius contour = $\pm 0,01 \text{ mm}$

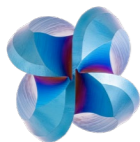

- 4 specially relief-ground cutting edges for efficient 5-axis machining of demanding components
- Thanks to the 280° cutting edge, the entire ball can be utilised and the tool is designed for undercut machining
- Perfectly suited for forward and backward deburring with high surface quality requirements
- Available as HA
- With ANNX coating

PERFORMANCE COMPARISON

COMPARING THE PERFORMANCE WITHIN THE EXM1 SERIES

The tool matrix for our EXM1 Series compares the performance of individual milling cutters within the series. The values clearly show the performance in relation to the respective property in order to help you choose the right tool for every requirement.



Tool matrix

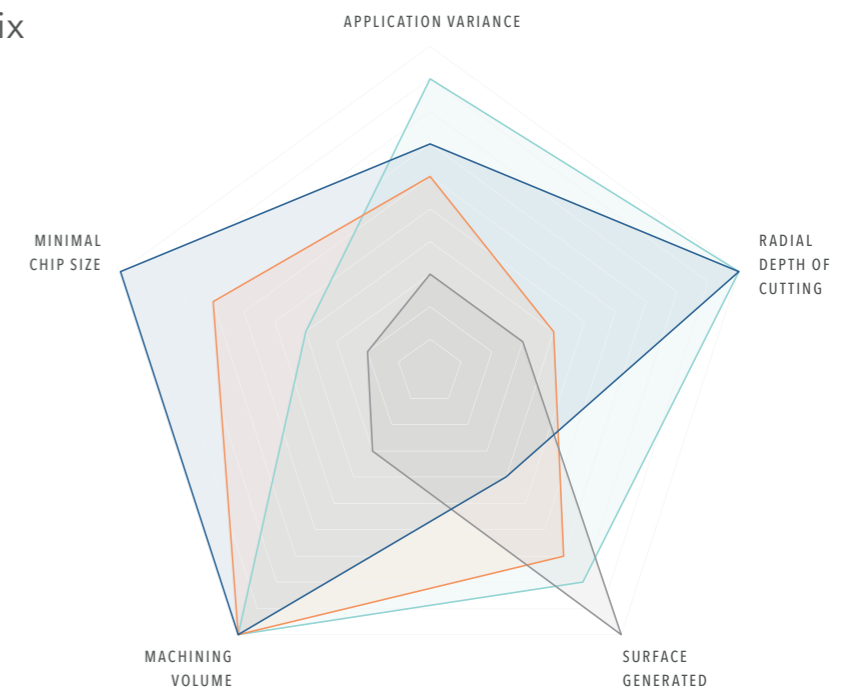

OUR NEW PERFORMMAKERS Z4 2XD ANN (EXM1-M01-0223 / EXM1-M01-0523)

COMPARISON WITH THE PREVIOUS VERSION

Comparison of tool life when multipass milling in V2A - 1.4301 (X5CrNi18-10)

Based on carbide layer tests carried out in our research centre, our new Performmaker has successfully come out on top compared to the previous version.

Technical parameters for multipass milling

Vc	100 m/min
fz	0.062 mm/Z
ap	12 mm
ae	3.6 mm
Cooling	Cooling lubricant

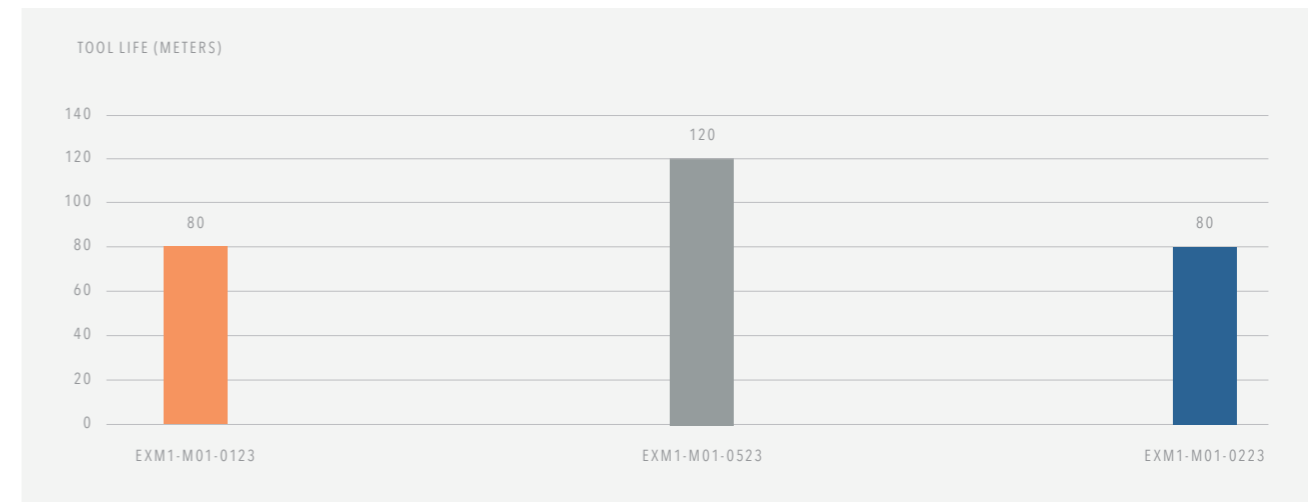
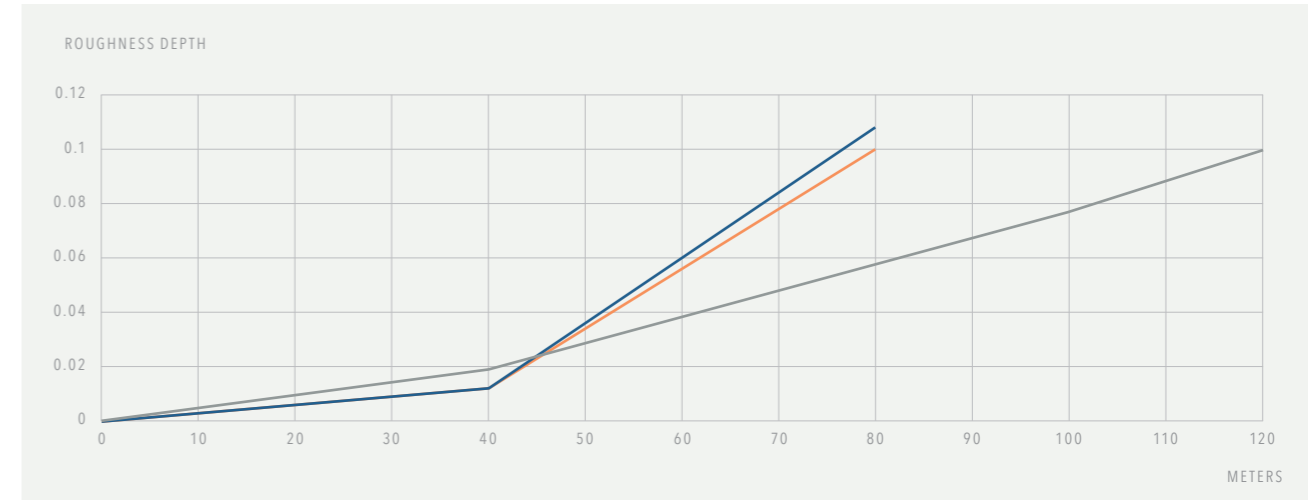

TOOL LIFE CRITERION = WEAR OF CUTTING EDGE AND BREAKOUTS

End mill Z4 Ø10 2xD	Roughness depth after 40 m	Roughness depth after 80 m	Roughness depth after 100 m	Roughness depth after 120 m
EXM1-M01-0123	0,012	0,1		
EXM1-M01-0523	0,019	0,058	0,077	0,1
EXM1-M01-0223	0,012	0,108		

The high-resolution images show our EXM1 Performmakers Z4 at the end of their tool life. Here, our updated version clearly stands out in terms of tool life and cutting edge wear compared to the previous version.

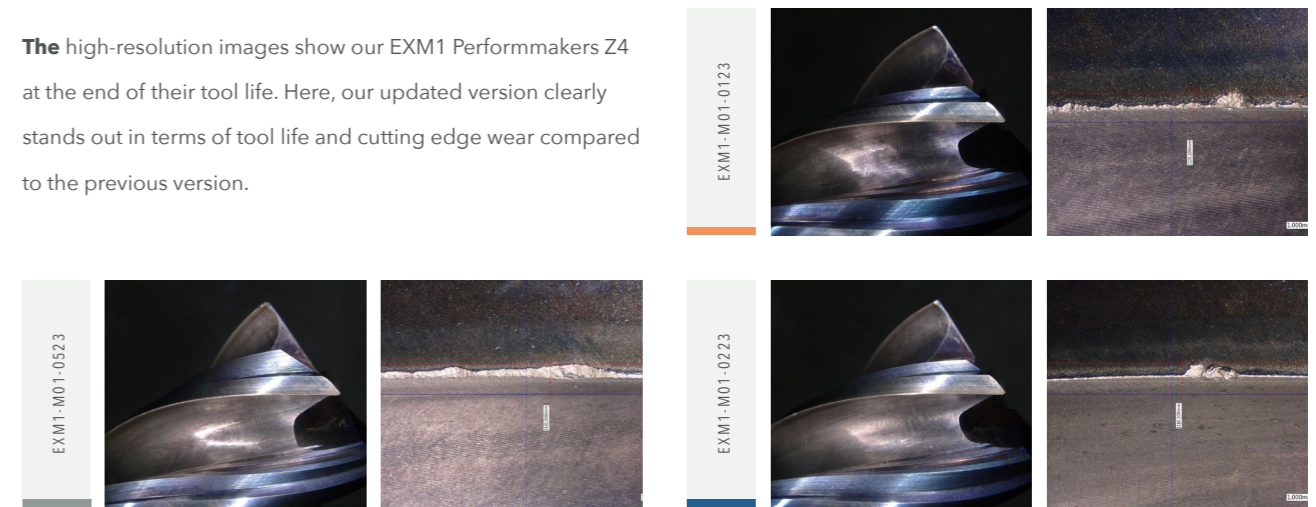

OUR NEW PERFORMMAKERS Z4 2XD ANNEX (EXM1-M01-0223 / EXM1-M01-0523)

COMPARISON WITH THE PREVIOUS VERSION

Comparison of tool life when multipass milling in V4A - 1.4571 (X6CrNiMoTi17-12-2)

Based on carbide layer tests carried out in our research centre, our new Performmaker has successfully come out on top compared to the previous version.

Technical parameters for multipass milling

Vc	85 m/min
fz	0.062 mm/Z
ap	10 mm
ae	3.6 mm
Cooling	Cooling lubricant

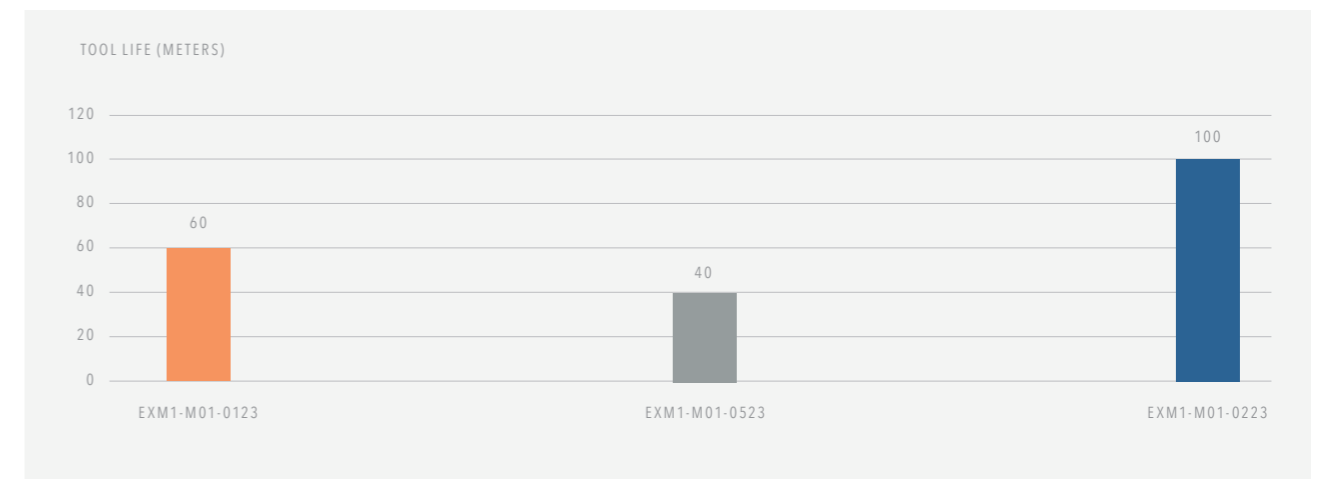
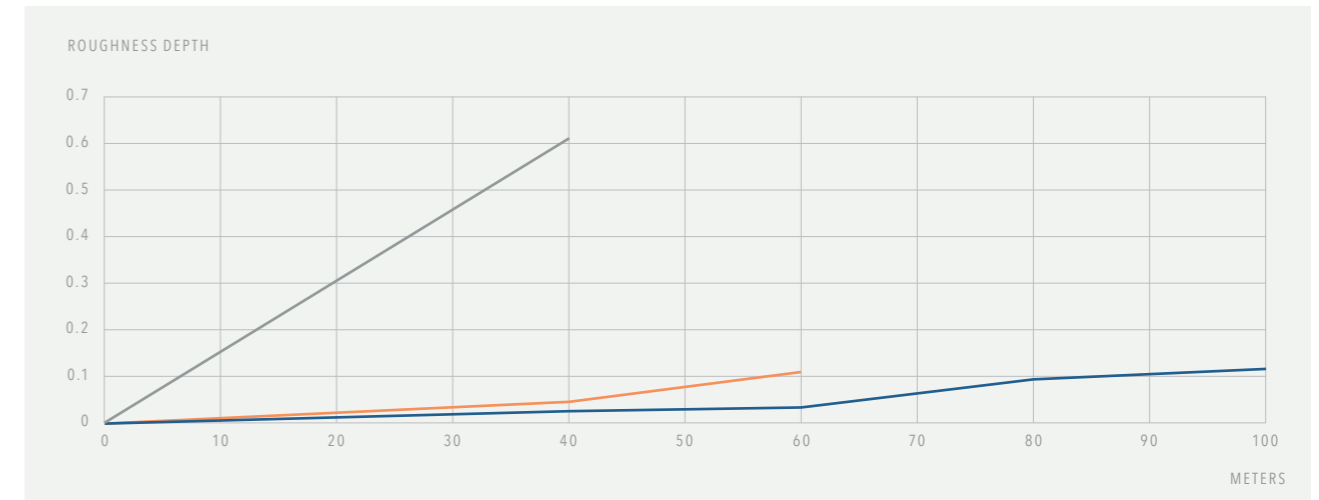

TOOL LIFE CRITERION = WEAR OF CUTTING EDGE AND BREAKOUTS

End mill Z4 Ø10 2xD	Roughness depth after 40 m	Roughness depth after 60 m	Roughness depth after 80 m	Roughness depth after 100 m
EXM1-M01-0123	0.045	0.109		
EXM1-M01-0523	0.611			
EXM1-M01-0223	0.025	0.033	0.094	0.118

The high-resolution images show our EXM1 Performmakers Z4 at the end of their tool life. Here, our updated version clearly stands out in terms of tool life and cutting edge wear compared to the previous version.

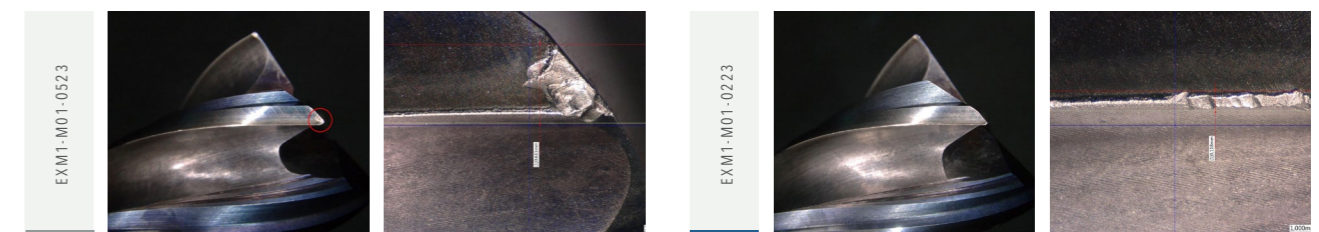

OUR NEW PERFORMMAKER Z4 2XD ANNEX (EXM1-M01-0523)

COMPARISON WITH THE PREVIOUS VERSION

Comparison of tool life when full slot in V2A - 1.4301 (X5CrNi18-10)

Based on carbide layer tests carried out in our research centre, our new Performmaker has successfully come out on top compared to the previous version.

Technical parameters for full slot

Vc	100 m/min
fz	0.052 mm/Z
ap	10 mm
ae	10 mm
Cooling	Cooling lubricant

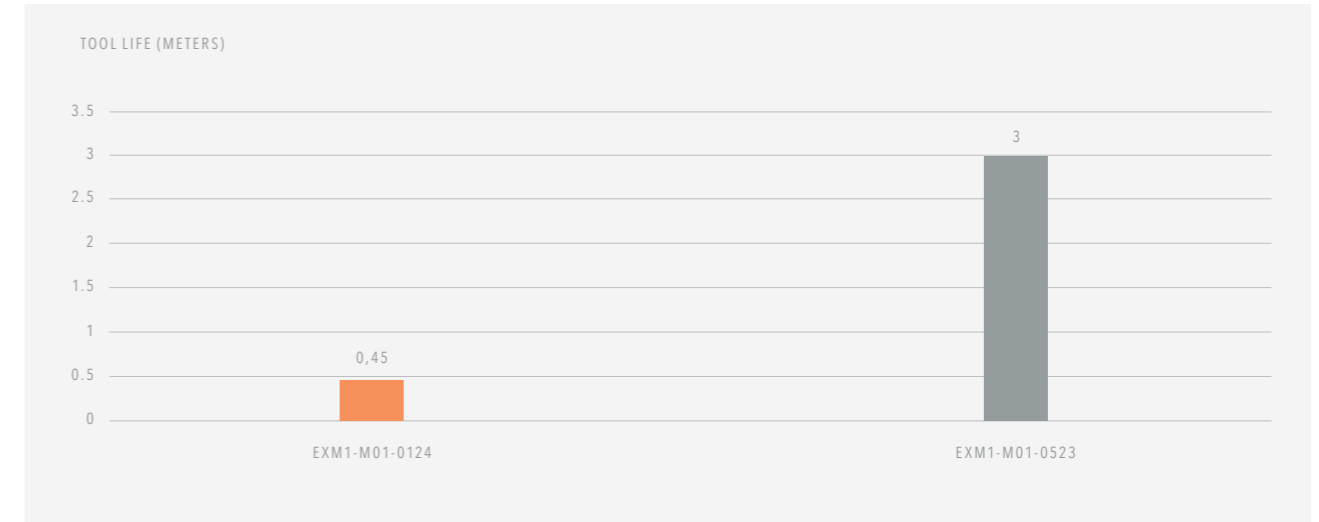

The high-resolution images show our EXM1 Performmakers Z4 at the end of their tool life. Here, our updated version clearly stands out in terms of tool life and cutting edge wear compared to the previous version.

TOOL LIFE CRITERION = WEAR OF CUTTING EDGE AND BREAKOUTS

End mill Z4 Ø10 2xD	Tool life in meters	Wear on cutting edge in mm (average)	Tool life in minutes
EXM1-M01-0124	0.45	broken	0.32
EXM1-M01-0523	3	0.078	6.4

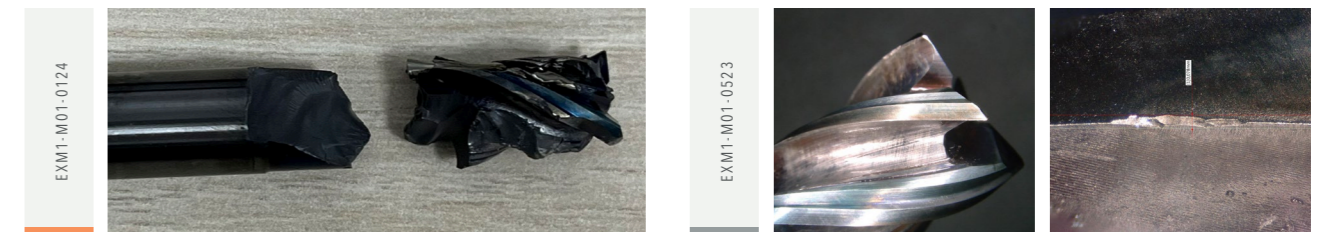

OUR NEW PERFORMMAKER Z4 2XD ANNEX (EXM1-M01-0224)

COMPARISON WITH THE PREVIOUS VERSION

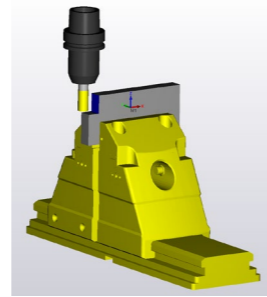

Technical parameters
unstable clamping

Vc	100 m/min
fz	0.085 mm/Z
ap	28 mm
ae	4 mm
Cooling	Cooling lubricant

Comparison of tool life with unstable clamping in V2A - 1.4301 (X5CrNi18-10)

Based on carbide layer tests carried out in our research centre, our new Performmaker has successfully come out on top compared to the previous version.

TOOL LIFE CRITERION = WEAR OF CUTTING EDGE AND BREAKOUTS

End mill Z4 Ø16 2xD	Roughness depth after 0.82 m	Roughness depth after 1.64 m
EXM1-M01-0124	0.25	0.504
EXM1-M01-0523	0.027	0.053

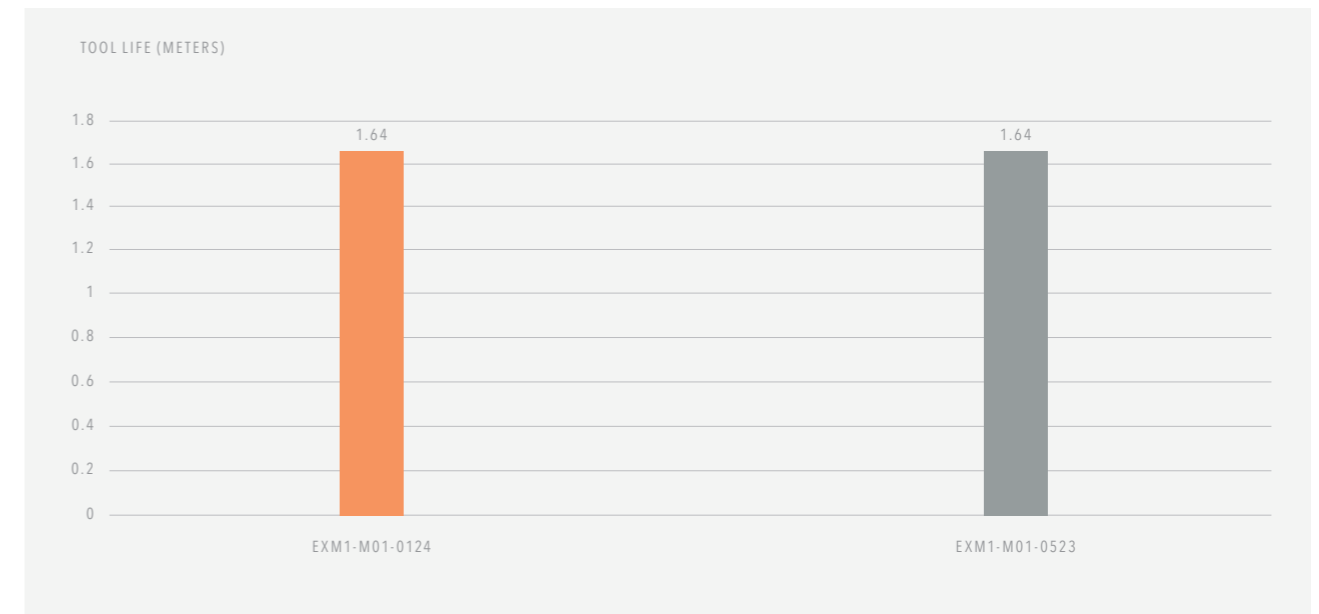
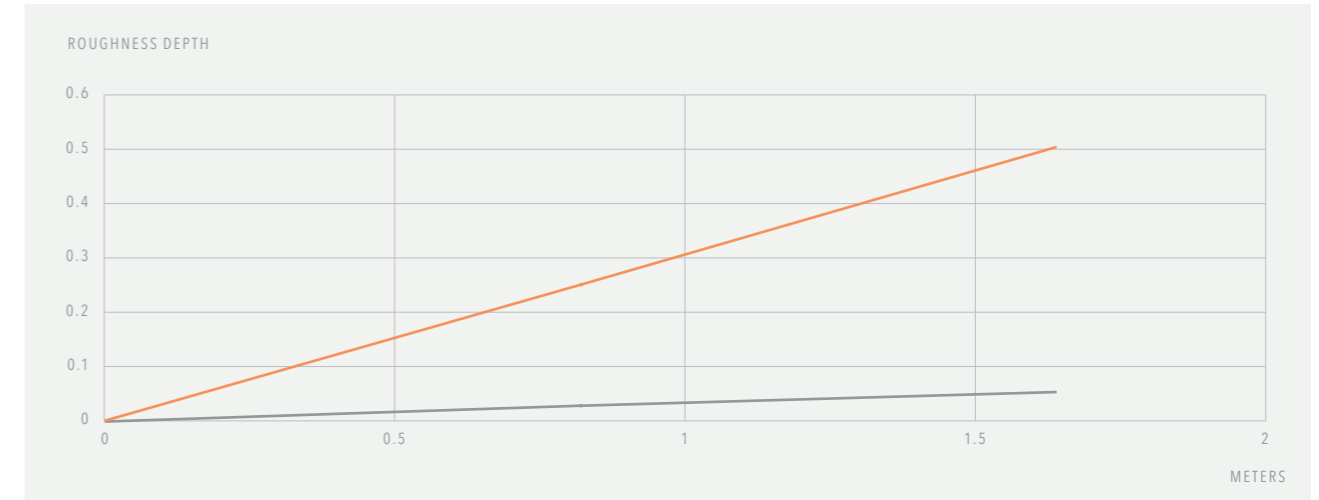

The high-resolution images show our EXM1 Performmakers Z4 at the end of their tool life. Our updated version shows less cutting edge wear than the previous version.



ALPHA NOX NAVY X

ANNX | state-of-the-art, nano-structured multi-layer coating specially designed for machining stainless steel

We have created a new nano-structured multi-layer coating based on AlTiSiCrN in order to process different types of structure and material additives in stainless steel that can be difficult to machine.

Particularly when using super duplex steels, there is immense pressure on the cutting edges. Thanks to the multi-layer, nano-structuring of our new AlphaNox Navy X coating, a high level of elasticity is achieved and the internal stress of the coating is reduced. There is very controlled wear and the coating wears off very evenly. Layer spalling and premature breakouts are effectively prevented.

The key properties of our ANNX coating at a glance:

- Can be widely used with all stainless steels and types of structure
- Breakout prevention through low internal stress and high elasticity of the coating
- Long-lasting protection of the hard metal against material fatigue thanks to special components and structure of the coating

ANNX Outstanding layer smoothing – our new Finishing X technique

Finishing X is the name we have given to a special type of layer smoothing used in combination with AlphaNox Navy that is characterised by unparalleled evenness, more homogeneous wear, and improved wear resistance. It has been developed specially to prevent micro-breakouts caused by droplets coming loose and guarantee a chip disposal process that will remain at its optimum level for a long time. The effects of the symbiosis between our AlphaNox Navy and the Finishing X technique at a glance:

- Improved surface quality during finishing
- Optimised chip disposal due to smooth chip spaces
- Maximum stability for coating and cutting edges
- Reduction of built-up edges and chips sticking on the tool
- Absolute smoothness for a reduced friction coefficient (0.4)

ALPHANOX NAVY X ANN X - AT A GLANCE

Structure	Nanostructured multilayer
Components	Aluminium titanium silicium chromium nitride
Layer thickness	3-4 µm
Layer hardness	approx. 3000 - 3200 HV
Adhesion factor	Friction coefficient: approx. 0.4 (dry on steel)
Max. operating temperature	approx. 1100°C
Cooling	Wet machining (limited suitability for dry machining)
Main application	Stainless Steel
Secondary application (limited suitability)	Titanium, steel and cast iron

Finishing X as viewed through a scanning electron microscope

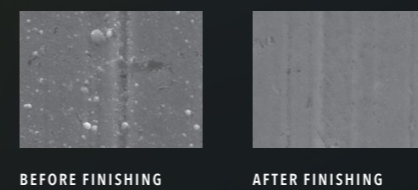

DIGITAL SERVICES



DISTRIBUTION PARTNERS

We enable companies around the world to manufacture their products. Therefore we work with reliable partners all over the world to ensure that our milling cutters are always available exactly where they are needed and can be delivered straight into your hands.

FIND OUT MORE ABOUT OUR GLOBAL SALES PARTNERS



Browse all EXM1 Series products in our shop

Discover the products in the EXM1 Series online or search for the ideal tool for your application based on various product features. We guarantee that you will find the perfect milling cutter for your machining needs using our online platform.



WHAT ARE YOU WAITING FOR?

NUMBERING SYSTEM

DISTINGUISHING FEATURES

PRODUCT LINE

- BC Basic
- EX Expert

TOOL TYPE

- D Drilling
- M Milling
- T Threading
- R Reaming

TOOL VERSION

- M01 End mill cutter | PERFORMMAKER
- M02 Roughing cutter | SLOTMAKER
- M03 Trochoidal cutter | CHIPMAKER
- M04 Finishing cutter | MIRRORMAKER
- M05 Single flute cutter | BALANCEMAKER
- M06 Torus cutter | FORMMAKER
- M07 Face torus cutter | BLADEMAKER
- M08 Full radius cutter | ROWMAKER
- M09 Deburring cutter | CHAMFMAKER
- M10 Forward and backward deburring cutter | FB CHAMFMAKER
- M11 Corner rounding cutter | ROUNDMAKER
- M12 Forward and backward corner rounding cutter | FB ROUNDMAKER
- M13 Engraving cutter | TEXTMAKER
- M14 Conical cutter | SLOPEMAKER
- M15 Micro end mill cutter | PERFORMMAKER MICRO
- M16 Micro torus cutter | FORMMAKER MICRO
- M17 Micro full radius cutter | ROWMAKER MICRO
- M26 Ball cutter | SMOOTHMAKER
- M27 Chamfer cutter | BEVELMAKER
- D01 Spiral drill | COREMAKER

EX M 1 - M 01 - 0293

MAIN APPLICATION

- PK Steel & Cast Iron
- H Hardened Steel
- M Stainless Steel
- O Graphite, CRP/GRP
- T Titanium
- S Superalloy
- N NF Material
- U Universal

VERSION

- 1 Version 1.0
- 2 Version 2.0
- 3 Version 3.0

STILL CAN'T FIND A SUITABLE MILLING CUTTER?

No problem - simply customize an existing tool. Using our configurator for special milling cutters, you can customize existing tools to your needs in an instant or create your own tools based on predefined types.

WE WILL RESPOND TO ALL REQUESTS SUBMITTED VIA THE CONFIGURATOR WITHIN ONE WORKING DAY AT THE LATEST



OTHER DISTINGUISHING FEATURES

EX M 1 - M 01 - 0293 - 12/0,5

PRODUCT IDENT

e.g. 0023

DIMENSION

- 3x10 Cutting diameter x length of undercut
- 12/0,5 Cutting diameter / corner radius
- 10 Diameter

EXPLANATION OF CUTTING DATA

EXAMPLE FOR SIDE MILLING OF 1.4432 WITH Ø10:

M 2.2 STAINLESS STEEL | austenitic <750 N/mm²

Materialnumber	Germany DIN	Europe EN	France AFNOR	Great Britain BS	Italy UNI	Sweden SIS	Spain UNE	Japan JIS	USA AISI
1.4429	X2CrNiMoN17133	X 3 CrNiMoN 17 12 2	Z 2 CND 17.13 Az	316 S 62	X 2 CrNiMoN 17 13	2375		SUS 316 LN	316 LN
1.4432	X2CrNiMo17123	X 2 CrNiMo 17 12 2	Z 3 CND 17 13 30	316 S 13	X 2 CrNiMo 17 12 3			SUS 316L	316 L
1.4434	X2CrNiMoN18124		CLC 18.12.4 LN		X 2 CrNiMoN 18 12 4				317 LN
1.4439	X2CrNiMoN17135	X 3 CrNiMo 17 13 5	Z 3 Cnd 18.14.05 Az						
1.4465	X1CrNiMoN25252								

THE MATERIAL KEY WITH DETAILED BREAKDOWN OF MATERIALS BY MATERIAL GROUP CAN BE FOUND ON PAGE 130 - 140.

Material	Strength (N/mm²)	Full Slot	Side Milling	Finishing	ETC	Materialgroup Factor fz / α	Materialgroup Factor ae ETC
		Vc = m/min	Vc = m/min	Vc = m/min	Vc = m/min		
M STAINLESS STEEL							
1.1 ferritic/martensitic	<850	110	110	120	176	1	1
2.1 austenitic	<650	100	100	110	161	0.95	0.9
2.2 austenitic	<750	90	90	100	142	0.9	0.8
3.1 DUPLEX STEEL super austenitic	<1100	75	75	85	124	0.85	0.7
P STEEL							
1.1-1.5 unalloyed	<1100	180	180	190	240	1	1
2.1-2.4 low alloyed	<1300	145	145	155	180	0.9	0.75
3.1-3.3 high alloyed	<1400	135	135	145	165	0.8	0.7
K CASTINGS							
1.1 grey cast iron	<1000	200	200	210	240	0.9	0.8
T TITANIUM							
2.1-2.3 pure/alloyed	<1000	50	50	55	100	0.7	0.5

OVERVIEW OF THE DIFFERENT MATERIAL GROUPS FOR THIS TOOL INCLUDING FACTORS

Material M 1.1

D1	L2	Immersion Angle	Full Slot			Side Milling			Finishing			ETC				
			fz	ae = 1xD	ap = 1xD	fz	ae = 0.3xD	ap	fz	ae	ap	fz	ae	ap	hmax	
Ø	mm	α°	(mm/Z)	(mm)	(mm)	(mm/Z)	(mm)	(mm)	(mm/Z)	(mm)	(mm)	(mm/Z)	(mm)	(mm)	(mm)	(mm)
3	6	4°	0.02	3	3	0.03	0.9	L2max	0.018	0.2	L2max	0.05	0.4	L2max	0.034	
4	8	6°	0.025	4	4	0.035	1.2	L2max	0.021	0.2	L2max	0.06	0.6	L2max	0.0428	
5	9	8°	0.03	5	5	0.04	1.5	L2max	0.02	0.2	L2max	0.07	0.7	L2max	0.0486	
6	10	10°	0.035	6	6	0.045	1.8	L2max	0.025	0.2	L2max	0.08	0.9	L2max	0.0571	
8	12	15°	0.05	8	8	0.06	2.4	L2max	0.03	0.2	L2max	0.1	1.1	L2max	0.0689	
10	14	25°	0.055	10	10	0.07	3	L2max	0.035	0.2	L2max	0.12	1.3	L2max	0.0807	
12	16	45°	0.06	12	12	0.08	3.6	L2max	0.04	0.2	L2max	0.14	1.5	L2max	0.0926	
16	22	45°	0.07	16	16	0.09	4.8	L2max	0.045	0.2	L2max	0.17	1.9	L2max	0.11	
20	26	45°	0.09	20	20	0.11	6	L2max	0.05	0.2	L2max	0.21	2.1	L2max	0.1288	

ALL DATA GIVEN HERE IS FOR THE FIRST GROUP N1.1 IN THE MATERIAL GROUP OVERVIEW

DETERMINATION OF CUTTING DATA:

From the material key (page 130 - 140) results: material group M2.2
 Vc= 90 m/min (as indicated in the table)
 fz= 0.07 mm/Z (as indicated in the table) x Factor fz 0.9 = fz 0.063 mm/Z

EXAMPLE FOR ETC OF 1.4460 WITH Ø10:

M 3.1 DUPLEX STEEL | super austenitic <1100 N/mm²

Materialnumber	Germany DIN	Europe EN	France AFNOR	Great Britain BS	Italy UNI	Sweden SIS	Spain UNE	Japan JIS	USA AISI
1.4162	X2CrMnNiN2252	X 2 CrMnNiN 22 5 2			X 2 CrMnNiN 21 5 1		S32101	LDX 2101	S321 01
1.4362	X2CrNiN234	X 2 CrNiN 23 4	Z 3 CN 23 04 AZ			2327			S323 04
1.4410	X2CrNiMoN2574	X 2 CrNiMoN 25 7 4	Z 5 CND 20.10 M		X 2 CrNiMoN 25 7 4			SCS 14 A	S327 50
1.4460	X4CrNiMo2752	X 3 CrNiMo 27 5 2	X 2 CrNiMo 25 7 3		X 3 CrNiMo 27 5 2	2324	X 8 CrNiMo 27 05	SUS 329 J1	S325 50
1.4462	X2CrNiMoN2253	X 2 CrNiMoN 22 5 3	Z 3 CND 22.05 AZ	318 S 13	X 2 CrNiMoN 22 5 3	2377		SUS 329 J3L	S318 03



VIDEO EXPLANATION

THE MATERIAL KEY WITH DETAILED BREAKDOWN OF MATERIALS BY MATERIAL GROUP CAN BE FOUND ON PAGE 130 - 140.

Material	Strength (N/mm²)	Full Slot	Side Milling	Finishing	ETC	Materialgroup Factor fz / α	Materialgroup Factor ae ETC
		Vc = m/min	Vc = m/min	Vc = m/min	Vc = m/min		
M STAINLESS STEEL							
1.1 ferritic/martensitic	<850	110	110	120	176	1	1
2.1 austenitic	<650	100	100	110	161	0.95	0.9
2.2 austenitic	<750	90	90	100	142	0.9	0.8
3.1 DUPLEX STEEL super austenitic	<1100	75	75	85	124	0.85	0.7
P STEEL							
1.1-1.5 unalloyed	<1100	180	180	190	240	1	1
2.1-2.4 low alloyed	<1300	145	145	155	180	0.9	0.75
3.1-3.3 high alloyed	<1400	135	135	145	165	0.8	0.7
K CASTINGS							
1.1 grey cast iron	<1000	200	200	210	240	0.9	0.8
T TITANIUM							
2.1-2.3 pure/alloyed	<1000	50	50	55	100	0.7	0.5

OVERVIEW OF THE DIFFERENT MATERIAL GROUPS FOR THIS TOOL INCLUDING FACTORS

Material M 1.1

D1	L2	Immersion Angle	Full Slot			Side Milling			Finishing			ETC			
			fz	ae = 1xD	ap = 1xD	fz	ae = 0.3xD	ap	fz	ae	ap	fz	ae	ap	hmax
Ø	mm	α°	(mm/Z)	(mm)	(mm)	(mm/Z)	(mm)	(mm)	(mm/Z)	(mm)	(mm)	(mm/Z)	(mm)	(mm)	(mm)
3	6	4°	0.02	3	3	0.03	0.9	L2max	0.018	0.2	L2max	0.05	0.4	L2max	0.034
4	8	6°	0.025	4	4	0.035	1.2	L2max	0.021	0.2	L2max	0.06	0.6	L2max	0.0428
5	9	8°	0.03	5	5	0.04	1.5	L2max	0.02	0.2	L2max	0.07	0.7	L2max	0.0486
6	10	10°	0.035	6	6	0.045	1.8	L2max	0.025	0.2	L2max	0.08	0.9	L2max	0.0571
8	12	15°	0.05	8	8	0.06	2.4	L2max	0.03	0.2	L2max	0.1	1.1	L2max	0.0689
10	14	25°	0.055	10	10	0.07	3	L2max	0.035	0.2	L2max	0.12	1.3	L2max	0.0807
12	16	45°	0.06	12	12	0.08	3.6	L2max	0.04	0.2	L2max	0.14	1.5	L2max	0.0926
16	22	45°	0.07	16	16	0.09	4.8	L2max	0.045	0.2	L2max	0.17	1.9	L2max	0.11
20	26	45°	0.09	20	20	0.11	6	L2max	0.05	0.2	L2max	0.21	2.1	L2max	0.1288

ALL DATA GIVEN HERE IS FOR THE FIRST GROUP N1.1 IN THE MATERIAL GROUP OVERVIEW

DETERMINATION OF CUTTING DATA:

From the material key (page 130 - 140) results: material group M3.1
 Vc= 124 m/min (as indicated in the table)
 fz= 0.12 mm/Z (as indicated in the table) x Factor fz 0.85 = fz 0.102 mm/Z
 ae= 1.3 mm (as indicated in the table) x Factor ae 0.7 = 0.91 mm ae

Cooling	
Tolerance	e8
Coating	AlphaNox Navy X

Strategy	ETC	HPC				
Application						
Features	HA	≠		1,5xD	R	



Download Catalog Pages (PDF)

Material	Strength (N/mm ²)	Full Slot	Side Milling	Finishing	ETC	Materialgroup Factor fz / α	Materialgroup Factor ae ETC
----------	-------------------------------	-----------	--------------	-----------	-----	-----------------------------	-----------------------------

- Optimized microgeometry with higher vibration resistance and increased cutting edge stability
- Special unequal tooth pitch combined with variable helical pitch for smooth running

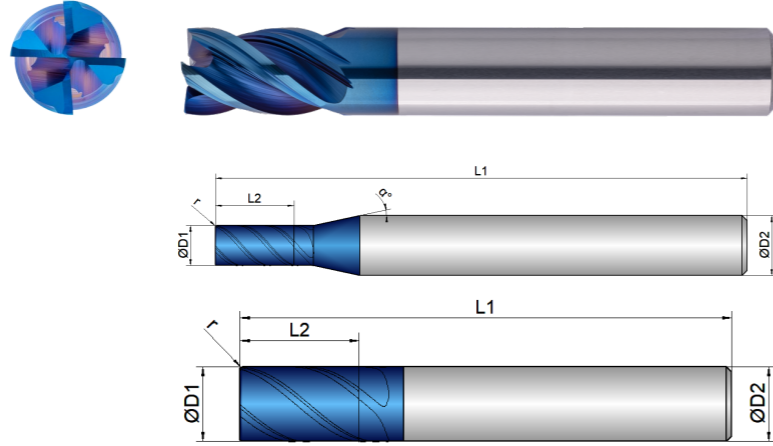

- Designed for maximum removal rate when milling with high radial depth of cut and in the full slot up to 1xD
- For process reliable ramping, helical immersion and diving (drilling) up to 1xD

- Update version and successor product for EXM1-M01-0113
- Universally applicable in all stainless steels

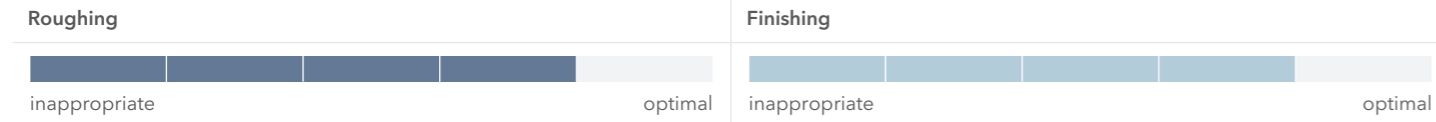

EXM1-M01-0213	D1 mm Ø	L2 mm	L1 mm	D2 mm Ø	z #	r mm	α °
0,5	0.5	0.9	50.0	4.0	4	0.02	12
0,8	0.8	1.4	50.0	4.0	4	0.03	12
1	1.0	1.7	50.0	4.0	4	0.05	12
1,5	1.5	2.4	50.0	4.0	4	0.05	12
2	2.0	3.0	54.0	6.0	4	0.10	12
2,5	2.5	4.5	54.0	6.0	4	0.10	12
3	3.0	5.0	54.0	6.0	4	0.10	12
4	4.0	8.0	54.0	6.0	4	0.10	12
5	5.0	9.0	54.0	6.0	4	0.15	12
6	6.0	10.0	54.0	6.0	4	0.15	0
8	8.0	12.0	58.0	8.0	4	0.20	0
10	10.0	16.0	66.0	10.0	4	0.20	0
12	12.0	19.0	73.0	12.0	4	0.25	0
16	16.0	25.0	82.0	16.0	4	0.30	0
20	20.0	32.0	92.0	20.0	4	0.30	0

M	Material	Strength (N/mm ²)	Vc = m/min	Vc = m/min	Vc = m/min	Vc = m/min	Materialgroup Factor fz / α	Materialgroup Factor ae ETC
STAINLESS STEEL								
1.1	ferritic/martensitic	<850	110	110	120	176	1	1
2.1	austenitic	<650	100	100	110	161	0.95	0.9
2.2	austenitic	<750	90	90	100	142	0.9	0.8
3.1	DUPLIX STEEL super austenitic	<1100	75	75	85	124	0.85	0.7
STEEL								
1.1-1.5	unalloyed	<1100	180	180	190	240	1	1
2.1-2.4	low alloyed	<1300	145	145	155	180	0.9	0.75
3.1-3.3	high alloyed	<1400	135	135	145	165	0.8	0.7
CASTINGS								
1.1	grey cast iron	<1000	200	200	210	240	0.9	0.8
TITANIUM								
2.1-2.3	pure/alloyed	<1000	50	50	55	100	0.7	0.5

ADVICE | The values marked in turquoise are side applications!
 All fz/α values in the table for material group 1.1, consider factors for the other groups!
 When helical, ramping and drilling use fz 50 % of the full slot.
 The specified values represent starting values for a solid clamping situation.
 To determine the hmax values, please use the provided formula.
 For material groups M2.2 and M3.1, the use of cooling lubricant is recommended!
 For coarser roughing operations and ETC operations, we recommend a Weldon in conjunction with a Weldon chuck.

Material M 1.1

D1 mm Ø	L2 mm	Immersion Angle α°	Full Slot			Side Milling			Finishing			ETC			
			fz (mm/Z)	ae = 1xD (mm)	ap = 1xD (mm)	fz (mm/Z)	ae = 0.3xD (mm)	ap (mm)	fz (mm/Z)	ae (mm)	ap (mm)	fz (mm/Z)	ae (mm)	ap (mm)	hmax (mm)
0.5	0.9	0.5°	0.007	0.5	0.5	0.01	0.15	L2max	0.005	0.1	L2max	0.014	0.08	L2max	0.0103
0.8	1.4	0.8°	0.008	0.8	0.8	0.012	0.24	L2max	0.006	0.1	L2max	0.018	0.1	L2max	0.0119
1	1.7	1°	0.012	1	1	0.018	0.3	L2max	0.01	0.1	L2max	0.024	0.12	L2max	0.0156
1.5	2.4	1°	0.015	1.5	1.5	0.022	0.45	L2max	0.012	0.1	L2max	0.028	0.18	L2max	0.0182
2	3	1.5°	0.017	2	2	0.024	0.6	L2max	0.014	0.2	L2max	0.033	0.25	L2max	0.0218
2.5	4.5	1.5°	0.019	2.5	2.5	0.028	0.75	L2max	0.016	0.2	L2max	0.04	0.32	L2max	0.0267
3	5	2°	0.02	3	3	0.03	0.9	L2max	0.018	0.2	L2max	0.05	0.4	L2max	0.034
4	8	3°	0.025	4	4	0.035	1.2	L2max	0.021	0.2	L2max	0.06	0.6	L2max	0.0428
5	9	4°	0.03	5	5	0.04	1.5	L2max	0.023	0.2	L2max	0.07	0.7	L2max	0.0486
6	10	5°	0.035	6	6	0.045	1.8	L2max	0.025	0.2	L2max	0.08	0.9	L2max	0.0571
8	12	8°	0.05	8	8	0.06	2.4	L2max	0.03	0.2	L2max	0.1	1.1	L2max	0.0689
10	16	10°	0.055	10	10	0.07	3	L2max	0.035	0.2	L2max	0.12	1.3	L2max	0.0807
12	19	15°	0.06	12	12	0.08	3.6	L2max	0.04	0.2	L2max	0.14	1.5	L2max	0.0926
16	25	20°	0.07	16	16	0.09	4.8	L2max	0.045	0.2	L2max	0.17	1.9	L2max	0.11
20	32	20°	0.09	20	20	0.11	6	L2max	0.05	0.2	L2max	0.21	2.1	L2max	0.1288

Cooling	
Tolerance	e8
Coating	AlphaNox Navy X

Strategy	ETC	HPC			
Application					
Features	HB	≠		1,5xD	R



Download Catalog Pages (PDF)

	Full Slot	Side Milling	Finishing	ETC	Materialgroup Factor fz / a	Materialgroup Factor ae ETC
--	-----------	--------------	-----------	-----	-----------------------------	-----------------------------

- Optimized microgeometry with higher vibration resistance and increased cutting edge stability
- Special unequal tooth pitch combined with variable helical pitch for smooth running

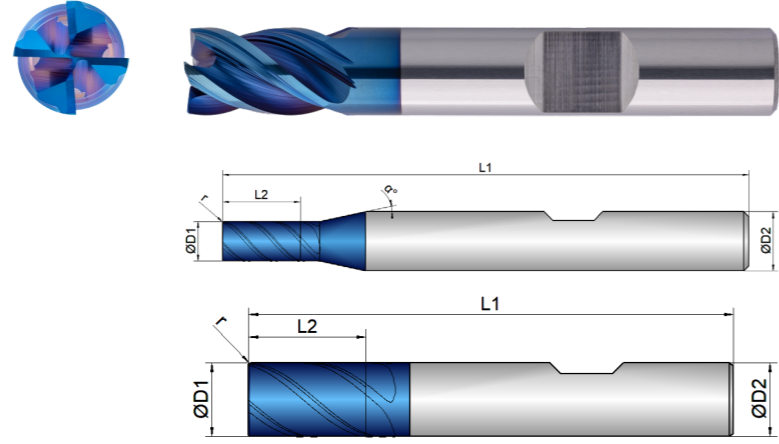

- Designed for maximum removal rate when milling with high radial depth of cut and in the full slot up to 1xD
- For process reliable ramping, helical immersion and diving (drilling) up to 1xD

- Update version and successor product for EXM1-M01-0114
- Universally applicable in all stainless steels

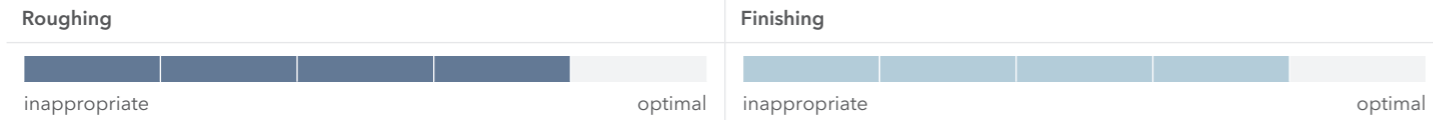

EXM1-M01-0214	D1 mm 	L2 mm 	L1 mm 	D2 mm 	z # 	r mm 		α °
3	3.0	5.0	54.0	6.0	4	0.10	40	12
4	4.0	8.0	54.0	6.0	4	0.10	40	12
5	5.0	9.0	54.0	6.0	4	0.15	40	12
6	6.0	10.0	54.0	6.0	4	0.15	40	0
8	8.0	12.0	58.0	8.0	4	0.20	40	0
10	10.0	16.0	66.0	10.0	4	0.20	40	0
12	12.0	19.0	73.0	12.0	4	0.25	40	0
16	16.0	25.0	82.0	16.0	4	0.30	40	0
20	20.0	32.0	92.0	20.0	4	0.30	40	0

Material	Strength (N/mm ²)	Vc = m/min	Vc = m/min	Vc = m/min	Vc = m/min	Materialgroup Factor fz / a	Materialgroup Factor ae ETC
M STAINLESS STEEL							
1.1 ferritic/martensitic	<850	110	110	120	176	1	1
2.1 austenitic	<650	100	100	110	161	0.95	0.9
2.2 austenitic	<750	90	90	100	142	0.9	0.8
3.1 DUPLEX STEEL super austenitic	<1100	75	75	85	124	0.85	0.7
P STEEL							
1.1-1.5 unalloyed	<1100	180	180	190	240	1	1
2.1-2.4 low alloyed	<1300	145	145	155	180	0.9	0.75
3.1-3.3 high alloyed	<1400	135	135	145	165	0.8	0.7
K CASTINGS							
1.1 grey cast iron	<1000	200	200	210	240	0.9	0.8
T TITANIUM							
2.1-2.3 pure/alloyed	<1000	50	50	55	100	0.7	0.5

ADVICE | The values marked in turquoise are side applications!
 All fz/a values in the table for material group 1.1, consider factors for the other groups!
 When helical, ramping and drilling use fz 50 % of the full slot.
 The specified values represent starting values for a solid clamping situation.
 To determine the hmax values, please use the provided formula.
 For material groups M2.2 and M3.1, the use of cooling lubricant is recommended!

Material M 1.1

D1 Ø	L2 mm	Immersion Angle α°	Full Slot			Side Milling			Finishing			ETC			
			fz (mm/Z)	ae = 1xD (mm)	ap = 1xD (mm)	fz (mm/Z)	ae = 0.3xD (mm)	ap (mm)	fz (mm/Z)	ae (mm)	ap (mm)	fz (mm/Z)	ae (mm)	ap (mm)	hmax (mm)
3	5	2°	0.02	3	3	0.03	0.9	L2max	0.018	0.2	L2max	0.05	0.4	L2max	0.034
4	8	3°	0.025	4	4	0.035	1.2	L2max	0.021	0.2	L2max	0.06	0.6	L2max	0.0428
5	9	4°	0.03	5	5	0.04	1.5	L2max	0.023	0.2	L2max	0.07	0.7	L2max	0.0486
6	10	5°	0.035	6	6	0.045	1.8	L2max	0.025	0.2	L2max	0.08	0.9	L2max	0.0571
8	12	8°	0.05	8	8	0.06	2.4	L2max	0.03	0.2	L2max	0.1	1.1	L2max	0.0689
10	16	10°	0.055	10	10	0.07	3	L2max	0.035	0.2	L2max	0.12	1.3	L2max	0.0807
12	19	15°	0.06	12	12	0.08	3.6	L2max	0.04	0.2	L2max	0.14	1.5	L2max	0.0926
16	25	20°	0.07	16	16	0.09	4.8	L2max	0.045	0.2	L2max	0.17	1.9	L2max	0.11
20	32	20°	0.09	20	20	0.11	6	L2max	0.05	0.2	L2max	0.21	2.1	L2max	0.1288

Cooling	
Tolerance	e8
Coating	AlphaNox Navy X

Strategy	ETC	HPC		
Application				
Features	HA	≠	2xD	

- Optimized microgeometry with higher vibration resistance and increased cutting edge stability
- Special unequal tooth pitch combined with variable helical pitch for smooth running
- Designed for maximum removal rate when milling with high radial depth of cut and in the full slot up to 1xD
- For process reliable ramping, helical immersion and diving (drilling) up to 1xD
- Update version and successor product for EXM1-M01-0123
- Universally applicable in all stainless steels

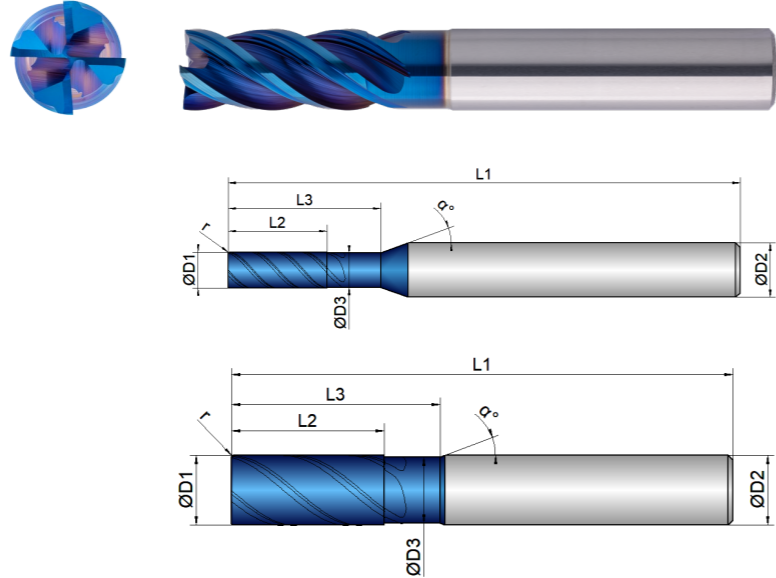

EXM1-M01-0223	D1 mm ∅	D3 mm ∅	L2 mm	L3 mm	L1 mm	D2 mm ∅	z #	r mm		α °
16	16.0	15.0	34.0	42.0	92.0	16.0	4	0.30	40	20
18	18.0	17.0	38.0	42.0	92.0	18.0	4	0.30	40	20
20	20.0	19.0	42.0	52.0	104.0	20.0	4	0.30	40	20
25	25.0	24.0	52.0	62.0	125.0	25.0	4	0.30	40	20

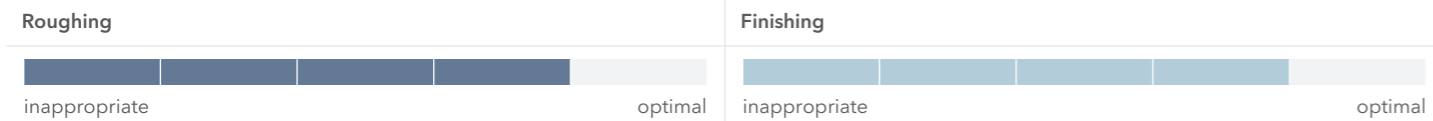

EXM1-M01-0223	D1 mm ∅	D3 mm ∅	L2 mm	L3 mm	L1 mm	D2 mm ∅	z #	r mm		α °
0,5	0.5	0.48	1.3	1.5	50.0	4.0	4	0.02	40	20
0,8	0.8	0.76	2.1	3.0	50.0	4.0	4	0.03	40	20
1	1.0	0.9	2.5	4.0	50.0	4.0	4	0.05	40	20
1,5	1.5	1.4	3.5	6.0	50.0	4.0	4	0.05	40	20
2	2.0	1.8	5.0	8.0	57.0	6.0	4	0.10	40	20
2,5	2.5	2.3	6.0	10.0	57.0	6.0	4	0.10	40	20
3	3.0	2.8	8.0	13.0	57.0	6.0	4	0.10	40	20
4	4.0	3.7	11.0	17.0	57.0	6.0	4	0.10	40	20
5	5.0	4.7	13.0	20.0	57.0	6.0	4	0.15	40	20
6	6.0	5.5	13.0	20.0	57.0	6.0	4	0.15	40	20
7	7.0	6.5	16.0	25.0	63.0	8.0	4	0.20	40	20
8	8.0	7.5	19.0	25.0	63.0	8.0	4	0.20	40	20
10	10.0	9.5	22.0	30.0	72.0	10.0	4	0.20	40	20
12	12.0	11.0	26.0	36.0	83.0	12.0	4	0.25	40	20
14	14.0	13.0	30.0	36.0	83.0	14.0	4	0.25	40	20



Download Catalog Pages (PDF)

Material	Strength (N/mm ²)	Full Slot	Side Milling	Finishing	ETC	Materialgroup Factor fz / a	Materialgroup Factor ae ETC
		Vc = m/min	Vc = m/min	Vc = m/min	Vc = m/min		
M STAINLESS STEEL							
1.1 ferritic/martensitic	<850	110	110	120	176	1	1
2.1 austenitic	<650	100	100	110	161	0.95	0.9
2.2 austenitic	<750	90	90	100	142	0.9	0.8
3.1 DUPLEX STEEL super austenitic	<1100	75	75	85	124	0.85	0.7
P STEEL							
1.1-1.5 unalloyed	<1100	180	180	190	240	1	1
2.1-2.4 low alloyed	<1300	145	145	155	180	0.9	0.75
3.1-3.3 high alloyed	<1400	135	135	145	165	0.8	0.7
K CASTINGS							
1.1 grey cast iron	<1000	200	200	210	240	0.9	0.8
T TITANIUM							
2.1-2.3 pure/alloyed	<1000	50	50	55	100	0.7	0.5

ADVICE | The values marked in turquoise are side applications!
 All fz/a values in the table for material group 1.1, consider factors for the other groups!
 When helical, ramping and drilling use fz 50 % of the full slot.
 The specified values represent starting values for a solid clamping situation.
 To determine the hmax values, please use the provided formula.
 For material groups M2.2 and M3.1, the use of cooling lubricant is recommended!
 For coarser roughing operations and ETC operations, we recommend a Weldon in conjunction with a Weldon chuck.

Material M 1.1

D1	L2	Immersion Angle	Full Slot			Side Milling			Finishing			ETC			
			fz	ae = 1xD	ap = 1xD	fz	ae = 0.3xD	ap	fz	ae	ap	fz	ae	ap	hmax
Ø	mm	α°	(mm/Z)	(mm)	(mm)	(mm/Z)	(mm)	(mm)	(mm/Z)	(mm)	(mm)	(mm/Z)	(mm)	(mm)	(mm)
0.5	1.3	0.5°	0.007	0.5	0.5	0.01	0.15	L2max	0.005	0.1	L2max	0.014	0.08	L2max	0.0103
0.8	2.1	0.8°	0.008	0.8	0.8	0.012	0.24	L2max	0.006	0.1	L2max	0.018	0.1	L2max	0.0119
1	2.5	1°	0.012	1	1	0.018	0.3	L2max	0.01	0.1	L2max	0.024	0.12	L2max	0.0156
1.5	3.5	1°	0.015	1.5	1.5	0.022	0.45	L2max	0.012	0.1	L2max	0.028	0.18	L2max	0.0182
2	5	1.5°	0.017	2	2	0.024	0.6	L2max	0.014	0.2	L2max	0.033	0.25	L2max	0.0218
2.5	6	1.5°	0.019	2.5	2.5	0.028	0.75	L2max	0.016	0.2	L2max	0.04	0.32	L2max	0.0267
3	8	2°	0.02	3	3	0.03	0.9	L2max	0.018	0.2	L2max	0.05	0.4	L2max	0.034
4	11	3°	0.025	4	4	0.035	1.2	L2max	0.021	0.2	L2max	0.06	0.6	L2max	0.0428
5	13	4°	0.03	5	5	0.04	1.5	L2max	0.023	0.2	L2max	0.07	0.7	L2max	0.0486
6	13	5°	0.035	6	6	0.045	1.8	L2max	0.025	0.2	L2max	0.08	0.9	L2max	0.0571
7	16	6°	0.04	7	7	0.05	2.1	L2max	0.025	0.2	L2max	0.09	1	L2max	0.063
8	19	8°	0.05	8	8	0.06	2.4	L2max	0.03	0.2	L2max	0.1	1.1	L2max	0.0689
10	22	10°	0.055	10	10	0.07	3	L2max	0.035	0.2	L2max	0.12	1.3	L2max	0.0807
12	26	15°	0.06	12	12	0.08	3.6	L2max	0.04	0.2	L2max	0.14	1.5	L2max	0.0926
14	30	15°	0.065	14	14	0.085	4.2	L2max	0.04	0.2	L2max	0.15	1.7	L2max	0.098
16	34	20°	0.07	16	16	0.09	4.8	L2max	0.045	0.2	L2max	0.17	1.9	L2max	0.11
18	38	20°	0.08	18	18	0.1	5.4	L2max	0.045	0.2	L2max	0.19	2	L2max	0.1194
20	42	20°	0.09	20	20	0.11	6	L2max	0.05	0.2	L2max	0.21	2.1	L2max	0.1288
25	52	20°	0.1	25	25	0.12	7.5	L2max	0.055	0.2	L2max	0.23	2.4	L2max	0.1355



STILL CAN'T FIND A SUITABLE MILLING CUTTER?

No problem - simply customize an existing tool. Using our configurator for special milling cutters, you can customize existing tools to your needs in an instant or create your own tools based on predefined types.



WE WILL RESPOND TO ALL REQUESTS SUBMITTED VIA THE CONFIGURATOR WITHIN ONE WORKING DAY AT THE LATEST

Cooling	
Tolerance	e8
Coating	AlphaNox Navy X

Strategy	ETC	HPC				
Application						
Features	HB	≠	2xD		R	

- Optimized microgeometry with higher vibration resistance and increased cutting edge stability
- Special unequal tooth pitch combined with variable helical pitch for smooth running
- Designed for maximum removal rate when milling with high radial depth of cut and in the full slot up to 1xD
- For process reliable ramping, helical immersion and diving (drilling) up to 1xD
- Update version and successor product for EXM1-M01-0124
- Universally applicable in all stainless steels

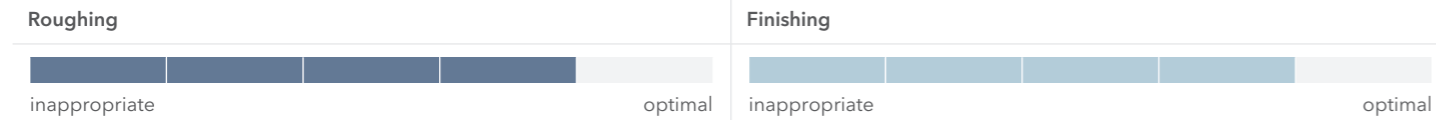
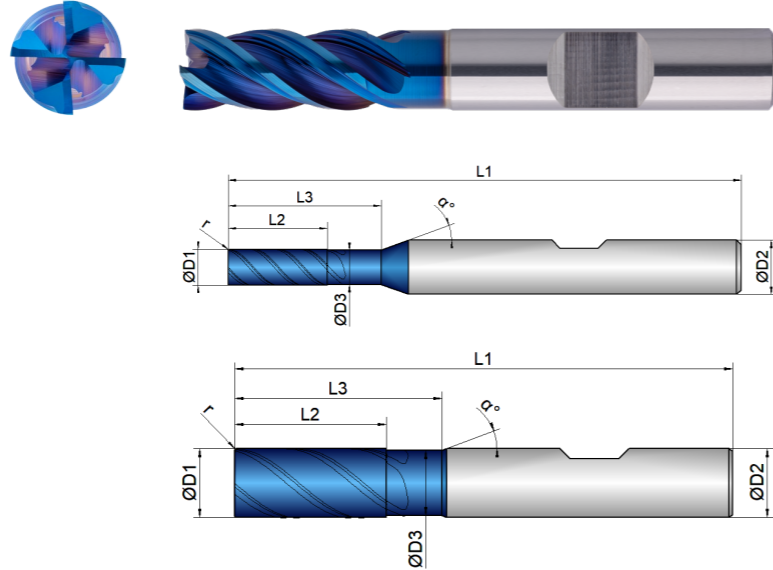

EXM1-M01-0224	D1	D3	L2	L3	L1	D2	z	r	α
	mm	mm	mm	mm	mm	mm	#	mm	°
2	2.0	1.8	5.0	8.0	57.0	6.0	4	0.10	40
2,5	2.5	2.3	6.0	10.0	57.0	6.0	4	0.10	40
3	3.0	2.8	8.0	13.0	57.0	6.0	4	0.10	40
4	4.0	3.7	11.0	17.0	57.0	6.0	4	0.10	40
5	5.0	4.7	13.0	20.0	57.0	6.0	4	0.15	40
6	6.0	5.5	13.0	20.0	57.0	6.0	4	0.15	40
7	7.0	6.5	16.0	25.0	63.0	8.0	4	0.20	40
8	8.0	7.5	19.0	25.0	63.0	8.0	4	0.20	40
10	10.0	9.5	22.0	30.0	72.0	10.0	4	0.20	40
12	12.0	11.0	26.0	36.0	83.0	12.0	4	0.25	40
14	14.0	13.0	30.0	36.0	83.0	14.0	4	0.25	40
16	16.0	15.0	34.0	42.0	92.0	16.0	4	0.30	40
18	18.0	17.0	38.0	42.0	92.0	18.0	4	0.30	40
20	20.0	19.0	42.0	52.0	104.0	20.0	4	0.30	40
25	25.0	24.0	52.0	62.0	125.0	25.0	4	0.30	40



Download Catalog Pages (PDF)

Material	Strength (N/mm ²)	Full Slot	Side Milling	Finishing	ETC	Materialgroup Factor fz / a	Materialgroup Factor ae ETC
M STAINLESS STEEL		Vc = m/min	Vc = m/min	Vc = m/min	Vc = m/min		
1.1 ferritic/martensitic	<850	110	110	120	176	1	1
2.1 austenitic	<650	100	100	110	161	0.95	0.9
2.2 austenitic	<750	90	90	100	142	0.9	0.8
3.1 DUPLEX STEEL super austenitic	<1100	75	75	85	124	0.85	0.7
P STEEL		Vc = m/min	Vc = m/min	Vc = m/min	Vc = m/min		
1.1-1.5 unalloyed	<1100	180	180	190	240	1	1
2.1-2.4 low alloyed	<1300	145	145	155	180	0.9	0.75
3.1-3.3 high alloyed	<1400	135	135	145	165	0.8	0.7
K CASTINGS		Vc = m/min	Vc = m/min	Vc = m/min	Vc = m/min		
1.1 grey cast iron	<1000	200	200	210	240	0.9	0.8
T TITANIUM		Vc = m/min	Vc = m/min	Vc = m/min	Vc = m/min		
2.1-2.3 pure/alloyed	<1000	50	50	55	100	0.7	0.5

ADVICE | The values marked in turquoise are side applications! All fz/a values in the table for material group 1.1, consider factors for the other groups! When helical, ramping and drilling use fz 50 % of the full slot. The specified values represent starting values for a solid clamping situation. To determine the hmax values, please use the provided formula. For material groups M2.2 and M3.1, the use of cooling lubricant is recommended!

Material M 1.1

Ø	L2	Immersion Angle	Full Slot			Side Milling			Finishing			ETC				
			fz	ae = 1xD	ap = 1xD	fz	ae = 0.3xD	ap	fz	ae	ap	fz	ae	ap	hmax	
mm	mm	α°	(mm/Z)	(mm)	(mm)	(mm/Z)	(mm)	(mm)	(mm/Z)	(mm)	(mm)	(mm/Z)	(mm)	(mm)	(mm)	(mm)
2	5	1.5°	0.017	2	2	0.024	0.6	L2max	0.014	0.2	L2max	0.033	0.25	L2max	0.0218	
2.5	6	1.5°	0.019	2.5	2.5	0.028	0.75	L2max	0.016	0.2	L2max	0.04	0.32	L2max	0.0267	
3	8	2°	0.02	3	3	0.03	0.9	L2max	0.018	0.2	L2max	0.05	0.4	L2max	0.034	
4	11	3°	0.025	4	4	0.035	1.2	L2max	0.021	0.2	L2max	0.06	0.6	L2max	0.0428	
5	13	4°	0.03	5	5	0.04	1.5	L2max	0.023	0.2	L2max	0.07	0.7	L2max	0.0486	
6	13	5°	0.035	6	6	0.045	1.8	L2max	0.025	0.2	L2max	0.08	0.9	L2max	0.0571	
7	16	6°	0.04	7	7	0.05	2.1	L2max	0.025	0.2	L2max	0.09	1	L2max	0.063	
8	19	8°	0.05	8	8	0.06	2.4	L2max	0.03	0.2	L2max	0.1	1.1	L2max	0.0689	
10	22	10°	0.055	10	10	0.07	3	L2max	0.035	0.2	L2max	0.12	1.3	L2max	0.0807	
12	26	15°	0.06	12	12	0.08	3.6	L2max	0.04	0.2	L2max	0.14	1.5	L2max	0.0926	
14	30	15°	0.065	14	14	0.085	4.2	L2max	0.04	0.2	L2max	0.15	1.7	L2max	0.098	
16	34	20°	0.07	16	16	0.09	4.8	L2max	0.045	0.2	L2max	0.17	1.9	L2max	0.11	
18	38	20°	0.08	18	18	0.1	5.4	L2max	0.045	0.2	L2max	0.19	2	L2max	0.1194	
20	42	20°	0.09	20	20	0.11	6	L2max	0.05	0.2	L2max	0.21	2.1	L2max	0.1288	
25	52	20°	0.1	25	25	0.12	7.5	L2max	0.055	0.2	L2max	0.23	2.4	L2max	0.1355	

Cooling	
Tolerance	e8
Coating	AlphaNox Navy X

Strategy	ETC	HPC				
Application						
Features	HA	≠	3xD			



Download Catalog Pages (PDF)

Material	Strength (N/mm ²)	Side Milling	Finishing	ETC	Materialgroup Factor fz / a	Materialgroup Factor ae ETC
----------	-------------------------------	--------------	-----------	-----	-----------------------------	-----------------------------

- Optimized microgeometry with higher vibration resistance and increased cutting edge stability
- Special unequal tooth pitch combined with variable helical pitch for smooth running
- Designed for maximum removal rate when milling with high radial depth of cut and for trochoidal milling
- For process reliable ramping, helical immersion and diving (drilling) up to 1xD
- Universally applicable in all stainless steels

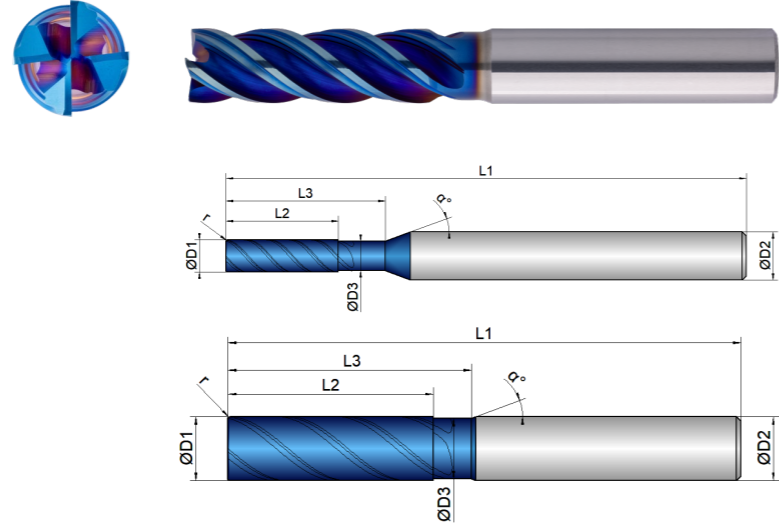

Roughing	Finishing
inappropriate	optimal

EXM1-M01-0323	D1	D3	L2	L3	L1	D2	z	r		α
	mm \varnothing	mm \varnothing	mm	mm	mm	mm \varnothing	#	mm	R	$^\circ$
0,5	0.5	0.48	2.0	2.5	50.0	4.0	4	0.02	40	20
0,8	0.8	0.76	3.0	4.0	50.0	4.0	4	0.03	40	20
1	1.0	0.9	3.5	5.0	50.0	4.0	4	0.05	40	20
1,5	1.5	1.4	5.0	8.0	50.0	4.0	4	0.05	40	20
2	2.0	1.8	7.0	10.0	65.0	6.0	4	0.10	40	20
2,5	2.5	2.3	9.0	12.0	65.0	6.0	4	0.10	40	20
3	3.0	2.8	11.0	15.0	65.0	6.0	4	0.10	40	20
4	4.0	3.7	14.0	20.0	65.0	6.0	4	0.10	40	20
5	5.0	4.7	16.0	26.0	65.0	6.0	4	0.15	40	20
6	6.0	5.5	19.0	26.0	65.0	6.0	4	0.15	40	20
8	8.0	7.5	26.0	32.0	70.0	8.0	4	0.20	40	20
10	10.0	9.5	32.0	38.0	80.0	10.0	4	0.20	40	20
12	12.0	11.0	38.0	46.0	93.0	12.0	4	0.25	40	20
16	16.0	15.0	50.0	60.0	110.0	16.0	4	0.30	40	20
20	20.0	19.0	62.0	74.0	125.0	20.0	4	0.30	40	20

M	Material	Strength (N/mm ²)	Vc = m/min	Vc = m/min	Vc = m/min	Materialgroup Factor fz / a	Materialgroup Factor ae ETC
STAINLESS STEEL							
1.1	ferritic/martensitic	<850	105	115	167	1	1
2.1	austenitic	<650	95	105	153	0.95	0.9
2.2	austenitic	<750	86	95	135	0.9	0.8
3.1	DUPLIX STEEL super austenitic	<1100	72	80	118	0.85	0.7
STEEL							
1.1-1.5	unalloyed	<1100	172	180	228	1	1
2.1-2.4	low alloyed	<1300	138	148	171	0.9	0.75
3.1-3.3	high alloyed	<1400	128	138	156	0.8	0.7
CASTINGS							
1.1	grey cast iron	<1000	190	200	228	0.9	0.8
TITANIUM							
2.1-2.3	pure/alloyed	<1000	48	52	95	0.7	0.5

ADVICE | The values marked in turquoise are side applications!
 All fz/a values in the table for material group 1.1, consider factors for the other groups!
 When helical, reduce fz by 50 %.
 The specified values represent starting values for a solid clamping situation.
 For material groups M2.2 and M3.1, the use of cooling lubricant is recommended!
 For coarser roughing operations and ETC operations, we recommend a Weldon in conjunction with a Weldon chuck.

Material M 1.1

D1	L2	Immersion Angle	Side Milling			Finishing			ETC			
			fz (mm/Z)	ae = 0.2xD (mm)	ap (mm)	fz (mm/Z)	ae (mm)	ap (mm)	fz (mm/Z)	ae (mm)	ap (mm)	hmax (mm)
0.5	2	0.4°	0.008	0.1	L2max	0.006	0.1	L2max	0.012	0.05	L2max	0.0072
0.8	3	0.6°	0.01	0.16	L2max	0.008	0.1	L2max	0.015	0.08	L2max	0.009
1	3.5	0.8°	0.015	0.2	L2max	0.01	0.1	L2max	0.02	0.1	L2max	0.012
1.5	5	0.8°	0.018	0.3	L2max	0.012	0.1	L2max	0.024	0.15	L2max	0.0144
2	7	1.2°	0.02	0.4	L2max	0.014	0.2	L2max	0.028	0.2	L2max	0.0168
2.5	9	1.2°	0.022	0.5	L2max	0.015	0.2	L2max	0.034	0.25	L2max	0.0204
3	11	1.5°	0.026	0.6	L2max	0.016	0.2	L2max	0.04	0.3	L2max	0.024
4	14	2°	0.028	0.8	L2max	0.017	0.2	L2max	0.048	0.4	L2max	0.0288
5	16	3°	0.035	1	L2max	0.018	0.2	L2max	0.055	0.5	L2max	0.033
6	19	4°	0.04	1.2	L2max	0.023	0.2	L2max	0.065	0.6	L2max	0.039
8	26	6°	0.055	1.6	L2max	0.027	0.2	L2max	0.08	0.8	L2max	0.048
10	32	8°	0.064	2	L2max	0.032	0.2	L2max	0.096	1	L2max	0.0576
12	38	12°	0.072	2.4	L2max	0.036	0.2	L2max	0.11	1.2	L2max	0.066
16	50	15°	0.08	3.2	L2max	0.04	0.2	L2max	0.135	1.6	L2max	0.081
20	62	15°	0.1	4	L2max	0.045	0.2	L2max	0.168	2	L2max	0.1008

Cooling	
Tolerance	e8
Coating	AlphaNox Navy X

Strategy	ETC	HPC				
Application						
Features	HB	≠	3xD			



Download Catalog Pages (PDF)

Material	Strength (N/mm ²)	Side Milling	Finishing	ETC	Materialgroup Factor fz / a	Materialgroup Factor ae ETC
----------	-------------------------------	--------------	-----------	-----	-----------------------------	-----------------------------

- Optimized microgeometry with higher vibration resistance and increased cutting edge stability
- Special unequal tooth pitch combined with variable helical pitch for smooth running
- Designed for maximum removal rate when milling with high radial depth of cut and for trochoidal milling
- For process reliable ramping, helical immersion and diving (drilling) up to 1xD
- Universally applicable in all stainless steels

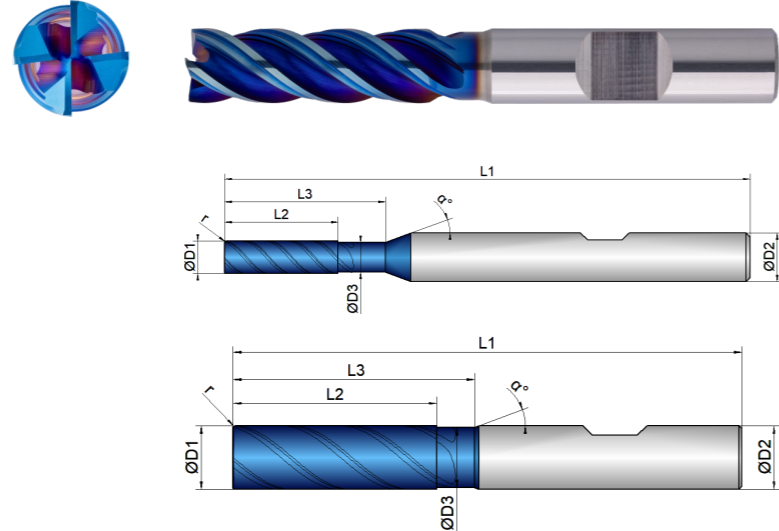

Roughing	Finishing
inappropriate	inappropriate
optimal	optimal

EXM1-M01-0324	D1	D3	L2	L3	L1	D2	z	r		
	mm	mm	mm	mm	mm	mm	#	mm		
3	3.0	2.8	11.0	15.0	65.0	6.0	4	0.10	40	20
4	4.0	3.7	14.0	20.0	65.0	6.0	4	0.10	40	20
5	5.0	4.7	16.0	26.0	65.0	6.0	4	0.15	40	20
6	6.0	5.5	19.0	26.0	65.0	6.0	4	0.15	40	20
8	8.0	7.5	26.0	32.0	70.0	8.0	4	0.20	40	20
10	10.0	9.5	32.0	38.0	80.0	10.0	4	0.20	40	20
12	12.0	11.0	38.0	46.0	93.0	12.0	4	0.25	40	20
16	16.0	15.0	50.0	60.0	110.0	16.0	4	0.30	40	20
20	20.0	19.0	62.0	74.0	125.0	20.0	4	0.30	40	20

M	STAINLESS STEEL		Vc = m/min	Vc = m/min	Vc = m/min		
1.1	ferritic/martensitic	<850	105	115	167	1	1
2.1	austenitic	<650	95	105	153	0.95	0.9
2.2	austenitic	<750	86	95	135	0.9	0.8
3.1	DUPLIX STEEL super austenitic	<1100	72	80	118	0.85	0.7
P	STEEL		Vc = m/min	Vc = m/min	Vc = m/min		
1.1-1.5	unalloyed	<1100	172	180	228	1	1
2.1-2.4	low alloyed	<1300	138	148	171	0.9	0.75
3.1-3.3	high alloyed	<1400	128	138	156	0.8	0.7
K	CASTINGS		Vc = m/min	Vc = m/min	Vc = m/min		
1.1	grey cast iron	<1000	190	200	228	0.9	0.8
T	TITANIUM		Vc = m/min	Vc = m/min	Vc = m/min		
2.1-2.3	pure/alloyed	<1000	48	52	95	0.7	0.5

ADVICE | The values marked in turquoise are side applications!
 All fz/a values in the table for material group 1.1, consider factors for the other groups!
 When helical, reduce fz by 50 %.
 The specified values represent starting values for a solid clamping situation.
 For material groups M2.2 and M3.1, the use of cooling lubricant is recommended!

Material M 1.1

D1	L2	Immersion Angle	Side Milling			Finishing			ETC				
			fz	ae = 0.2xD	ap	fz	ae	ap	fz	ae	ap	hmax	
Ø	mm	α°	(mm/Z)	(mm)	(mm)	(mm/Z)	(mm)	(mm)	(mm/Z)	(mm)	(mm)	(mm)	(mm)
3	11	1,5°	0,026	0,6	L2max	0,016	0,2	L2max	0,04	0,3	L2max	0,024	
4	14	2°	0,028	0,8	L2max	0,017	0,2	L2max	0,048	0,4	L2max	0,0288	
5	16	3°	0,035	1	L2max	0,018	0,2	L2max	0,055	0,5	L2max	0,033	
6	19	4°	0,04	1,2	L2max	0,023	0,2	L2max	0,065	0,6	L2max	0,039	
8	26	6°	0,055	1,6	L2max	0,027	0,2	L2max	0,08	0,8	L2max	0,048	
10	32	8°	0,064	2	L2max	0,032	0,2	L2max	0,096	1	L2max	0,0576	
12	38	12°	0,072	2,4	L2max	0,036	0,2	L2max	0,11	1,2	L2max	0,066	
16	50	15°	0,08	3,2	L2max	0,04	0,2	L2max	0,135	1,6	L2max	0,081	
20	62	15°	0,1	4	L2max	0,045	0,2	L2max	0,168	2	L2max	0,1008	

Cooling	
Tolerance	e8
Coating	AlphaNox Navy X

Strategy	HPC	
Application		
Features	HA \neq 2xD	

- Optimized microgeometry with higher vibration resistance and increased cutting edge stability
- Special unequal tooth pitch combined with variable helical pitch for smooth running
- Designed for high stability with particularly long projection lengths
- Overlong version for deepest cavities
- Universally applicable in all stainless steels

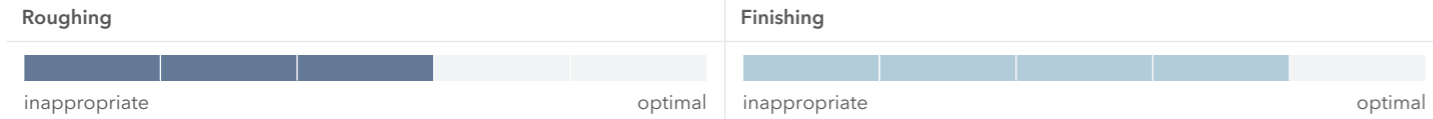
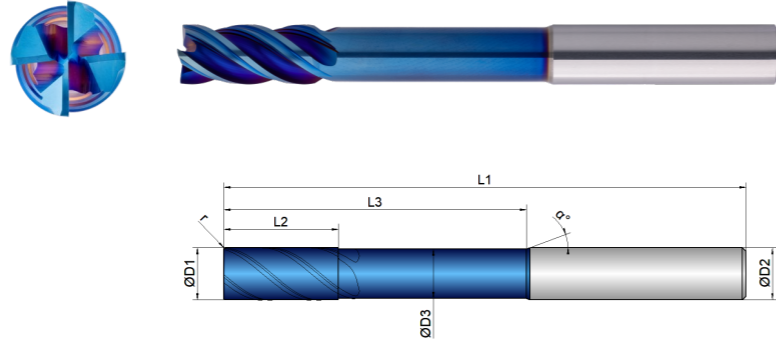

EXM1-M01-0423	D1	D3	L2	L3	L1	D2	z	r	α
	mm \varnothing	mm \varnothing	mm	mm	mm	mm \varnothing	#	mm	$^{\circ}$
6	6.0	5.5	13.0	42.0	83.0	6.0	4	0.15	40
8	8.0	7.5	19.0	52.0	100.0	8.0	4	0.20	40
10	10.0	9.5	22.0	58.0	100.0	10.0	4	0.20	40
12	12.0	11.0	26.0	72.0	119.0	12.0	4	0.25	40
16	16.0	15.0	34.0	94.0	150.0	16.0	4	0.30	40
20	20.0	19.0	42.0	98.0	150.0	20.0	4	0.30	40



Download Catalog Pages (PDF)

Material	Strength (N/mm ²)	Side Milling	Finishing	Materialgroup Factor fz
		Vc = m/min	Vc = m/min	
M STAINLESS STEEL				
1.1 ferritic/martensitic	<850	85	95	1
2.1 austenitic	<650	75	85	0.95
2.2 austenitic	<750	65	75	0.9
3.1 DUPLEX STEEL super austenitic	<1100	55	65	0.85
P STEEL				
1.1-1.5 unalloyed	<1100	95	110	1
2.1-2.4 low alloyed	<1300	80	100	0.9
3.1-3.3 high alloyed	<1400	70	90	0.8
K CASTINGS				
1.1 grey cast iron	<1000	110	130	0.9
T TITANIUM				
2.1-2.3 pure/alloyed	<1000	35	40	0.7

ADVICE | The values marked in turquoise are side applications!
 All fz/a values in the table for material group 1.1, consider factors for the other groups!
 When helical, reduce fz by 50%.
 The specified values represent starting values for a solid clamping situation.
 For material groups M2.2 and M3.1, the use of cooling lubricant is recommended!

Material M 1.1

D1	L2	Immersion Angle	Side Milling			Finishing		
			fz (mm/Z)	ae = 0.1xD (mm)	ap (mm)	fz (mm/Z)	ae (mm)	ap (mm)
6	13	0.3°	0.03	0.6	L2max	0.02	0.2	L2max
8	19	0.4°	0.04	0.8	L2max	0.025	0.2	L2max
10	22	0.6°	0.05	1	L2max	0.03	0.2	L2max
12	26	0.8°	0.06	1.2	L2max	0.035	0.2	L2max
16	34	1°	0.07	1.6	L2max	0.04	0.2	L2max
20	42	1.2°	0.085	2	L2max	0.045	0.2	L2max

Cooling	
Tolerance	e8
Coating	AlphaNox Navy X

Strategy	HPC		
Application			Expert
Features	HB	≠	2xD



Download Catalog Pages (PDF)

Material	Strength (N/mm ²)	Side Milling	Finishing	Materialgroup Factor fz
----------	-------------------------------	--------------	-----------	-------------------------

- Optimized microgeometry with higher vibration resistance and increased cutting edge stability
- Special unequal tooth pitch combined with variable helical pitch for smooth running
- Designed for high stability with particularly long projection lengths
- Overlong version for deepest cavities
- Universally applicable in all stainless steels

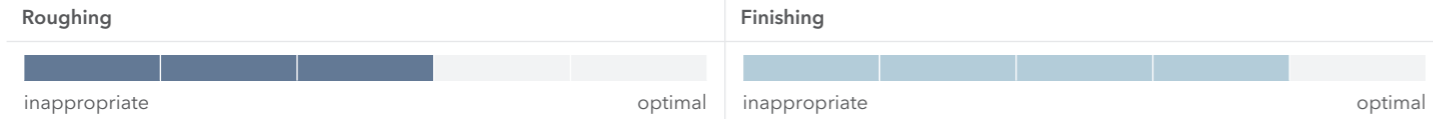
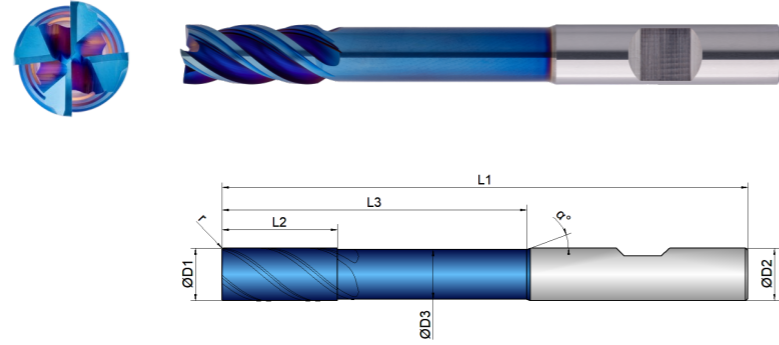

EXM1-M01-0424	D1	D3	L2	L3	L1	D2	z	r	α
	mm \varnothing	mm \varnothing	mm	mm	mm	mm \varnothing	#	mm	°
6	6.0	5.5	13.0	42.0	83.0	6.0	4	0.15	20
8	8.0	7.5	19.0	52.0	100.0	8.0	4	0.20	20
10	10.0	9.5	22.0	58.0	100.0	10.0	4	0.20	20
12	12.0	11.0	26.0	72.0	119.0	12.0	4	0.25	20
16	16.0	15.0	34.0	94.0	150.0	16.0	4	0.30	20
20	20.0	19.0	42.0	98.0	150.0	20.0	4	0.30	20

M	Material	Strength (N/mm ²)	Vc = m/min	Vc = m/min	Materialgroup Factor fz
1.1	ferritic/martensitic	<850	85	95	1
2.1	austenitic	<650	75	85	0.95
2.2	austenitic	<750	65	75	0.9
3.1	DUPLIX STEEL super austenitic	<1100	55	65	0.85
P	STEEL		Vc = m/min	Vc = m/min	
1.1-1.5	unalloyed	<1100	95	110	1
2.1-2.4	low alloyed	<1300	80	100	0.9
3.1-3.3	high alloyed	<1400	70	90	0.8
K	CASTINGS		Vc = m/min	Vc = m/min	
1.1	grey cast iron	<1000	110	130	0.9
T	TITANIUM		Vc = m/min	Vc = m/min	
2.1-2.3	pure/alloyed	<1000	35	40	0.7

ADVICE | The values marked in turquoise are side applications! All fz/a values in the table for material group 1.1, consider factors for the other groups! When helical, reduce fz by 50 %. The specified values represent starting values for a solid clamping situation. For material groups M2.2 and M3.1, the use of cooling lubricant is recommended!

Material M 1.1

D1	L2	Immersion Angle	Side Milling			Finishing		
			fz	ae = 0.1xD	ap	fz	ae	ap
\varnothing	mm	α°	(mm/Z)	(mm)	(mm)	(mm/Z)	(mm)	(mm)
6	13	0.3°	0.03	0.6	L2max	0.02	0.2	L2max
8	19	0.4°	0.04	0.8	L2max	0.025	0.2	L2max
10	22	0.6°	0.05	1	L2max	0.03	0.2	L2max
12	26	0.8°	0.06	1.2	L2max	0.035	0.2	L2max
16	34	1°	0.07	1.6	L2max	0.04	0.2	L2max
20	42	1.2°	0.085	2	L2max	0.045	0.2	L2max

Cooling	
Tolerance	e8
Coating	AlphaNox Navy X

Strategy	ETC	HPC	
Application			
Features	HA	≠	2xD



Download Catalog Pages (PDF)

Material	Strength (N/mm ²)	Full Slot	Side Milling	Finishing	ETC	Materialgroup Factor fz / a	Materialgroup Factor ae ETC
----------	-------------------------------	-----------	--------------	-----------	-----	-----------------------------	-----------------------------

- Optimized microgeometry with higher vibration resistance and increased cutting edge stability
- Special unequal tooth pitch combined with variable helical pitch for smooth running
- Designed for maximum removal rate when milling with high radial depth of cut and in the full slot up to 1xD
- For process reliable ramping, helical immersion and diving (drilling) up to 1xD
- New version with main focus on all CrNi steels (M1.1 / M2.1, V2A)
- Specially designed to withstand the varying additions of CrNi steels

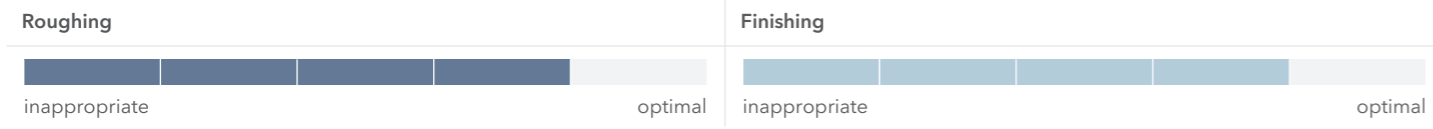
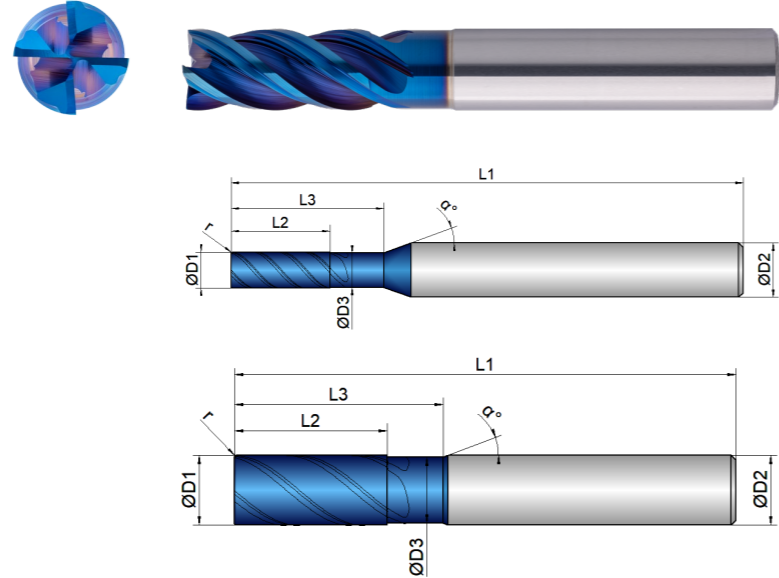

EXM1-M01-0523	D1	D3	L2	L3	L1	D2	z	r	α
	mm	mm	mm	mm	mm	mm	#	mm	°
2	2.0	1.8	5.0	8.0	57.0	6.0	4	0.10	40
3	3.0	2.8	8.0	13.0	57.0	6.0	4	0.10	40
4	4.0	3.7	11.0	17.0	57.0	6.0	4	0.10	40
5	5.0	4.7	13.0	20.0	57.0	6.0	4	0.15	40
6	6.0	5.5	13.0	20.0	57.0	6.0	4	0.15	40
7	7.0	6.5	16.0	25.0	63.0	8.0	4	0.20	40
8	8.0	7.5	19.0	25.0	63.0	8.0	4	0.20	40
10	10.0	9.5	22.0	30.0	72.0	10.0	4	0.20	40
12	12.0	11.0	26.0	36.0	83.0	12.0	4	0.25	40
14	14.0	13.0	30.0	36.0	83.0	14.0	4	0.25	40
16	16.0	15.0	34.0	42.0	92.0	16.0	4	0.30	40
18	18.0	17.0	38.0	42.0	92.0	18.0	4	0.30	40
20	20.0	19.0	42.0	52.0	104.0	20.0	4	0.30	40
25	25.0	24.0	52.0	62.0	125.0	25.0	4	0.30	40

M	Material	Strength (N/mm ²)	Vc = m/min	Vc = m/min	Vc = m/min	Vc = m/min	Materialgroup Factor fz / a	Materialgroup Factor ae ETC
1.1	ferritic/martensitic	<850	110	110	120	176	1	1
2.1	austenitic	<650	100	100	110	161	0.95	0.9
2.2	austenitic	<750	90	90	100	142	0.9	0.8
3.1	DUPLIX STEEL super austenitic	<1100	75	75	85	124	0.85	0.7
P	STEEL		Vc = m/min	Vc = m/min	Vc = m/min	Vc = m/min		
1.1-1.5	unalloyed	<1100	180	180	190	240	1	1
2.1-2.4	low alloyed	<1300	145	145	155	180	0.9	0.75
3.1-3.3	high alloyed	<1400	135	135	145	165	0.8	0.7
K	CASTINGS		Vc = m/min	Vc = m/min	Vc = m/min	Vc = m/min		
1.1	grey cast iron	<1000	200	200	210	240	0.9	0.8
T	TITANIUM		Vc = m/min	Vc = m/min	Vc = m/min	Vc = m/min		
2.1-2.3	pure/alloyed	<1000	50	50	55	100	0.7	0.5

ADVICE | The values marked in turquoise are side applications! All fz/a values in the table for material group 1.1, consider factors for the other groups! When helical, ramping and drilling use fz 50 % of the full slot. The specified values represent starting values for a solid clamping situation. To determine the hmax values, please use the provided formula. For material groups M2.2 and M3.1, the use of cooling lubricant is recommended! For coarser roughing operations and ETC operations, we recommend a Weldon in conjunction with a Weldon chuck.

Material M 1.1

D1	L2	Immersion Angle	Full Slot			Side Milling			Finishing			ETC				
			fz	ae = 1xD	ap = 1xD	fz	ae = 0.3xD	ap	fz	ae	ap	fz	ae	ap	hmax	
Ø	mm	α°	(mm/Z)	(mm)	(mm)	(mm/Z)	(mm)	(mm)	(mm/Z)	(mm)	(mm)	(mm/Z)	(mm)	(mm)	(mm)	(mm)
2	5	1.5°	0.017	2	2	0.024	0.6	L2max	0.014	0.2	L2max	0.033	0.25	L2max	0.0218	
3	8	2°	0.02	3	3	0.03	0.9	L2max	0.018	0.2	L2max	0.05	0.4	L2max	0.034	
4	11	3°	0.025	4	4	0.035	1.2	L2max	0.021	0.2	L2max	0.06	0.6	L2max	0.0428	
5	13	4°	0.03	5	5	0.04	1.5	L2max	0.023	0.2	L2max	0.07	0.7	L2max	0.0486	
6	13	5°	0.035	6	6	0.045	1.8	L2max	0.025	0.2	L2max	0.08	0.9	L2max	0.0571	
7	16	6°	0.04	7	7	0.05	2.1	L2max	0.025	0.2	L2max	0.09	1	L2max	0.063	
8	19	8°	0.05	8	8	0.06	2.4	L2max	0.03	0.2	L2max	0.1	1.1	L2max	0.0689	
10	22	10°	0.055	10	10	0.07	3	L2max	0.035	0.2	L2max	0.12	1.3	L2max	0.0807	
12	26	15°	0.06	12	12	0.08	3.6	L2max	0.04	0.2	L2max	0.14	1.5	L2max	0.0926	
14	30	15°	0.065	14	14	0.085	4.2	L2max	0.04	0.2	L2max	0.15	1.7	L2max	0.098	
16	34	20°	0.07	16	16	0.09	4.8	L2max	0.045	0.2	L2max	0.17	1.9	L2max	0.11	
18	38	20°	0.08	18	18	0.1	5.4	L2max	0.045	0.2	L2max	0.19	2	L2max	0.1194	
20	42	20°	0.09	20	20	0.11	6	L2max	0.05	0.2	L2max	0.21	2.1	L2max	0.1288	
25	52	20°	0.1	25	25	0.12	7.5	L2max	0.055	0.2	L2max	0.23	2.4	L2max	0.1355	

Cooling	
Tolerance	e8
Coating	AlphaNox Navy X

Strategy	ETC	HPC				
Application						
Features	HB	≠	2xD			



Download Catalog Pages (PDF)

	Full Slot	Side Milling	Finishing	ETC	Materialgroup Factor fz / a	Materialgroup Factor ae ETC
--	-----------	--------------	-----------	-----	-----------------------------	-----------------------------

- Optimized microgeometry with higher vibration resistance and increased cutting edge stability
- Special unequal tooth pitch combined with variable helical pitch for smooth running
- Designed for maximum removal rate when milling with high radial depth of cut and in the full slot up to 1xD
- For process reliable ramping, helical immersion and diving (drilling) up to 1xD
- New version with main focus on all CrNi steels (M1.1 / M2.1, V2A)
- Specially designed to withstand the varying additions of CrNi steels

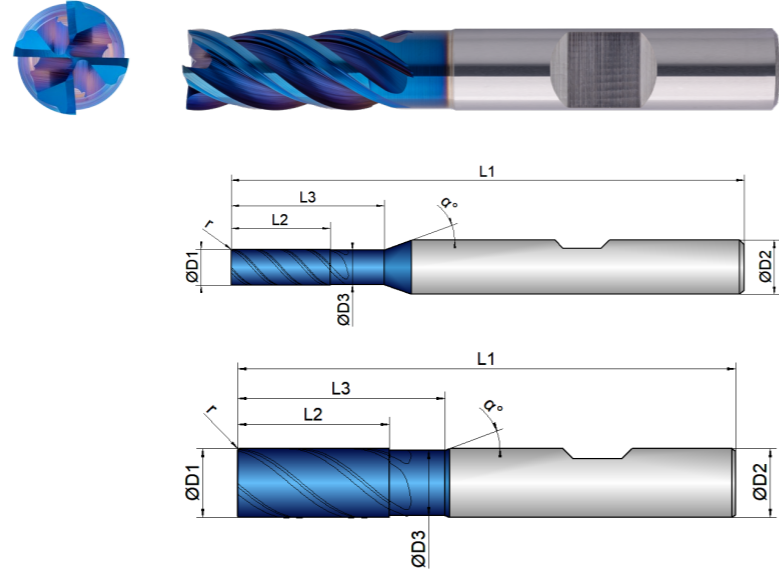

M	Material	Strength (N/mm ²)	Vc = m/min	Vc = m/min	Vc = m/min	Vc = m/min	Materialgroup Factor fz / a	Materialgroup Factor ae ETC
STAINLESS STEEL								
1.1	ferritic/martensitic	<850	110	110	120	176	1	1
2.1	austenitic	<650	100	100	110	161	0.95	0.9
2.2	austenitic	<750	90	90	100	142	0.9	0.8
3.1	DUPLIX STEEL super austenitic	<1100	75	75	85	124	0.85	0.7
STEEL								
1.1-1.5	unalloyed	<1100	180	180	190	240	1	1
2.1-2.4	low alloyed	<1300	145	145	155	180	0.9	0.75
3.1-3.3	high alloyed	<1400	135	135	145	165	0.8	0.7
CASTINGS								
1.1	grey cast iron	<1000	200	200	210	240	0.9	0.8
TITANIUM								
2.1-2.3	pure/alloyed	<1000	50	50	55	100	0.7	0.5

ADVICE | The values marked in turquoise are side applications!
 All fz/a values in the table for material group 1.1, consider factors for the other groups!
 When helical, ramping and drilling use fz 50 % of the full slot.
 The specified values represent starting values for a solid clamping situation.
 To determine the hmax values, please use the provided formula.
 For material groups M2.2 and M3.1, the use of cooling lubricant is recommended!

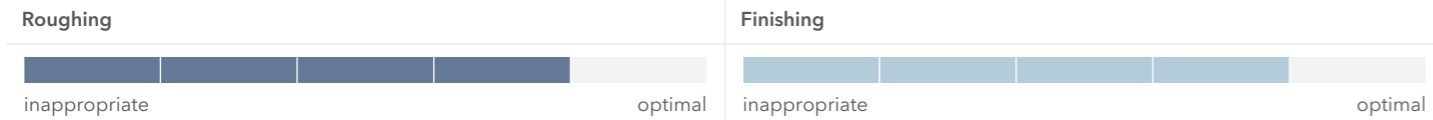

EXM1-M01-0524	D1	D3	L2	L3	L1	D2	z	r	α
	mm	mm	mm	mm	mm	mm	#	mm	°
2	2.0	1.8	5.0	8.0	57.0	6.0	4	0.10	40
3	3.0	2.8	8.0	13.0	57.0	6.0	4	0.10	40
4	4.0	3.7	11.0	17.0	57.0	6.0	4	0.10	40
5	5.0	4.7	13.0	20.0	57.0	6.0	4	0.15	40
6	6.0	5.5	13.0	20.0	57.0	6.0	4	0.15	40
7	7.0	6.5	16.0	25.0	63.0	8.0	4	0.20	40
8	8.0	7.5	19.0	25.0	63.0	8.0	4	0.20	40
10	10.0	9.5	22.0	30.0	72.0	10.0	4	0.20	40
12	12.0	11.0	26.0	36.0	83.0	12.0	4	0.25	40
14	14.0	13.0	30.0	36.0	83.0	14.0	4	0.25	40
16	16.0	15.0	34.0	42.0	92.0	16.0	4	0.30	40
18	18.0	17.0	38.0	42.0	92.0	18.0	4	0.30	40
20	20.0	19.0	42.0	52.0	104.0	20.0	4	0.30	40
25	25.0	24.0	52.0	62.0	125.0	25.0	4	0.30	40

Material M 1.1

D1	L2	Immersion Angle	Full Slot			Side Milling			Finishing			ETC				
			fz	ae = 1xD	ap = 1xD	fz	ae = 0.3xD	ap	fz	ae	ap	fz	ae	ap	hmax	
Ø	mm	α°	(mm/Z)	(mm)	(mm)	(mm/Z)	(mm)	(mm)	(mm/Z)	(mm)	(mm)	(mm/Z)	(mm)	(mm)	(mm)	(mm)
2	5	1.5°	0.017	2	2	0.024	0.6	L2max	0.014	0.2	L2max	0.033	0.25	L2max	0.0218	
3	8	2°	0.02	3	3	0.03	0.9	L2max	0.018	0.2	L2max	0.05	0.4	L2max	0.034	
4	11	3°	0.025	4	4	0.035	1.2	L2max	0.021	0.2	L2max	0.06	0.6	L2max	0.0428	
5	13	4°	0.03	5	5	0.04	1.5	L2max	0.023	0.2	L2max	0.07	0.7	L2max	0.0486	
6	13	5°	0.035	6	6	0.045	1.8	L2max	0.025	0.2	L2max	0.08	0.9	L2max	0.0571	
7	16	6°	0.04	7	7	0.05	2.1	L2max	0.025	0.2	L2max	0.09	1	L2max	0.063	
8	19	8°	0.05	8	8	0.06	2.4	L2max	0.03	0.2	L2max	0.1	1.1	L2max	0.0689	
10	22	10°	0.055	10	10	0.07	3	L2max	0.035	0.2	L2max	0.12	1.3	L2max	0.0807	
12	26	15°	0.06	12	12	0.08	3.6	L2max	0.04	0.2	L2max	0.14	1.5	L2max	0.0926	
14	30	15°	0.065	14	14	0.085	4.2	L2max	0.04	0.2	L2max	0.15	1.7	L2max	0.098	
16	34	20°	0.07	16	16	0.09	4.8	L2max	0.045	0.2	L2max	0.17	1.9	L2max	0.11	
18	38	20°	0.08	18	18	0.1	5.4	L2max	0.045	0.2	L2max	0.19	2	L2max	0.1194	
20	42	20°	0.09	20	20	0.11	6	L2max	0.05	0.2	L2max	0.21	2.1	L2max	0.1288	
25	52	20°	0.1	25	25	0.12	7.5	L2max	0.055	0.2	L2max	0.23	2.4	L2max	0.1355	

Cooling	
Tolerance	e8
Coating	AlphaNox Navy X

Strategy	ETC	HPC		
Application				
Features	HA	≠		2xD



Download Catalog Pages (PDF)

- Extra stable tool core with a slightly conical shape
- Optimized roughing teeth for soft cut and small chips
- Special unequal tooth pitch paired with variable helical pitch



- For roughing, up to 2xD full slot
- For process reliable, helical immersion
- For high radial cutting depths

- Also ideally designed for trochoidal milling

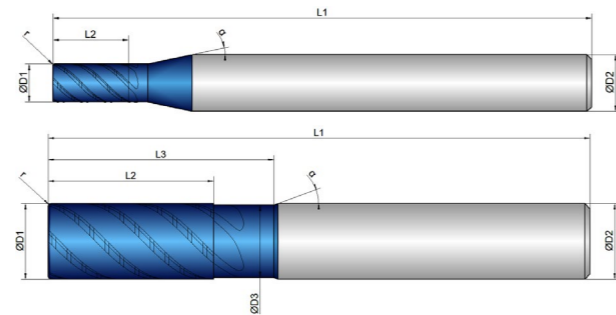

Roughing					Finishing				
inappropriate					optimal				

EXM1-M02-0123	D1	D3	L2	L3	L1	D2	z	r	α
	mm	mm	mm	mm	mm	mm	#	mm	°
4	4.0	0.0	8.0	0.0	57.0	6.0	4	0.10	40
5	5.0	0.0	9.0	0.0	57.0	6.0	4	0.20	40
6	6.0	5.6	13.0	19.0	57.0	6.0	4	0.20	40
8	8.0	7.6	19.0	25.0	63.0	8.0	4	0.20	40
10	10.0	9.6	22.0	30.0	72.0	10.0	4	0.32	40
12	12.0	11.4	26.0	36.0	83.0	12.0	4	0.32	40
16	16.0	15.4	32.0	42.0	92.0	16.0	4	0.32	40
20	20.0	19.4	41.0	52.0	104.0	20.0	4	0.50	40

Material	Strength (N/mm ²)	Full Slot	Side Milling	ETC	Materialgroup Factor fz / a	Materialgroup Factor ae ETC
		Vc = m/min	Vc = m/min	Vc = m/min		
M STAINLESS STEEL						
1.1 ferritic/martensitic	<850	100	100	146	1	1
2.1 austenitic	<650	90	90	133	0.95	0.9
2.2 austenitic	<750	80	80	118	0.9	0.8
3.1 DUPLEX STEEL super austenitic	<1100	70	70	107	0.85	0.7
P STEEL						
1.1-1.5 unalloyed	<1100	180	180	192	1	1
2.1-2.4 low alloyed	<1300	145	145	144	0.9	0.75
3.1-3.3 high alloyed	<1400	135	135	132	0.8	0.7
K CASTINGS						
1.1 grey cast iron	<1000	200	200	192	0.9	0.8
T TITANIUM						
2.1-2.3 pure/alloyed	<1000	50	50	84	0.7	0.5

ADVICE | The values marked in turquoise are side applications!
 All fz/a values in the table for material group 1.1, consider factors for the other groups!
 When helical, ramping and drilling use fz 50 % of the full slot.
 The specified values represent starting values for a solid clamping situation.
 To determine the hmax values, please use the provided formula.
 For material groups M2.2 and M3.1, the use of cooling lubricant is recommended!
 For coarser roughing operations and ETC operations, we recommend a Weldon in conjunction with a Weldon chuck.

Material M 1.1

D1	L2	Immersion Angle	Full Slot			Side Milling			ETC			
			fz	ae = 1xD	ap = 1xD	fz	ae = 0.3xD	ap	fz	ae	ap	hmax
Ø	mm	°	(mm/Z)	(mm)	(mm)	(mm/Z)	(mm)	(mm)	(mm/Z)	(mm)	(mm)	(mm)
4	8	0.5°	0.02	4	4	0.028	1.2	L2max	0.05	0.6	L2max	0.0357
5	9	0.5°	0.025	5	5	0.035	1.5	L2max	0.06	0.7	L2max	0.0416
6	13	0.8°	0.03	6	6	0.04	1.8	L2max	0.07	0.9	L2max	0.05
8	19	1°	0.045	8	8	0.055	2.4	L2max	0.085	1.1	L2max	0.0585
10	22	1.5°	0.05	10	10	0.065	3	L2max	0.1	1.3	L2max	0.0673
12	26	2°	0.055	12	12	0.07	3.6	L2max	0.12	1.5	L2max	0.0794
16	32	2.5°	0.06	16	16	0.08	4.8	L2max	0.15	1.9	L2max	0.097
20	41	3°	0.08	20	20	0.1	6	L2max	0.18	2.1	L2max	0.1104

Cooling	
Tolerance	e8
Coating	AlphaNox Navy X

Strategy	ETC	HPC			 Expert
Application					
Features	HB	≠		2xD	

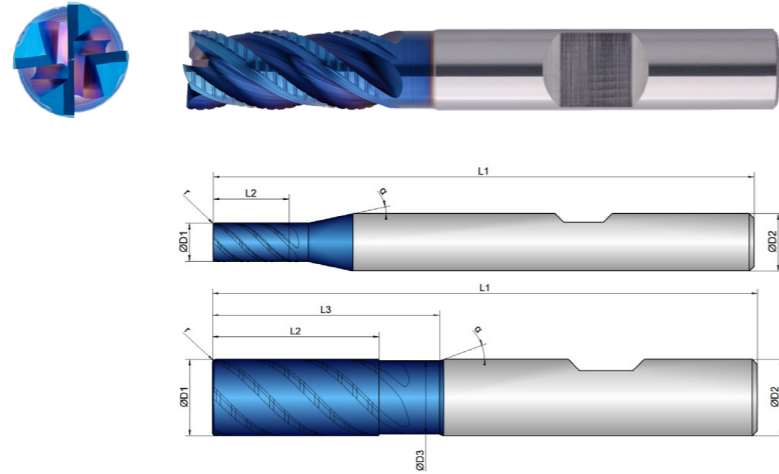

- Extra stable tool core with a slightly conical shape
 - Optimized roughing teeth for soft cut and small chips
 - Special unequal tooth pitch paired with variable helical pitch
- For roughing, up to 2xD full slot
 - For process reliable, helical immersion
 - For high radial cutting depths
- Also ideally designed for trochoidal milling

Roughing					Finishing				
inappropriate					optimal				

EXM1-M02-0124	D1	D3	L2	L3	L1	D2	z	r	α	
	mm	mm	mm	mm	mm	mm	#	mm	°	
4	4.0	0.0	8.0	0.0	57.0	6.0	4	0.10	40	12
5	5.0	0.0	9.0	0.0	57.0	6.0	4	0.20	40	12
6	6.0	5.6	13.0	19.0	57.0	6.0	4	0.20	40	20
8	8.0	7.6	19.0	25.0	63.0	8.0	4	0.20	40	20
10	10.0	9.6	22.0	30.0	72.0	10.0	4	0.32	40	20
12	12.0	11.4	26.0	36.0	83.0	12.0	4	0.32	40	20
16	16.0	15.4	32.0	42.0	92.0	16.0	4	0.32	40	20
20	20.0	19.4	41.0	52.0	104.0	20.0	4	0.50	40	20



Download Catalog Pages (PDF)

Material	Strength (N/mm ²)	Full Slot	Side Milling	ETC	Materialgroup Factor fz / a	Materialgroup Factor ae ETC
		Vc = m/min	Vc = m/min	Vc = m/min		
M STAINLESS STEEL						
1.1 ferritic/martensitic	<850	100	100	146	1	1
2.1 austenitic	<650	90	90	133	0.95	0.9
2.2 austenitic	<750	80	80	118	0.9	0.8
3.1 DUPLEX STEEL super austenitic	<1100	70	70	107	0.85	0.7
P STEEL						
1.1-1.5 unalloyed	<1100	180	180	192	1	1
2.1-2.4 low alloyed	<1300	145	145	144	0.9	0.75
3.1-3.3 high alloyed	<1400	135	135	132	0.8	0.7
K CASTINGS						
1.1 grey cast iron	<1000	200	200	192	0.9	0.8
T TITANIUM						
2.1-2.3 pure/alloyed	<1000	50	50	84	0.7	0.5

ADVICE | The values marked in turquoise are side applications!
 All fz/a values in the table for material group 1.1, consider factors for the other groups!
 When helical, ramping and drilling use fz 50 % of the full slot.
 The specified values represent starting values for a solid clamping situation.
 To determine the hmax values, please use the provided formula.
 For material groups M2.2 and M3.1, the use of cooling lubricant is recommended!

Material M 1.1

D1	L2	Immersion Angle	Full Slot			Side Milling			ETC			
			fz (mm/Z)	ae = 1xD (mm)	ap = 1xD (mm)	fz (mm/Z)	ae = 0.3xD (mm)	ap (mm)	fz (mm/Z)	ae (mm)	ap (mm)	hmax (mm)
4	8	0.5°	0.02	4	4	0.028	1.2	L2max	0.05	0.6	L2max	0.0357
5	9	0.5°	0.025	5	5	0.035	1.5	L2max	0.06	0.7	L2max	0.0416
6	13	0.8°	0.03	6	6	0.04	1.8	L2max	0.07	0.9	L2max	0.05
8	19	1°	0.045	8	8	0.055	2.4	L2max	0.085	1.1	L2max	0.0585
10	22	1.5°	0.05	10	10	0.065	3	L2max	0.1	1.3	L2max	0.0673
12	26	2°	0.055	12	12	0.07	3.6	L2max	0.12	1.5	L2max	0.0794
16	32	2.5°	0.06	16	16	0.08	4.8	L2max	0.15	1.9	L2max	0.097
20	41	3°	0.08	20	20	0.1	6	L2max	0.18	2.1	L2max	0.1104

Cooling	
Tolerance	e8
Coating	AlphaNox Navy X

Strategy	ETC	HPC			 Expert
Application					
Features	HA	≠		3xD	

- Extra stable tool core with a slightly conical shape
 - Optimized roughing teeth for soft cut and small chips
 - Special unequal tooth pitch paired with variable helical pitch
- For roughing, up to 2xD full slot
 - For process reliable, helical immersion
 - For high radial cutting depths
- Also ideally designed for trochoidal milling

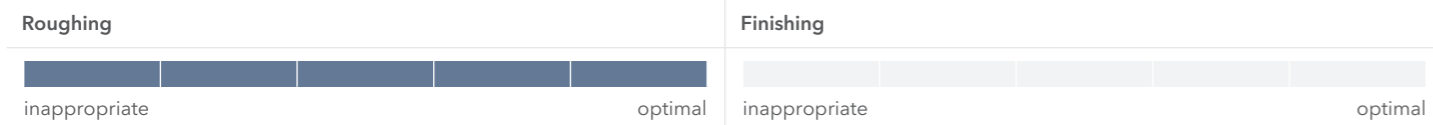
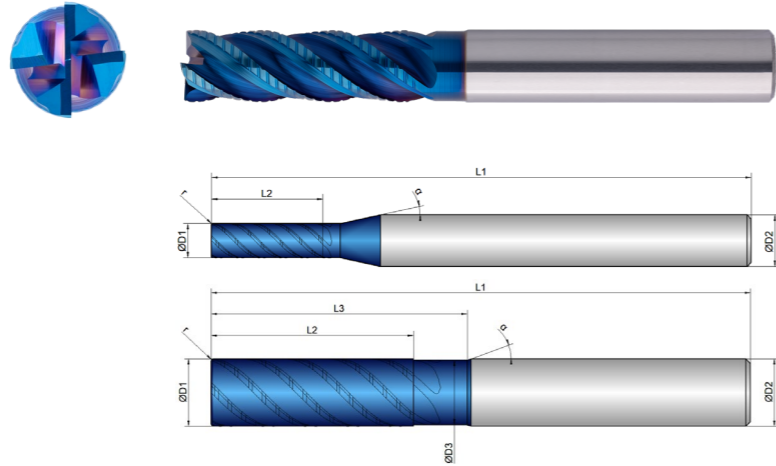

EXM1-M02-0153	D1 mm Ø	D3 mm Ø	L2 mm	L3 mm	L1 mm	D2 mm Ø	z #	r mm		α °
4	4.0	0.0	13.0	0.0	65.0	6.0	4	0.10	40	12
5	5.0	0.0	16.0	0.0	65.0	6.0	4	0.20	40	12
6	6.0	5.6	18.0	24.0	65.0	6.0	4	0.20	40	20
8	8.0	7.6	24.0	30.0	70.0	8.0	4	0.20	40	20
10	10.0	9.6	30.0	38.0	80.0	10.0	4	0.32	40	20
12	12.0	11.4	36.0	46.0	93.0	12.0	4	0.32	40	20
16	16.0	15.4	48.0	58.0	110.0	16.0	4	0.32	40	20
20	20.0	19.4	60.0	74.0	126.0	20.0	4	0.50	40	20



Download Catalog Pages (PDF)

Material	Strength (N/mm ²)	Full Slot	Side Milling	ETC	Materialgroup Factor fz / a	Materialgroup Factor ae ETC
		Vc = m/min	Vc = m/min	Vc = m/min		
M STAINLESS STEEL						
1.1 ferritic/martensitic	<850	95	95	141	1	1
2.1 austenitic	<650	85	85	128	0.95	0.9
2.2 austenitic	<750	75	75	113	0.9	0.8
3.1 DUPLEX STEEL super austenitic	<1100	65	65	102	0.85	0.7
P STEEL						
1.1-1.5 unalloyed	<1100	175	175	187	1	1
2.1-2.4 low alloyed	<1300	140	140	139	0.9	0.75
3.1-3.3 high alloyed	<1400	130	130	137	0.8	0.7
K CASTINGS						
1.1 grey cast iron	<1000	195	195	187	0.9	0.8
T TITANIUM						
2.1-2.3 pure/alloyed	<1000	50	50	84	0.7	0.5

ADVICE | The values marked in turquoise are side applications!
 All fz/a values in the table for material group 1.1, consider factors for the other groups!
 When helical, ramping and drilling use fz 50 % of the full slot.
 The specified values represent starting values for a solid clamping situation.
 To determine the hmax values, please use the provided formula.
 For material groups M2.2 and M3.1, the use of cooling lubricant is recommended!
 For coarser roughing operations and ETC operations, we recommend a Weldon in conjunction with a Weldon chuck.

Material M 1.1

D1 Ø	L2 mm	Immersion Angle °	Full Slot		Side Milling			ETC			
			fz (mm/Z)	ap = 1xD (mm)	fz (mm/Z)	ae = 0.3xD (mm)	ap (mm)	fz (mm/Z)	ae (mm)	ap (mm)	hmax (mm)
4	13	0.5°	0.018	4	0.025	1.2	L2max	0.04	0.6	L2max	0.0286
5	16	0.5°	0.022	5	0.03	1.5	L2max	0.05	0.7	L2max	0.0347
6	18	0.8°	0.025	6	0.035	1.8	L2max	0.06	0.9	L2max	0.0428
8	24	1°	0.035	8	0.05	2.4	L2max	0.075	1.1	L2max	0.0517
10	30	1.2°	0.045	10	0.06	3	L2max	0.09	1.3	L2max	0.0605
12	36	1.5°	0.05	12	0.065	3.6	L2max	0.11	1.5	L2max	0.0728
16	48	2°	0.06	16	0.075	4.8	L2max	0.14	1.9	L2max	0.0906
20	60	2.5°	0.07	20	0.09	6	L2max	0.17	2.1	L2max	0.1042

Cooling	
Tolerance	e8
Coating	AlphaNox Navy X

Strategy	ETC	HPC			 Expert
Application					
Features	HB	≠		3xD	

- Extra stable tool core with a slightly conical shape
 - Optimized roughing teeth for soft cut and small chips
 - Special unequal tooth pitch paired with variable helical pitch
- For roughing, up to 2xD full slot
 - For process reliable, helical immersion
 - For high radial cutting depths
- Also ideally designed for trochoidal milling

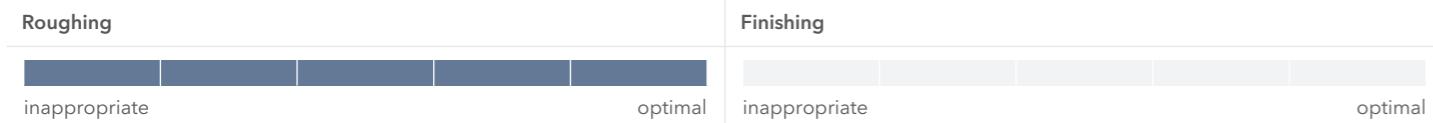
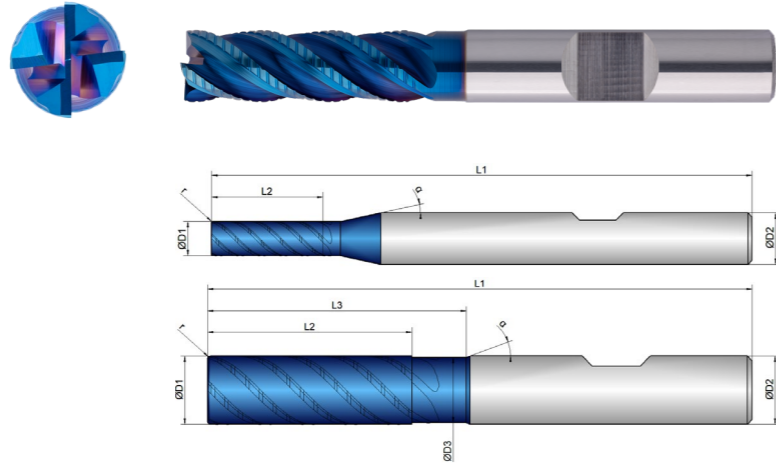

EXM1-M02-0154	D1	D3	L2	L3	L1	D2	z	r		α
	mm \varnothing	mm \varnothing	mm	mm	mm	mm \varnothing	#	mm	°	°
4	4.0	0.0	13.0	0.0	65.0	6.0	4	0.10	40	12
5	5.0	0.0	16.0	0.0	65.0	6.0	4	0.20	40	12
6	6.0	5.6	18.0	24.0	65.0	6.0	4	0.20	40	20
8	8.0	7.6	24.0	30.0	70.0	8.0	4	0.20	40	20
10	10.0	9.6	30.0	38.0	80.0	10.0	4	0.32	40	20
12	12.0	11.4	36.0	46.0	93.0	12.0	4	0.32	40	20
16	16.0	15.4	48.0	58.0	110.0	16.0	4	0.32	40	20
20	20.0	19.4	60.0	74.0	126.0	20.0	4	0.50	40	20



Download Catalog Pages (PDF)

Material	Strength (N/mm ²)	Full Slot	Side Milling	ETC	Materialgroup Factor fz / a	Materialgroup Factor ae ETC
		Vc = m/min	Vc = m/min	Vc = m/min		
M STAINLESS STEEL						
1.1 ferritic/martensitic	<850	95	95	141	1	1
2.1 austenitic	<650	85	85	128	0.95	0.9
2.2 austenitic	<750	75	75	113	0.9	0.8
3.1 DUPLEX STEEL super austenitic	<1100	65	65	102	0.85	0.7
P STEEL						
1.1-1.5 unalloyed	<1100	175	175	187	1	1
2.1-2.4 low alloyed	<1300	140	140	139	0.9	0.75
3.1-3.3 high alloyed	<1400	130	130	137	0.8	0.7
K CASTINGS						
1.1 grey cast iron	<1000	195	195	187	0.9	0.8
T TITANIUM						
2.1-2.3 pure/alloyed	<1000	50	50	84	0.7	0.5

ADVICE | The values marked in turquoise are side applications!
 All fz/a values in the table for material group 1.1, consider factors for the other groups!
 When helical, ramping and drilling use fz 50 % of the full slot.
 The specified values represent starting values for a solid clamping situation.
 To determine the hmax values, please use the provided formula.
 For material groups M2.2 and M3.1, the use of cooling lubricant is recommended!

Material M 1.1

D1	L2	Immersion Angle	Full Slot			Side Milling			ETC			
			fz (mm/Z)	ae = 1xD (mm)	ap = 1xD (mm)	fz (mm/Z)	ae = 0.3xD (mm)	ap (mm)	fz (mm/Z)	ae (mm)	ap (mm)	hmax (mm)
4	13	0.5°	0.018	4	4	0.025	1.2	L2max	0.04	0.6	L2max	0.0286
5	16	0.5°	0.022	5	5	0.03	1.5	L2max	0.05	0.7	L2max	0.0347
6	18	0.8°	0.025	6	6	0.035	1.8	L2max	0.06	0.9	L2max	0.0428
8	24	1°	0.035	8	8	0.05	2.4	L2max	0.075	1.1	L2max	0.0517
10	30	1.2°	0.045	10	10	0.06	3	L2max	0.09	1.3	L2max	0.0605
12	36	1.5°	0.05	12	12	0.065	3.6	L2max	0.11	1.5	L2max	0.0728
16	48	2°	0.06	16	16	0.075	4.8	L2max	0.14	1.9	L2max	0.0906
20	60	2.5°	0.07	20	20	0.09	6	L2max	0.17	2.1	L2max	0.1042

Cooling	
Tolerance	e8
Coating	AlphaNox Navy X

Strategy	ETC	HPC	
Application			
Features	HA	≠	4xD



Download Catalog Pages (PDF)

Side Milling	ETC	Materialgroup Factor fz / a	Materialgroup Factor ae ETC
--------------	-----	-----------------------------	-----------------------------

- Extra stable tool core with a slightly conical shape
- Optimized roughing teeth for soft cut and small chips
- Special unequal tooth pitch paired with variable helical pitch



- For process reliable, helical immersion
- For high radial cutting depths

- Excellent for trochoidal milling

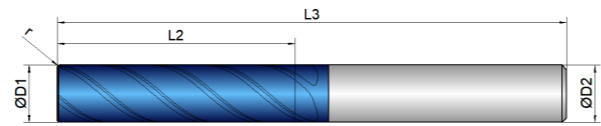

Roughing	Finishing
inappropriate	optimal

EXM1-M02-0323	D1 mm Ø	L2 mm	L1 mm	D2 mm Ø	z #	r mm	
6	6.0	25.0	65.0	6.0	4	0.20	40
8	8.0	34.0	75.0	8.0	4	0.25	40
10	10.0	42.0	90.0	10.0	4	0.25	40
12	12.0	50.0	100.0	12.0	4	0.30	40
16	16.0	66.0	130.0	16.0	4	0.40	40
20	20.0	82.0	150.0	20.0	4	0.50	40

Material	Strength (N/mm ²)	Vc = m/min	Vc = m/min	Materialgroup Factor fz / a	Materialgroup Factor ae ETC
M STAINLESS STEEL					
1.1 ferritic/martensitic	<850	95	141	1	1
2.1 austenitic	<650	85	128	0.95	0.9
2.2 austenitic	<750	75	113	0.9	0.8
3.1 DUPLEX STEEL super austenitic	<1100	65	102	0.85	0.7
P STEEL					
1.1-1.5 unalloyed	<1100	175	187	1	1
2.1-2.4 low alloyed	<1300	140	139	0.9	0.75
3.1-3.3 high alloyed	<1400	130	137	0.8	0.7
K CASTINGS					
1.1 grey cast iron	<1000	195	187	0.9	0.8
T TITANIUM					
2.1-2.3 pure/alloyed	<1000	50	84	0.7	0.5

ADVICE | The values marked in turquoise are side applications!
 All fz/a values in the table for material group 1.1, consider factors for the other groups!
 When helical and ramping, use fz 50 % of side milling.
 The specified values represent starting values for a solid clamping situation.
 To determine the hmax values, please use the provided formula.
 For material groups M2.2 and M3.1, the use of cooling lubricant is recommended!
 For coarser roughing operations and ETC operations, we recommend a Weldon in conjunction with a Weldon chuck.

Material M 1.1

D1 Ø	L2 mm	Immersion Angle α°	Side Milling			ETC			
			fz (mm/Z)	ae = 0.1xD (mm)	ap (mm)	fz (mm/Z)	ae (mm)	ap (mm)	hmax (mm)
6	25	0.6°	0.025	0.6	L2max	0.05	0.4	L2max	0.0249
8	34	0.8°	0.035	0.8	L2max	0.064	0.52	L2max	0.0316
10	42	1°	0.05	1	L2max	0.078	0.65	L2max	0.0385
12	50	1.2°	0.055	1.2	L2max	0.094	0.8	L2max	0.0469
16	66	1.6°	0.065	1.6	L2max	0.11	1.05	L2max	0.0545
20	82	2°	0.075	2	L2max	0.135	1.3	L2max	0.0665

Cooling	
Tolerance	e8
Coating	AlphaNox Navy X

Strategy	ETC	HPC	
Application			
Features	HB	≠	4xD

- Extra stable tool core with a slightly conical shape
 - Optimized roughing teeth for soft cut and small chips
 - Special unequal tooth pitch paired with variable helical pitch
- For process reliable, helical immersion
 - For high radial cutting depths
- Excellent for trochoidal milling

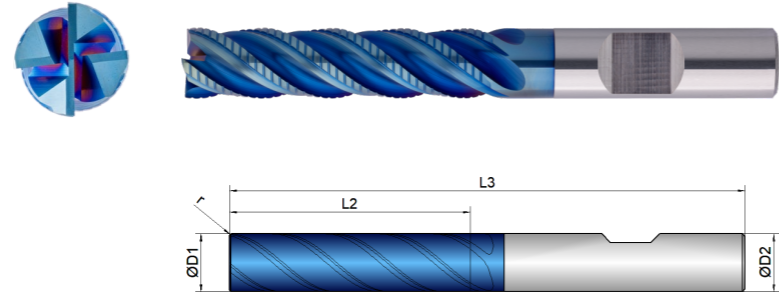

Roughing				Finishing			
inappropriate				inappropriate			
optimal				optimal			

EXM1-M02-0324	D1 mm \varnothing	L2 mm	L1 mm	D2 mm \varnothing	z #	r mm	
6	6.0	25.0	65.0	6.0	4	0.20	40
8	8.0	34.0	75.0	8.0	4	0.25	40
10	10.0	42.0	90.0	10.0	4	0.25	40
12	12.0	50.0	100.0	12.0	4	0.30	40
16	16.0	66.0	130.0	16.0	4	0.40	40
20	20.0	82.0	150.0	20.0	4	0.50	40



Download Catalog Pages (PDF)

Material	Strength (N/mm ²)	Side Milling	ETC	Materialgroup Factor fz / a	Materialgroup Factor ae ETC
		Vc = m/min	Vc = m/min		
M STAINLESS STEEL					
1.1 ferritic/martensitic	<850	95	141	1	1
2.1 austenitic	<650	85	128	0.95	0.9
2.2 austenitic	<750	75	113	0.9	0.8
3.1 DUPLEX STEEL super austenitic	<1100	65	102	0.85	0.7
P STEEL					
1.1-1.5 unalloyed	<1100	175	187	1	1
2.1-2.4 low alloyed	<1300	140	139	0.9	0.75
3.1-3.3 high alloyed	<1400	130	137	0.8	0.7
K CASTINGS					
1.1 grey cast iron	<1000	195	187	0.9	0.8
T TITANIUM					
2.1-2.3 pure/alloyed	<1000	50	84	0.7	0.5

ADVICE | The values marked in turquoise are side applications!
 All fz/a values in the table for material group 1.1, consider factors for the other groups!
 When helical and ramping, use fz 50 % of side milling.
 The specified values represent starting values for a solid clamping situation.
 To determine the hmax values, please use the provided formula.
 For material groups M2.2 and M3.1, the use of cooling lubricant is recommended!

Material M 1.1

D1 mm \varnothing	L2 mm	Immersion Angle α°	Side Milling			ETC			
			fz (mm/Z)	ae = 0.1xD (mm)	ap (mm)	fz (mm/Z)	ae (mm)	ap (mm)	hmax (mm)
6	25	0.6°	0.025	0.6	L2max	0.05	0.4	L2max	0.0249
8	34	0.8°	0.035	0.8	L2max	0.064	0.52	L2max	0.0316
10	42	1°	0.05	1	L2max	0.078	0.65	L2max	0.0385
12	50	1.2°	0.055	1.2	L2max	0.094	0.8	L2max	0.0469
16	66	1.6°	0.065	1.6	L2max	0.11	1.05	L2max	0.0545
20	82	2°	0.075	2	L2max	0.135	1.3	L2max	0.0665

Cooling	
Tolerance	e8
Coating	AlphaNox Navy X

Strategy	HPC	
Application		
Features	HA ≠ 2xD	

- Extra stable tool core with a slightly conical shape
- Optimized roughing teeth for soft cut and small chips
- Special unequal tooth pitch paired with variable helical pitch



- Overlong version for deepest cavities

- For process reliable, helical immersion
- For high radial cutting depths

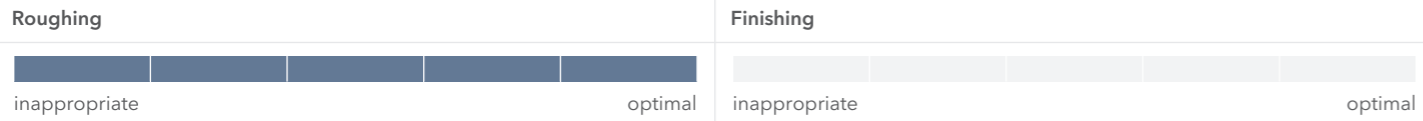
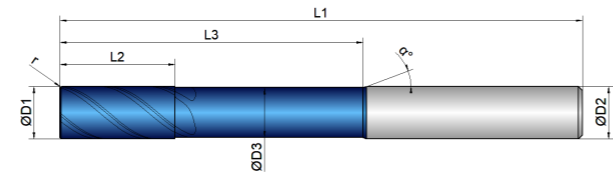

EXM1-M02-0623	D1 mm ø	D3 mm ø	L2 mm	L3 mm	L1 mm	D2 mm ø	z #	r mm	α °	α_0 °
6	6.0	5.5	13.0	42.0	83.0	6.0	4	0.20	40	20
8	8.0	7.5	19.0	52.0	100.0	8.0	4	0.25	40	20
10	10.0	9.5	22.0	58.0	100.0	10.0	4	0.25	40	20
12	12.0	11.0	26.0	72.0	120.0	12.0	4	0.30	40	20
16	16.0	15.0	34.0	94.0	150.0	16.0	4	0.40	40	20
20	20.0	19.0	42.0	98.0	150.0	20.0	4	0.50	40	20



Download Catalog Pages (PDF)

Material	Strength (N/mm ²)	Side Milling	Materialgroup	Factor fz
----------	-------------------------------	--------------	---------------	-----------

M	STAINLESS STEEL		Vc = m/min	
1.1	ferritic/martensitic	<850	85	1
2.1	austenitic	<650	75	0.95
2.2	austenitic	<750	65	0.9
3.1	DUPLEX STEEL super austenitic	<1100	55	0.85
P	STEEL		Vc = m/min	
1.1-1.5	unalloyed	<1100	95	1
2.1-2.4	low alloyed	<1300	80	0.9
3.1-3.3	high alloyed	<1400	70	0.8
K	CASTINGS		Vc = m/min	
1.1	grey cast iron	<1000	110	0.9
T	TITANIUM		Vc = m/min	
2.1-2.3	pure/alloyed	<1000	35	0.7

ADVICE | The values marked in turquoise are side applications!
 All fz/a values in the table for material group 1.1, consider factors for the other groups!
 When helical, reduce fz by 50%.
 The specified values represent starting values for a solid clamping situation.
 For material groups M2.2 and M3.1, the use of cooling lubricant is recommended!

Material M 1.1

D1 ø	L2 mm	Immersion Angle α °	Side Milling		
			fz (mm/Z)	ae = 0.1xD (mm)	ap (mm)
6	13	0.3°	0.03	0.6	L2max
8	19	0.4°	0.04	0.8	L2max
10	22	0.6°	0.05	1	L2max
12	26	0.8°	0.06	1.2	L2max
16	34	1°	0.07	1.6	L2max
20	42	1.2°	0.085	2	L2max

Cooling	
Tolerance	e8
Coating	AlphaNox Navy X

Strategy	HPC	
Application		
Features	HB, ≠, 2xD,	

- Extra stable tool core with a slightly conical shape
 - Optimized roughing teeth for soft cut and small chips
 - Special unequal tooth pitch paired with variable helical pitch
-
- Overlong version for deepest cavities
-
- For process reliable, helical immersion
 - For high radial cutting depths

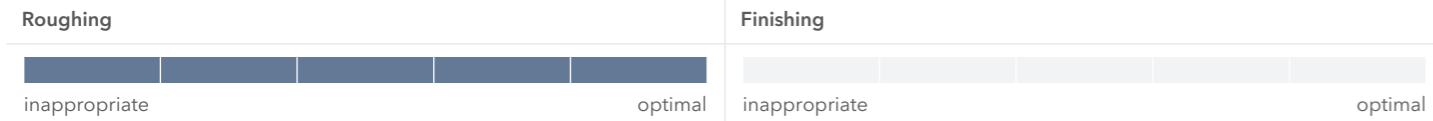
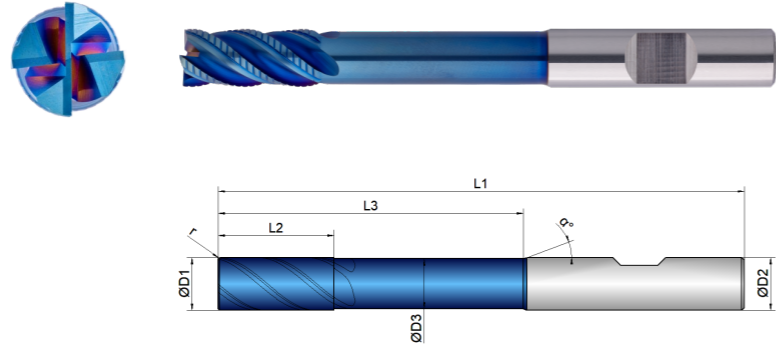

EXM1-M02-0624	D1 mm ∅	D3 mm ∅	L2 mm	L3 mm	L1 mm	D2 mm ∅	z #	r mm		α °
6	6.0	5.5	13.0	42.0	83.0	6.0	4	0.20	40	20
8	8.0	7.5	19.0	52.0	100.0	8.0	4	0.25	40	20
10	10.0	9.5	22.0	58.0	100.0	10.0	4	0.25	40	20
12	12.0	11.0	26.0	72.0	120.0	12.0	4	0.30	40	20
16	16.0	15.0	34.0	94.0	150.0	16.0	4	0.40	40	20
20	20.0	19.0	42.0	98.0	150.0	20.0	4	0.50	40	20



Download Catalog Pages (PDF)

Material	Strength (N/mm ²)	Vc = m/min	Materialgroup	Factor fz
M STAINLESS STEEL				
1.1	ferritic/martensitic <850	85	1	1
2.1	austenitic <650	75	0.95	0.95
2.2	austenitic <750	65	0.9	0.9
3.1	DUPLEX STEEL super austenitic <1100	55	0.85	0.85
P STEEL				
1.1-1.5	unalloyed <1100	95	1	1
2.1-2.4	low alloyed <1300	80	0.9	0.9
3.1-3.3	high alloyed <1400	70	0.8	0.8
K CASTINGS				
1.1	grey cast iron <1000	110	0.9	0.9
T TITANIUM				
2.1-2.3	pure/alloyed <1000	35	0.7	0.7

ADVICE | The values marked in turquoise are side applications!
 All fz/a values in the table for material group 1.1, consider factors for the other groups!
 When helical, reduce fz by 50%.
 The specified values represent starting values for a solid clamping situation.
 For material groups M2.2 and M3.1, the use of cooling lubricant is recommended!

Material M 1.1

D1 ∅	L2 mm	Immersion Angle α°	Side Milling		
			fz (mm/Z)	ae = 0.1xD (mm)	ap (mm)
6	13	0.3°	0.03	0.6	L2max
8	19	0.4°	0.04	0.8	L2max
10	22	0.6°	0.05	1	L2max
12	26	0.8°	0.06	1.2	L2max
16	34	1°	0.07	1.6	L2max
20	42	1.2°	0.085	2	L2max

Cooling	
Tolerance	e8
Coating	AlphaNox Navy X

Strategy	ETC		
Application			
Features	HA	≠	2xD

- 6 cutting edges for best performance and an excellent material removal rate
- Optimized cutting edges and chip chambers to effectively prevent built-up edges and chip stuck
- For roughing and finishing under ETC conditions
- For process reliable, helical immersion
- Ideal chip evacuation, even with high feed rates and big radial depth of cutting

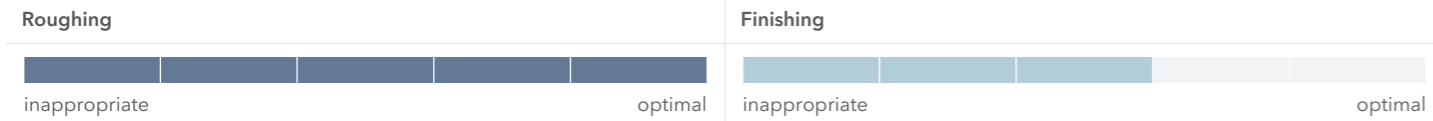
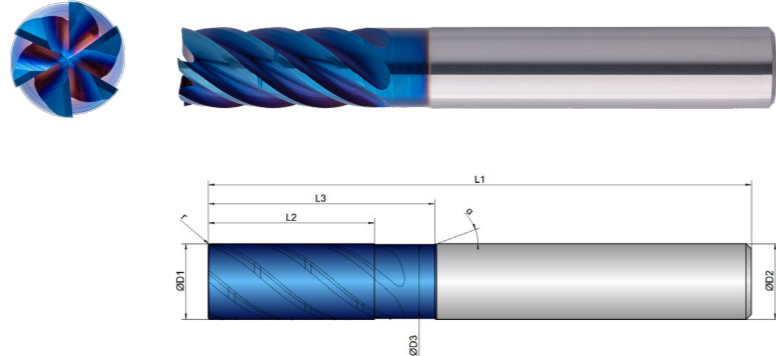

EXM1-M03-0103	D1 mm ∅	D3 mm ∅	L2 mm	L3 mm	L1 mm	D2 mm ∅	z #	r mm	α °
6	6.0	5.8	15.0	19.0	57.0	6.0	6	0.15	40
6/0,5	6.0	5.8	15.0	19.0	57.0	6.0	6	0.50	40
6/1	6.0	5.8	15.0	19.0	57.0	6.0	6	1.00	40
6/2	6.0	5.8	15.0	19.0	57.0	6.0	6	2.00	40
8	8.0	7.8	21.0	25.0	63.0	8.0	6	0.20	40
8/0,5	8.0	7.8	21.0	25.0	63.0	8.0	6	0.50	40
8/1	8.0	7.8	21.0	25.0	63.0	8.0	6	1.00	40
8/2	8.0	7.8	21.0	25.0	63.0	8.0	6	2.00	40
10	10.0	9.8	24.0	30.0	72.0	10.0	6	0.20	40
10/0,5	10.0	9.8	24.0	30.0	72.0	10.0	6	0.50	40
10/1	10.0	9.8	24.0	30.0	72.0	10.0	6	1.00	40

EXM1-M03-0103	D1 mm ∅	D3 mm ∅	L2 mm	L3 mm	L1 mm	D2 mm ∅	z #	r mm	α °
10/2	10.0	9.8	24.0	30.0	72.0	10.0	6	2.00	40
12	12.0	11.8	29.0	36.0	83.0	12.0	6	0.20	40
12/0,5	12.0	11.8	29.0	36.0	83.0	12.0	6	0.50	40
12/1	12.0	11.8	29.0	36.0	83.0	12.0	6	1.00	40
12/2	12.0	11.8	29.0	36.0	83.0	12.0	6	2.00	40
16	16.0	15.8	35.0	42.0	92.0	16.0	6	0.30	40
16/0,5	16.0	15.8	35.0	42.0	92.0	16.0	6	0.50	40
16/1	16.0	15.8	35.0	42.0	92.0	16.0	6	1.00	40
16/2	16.0	15.8	35.0	42.0	92.0	16.0	6	2.00	40
20	20.0	19.8	44.0	52.0	104.0	20.0	6	0.30	40
20/0,5	20.0	19.8	44.0	52.0	104.0	20.0	6	0.50	40
20/1	20.0	19.8	44.0	52.0	104.0	20.0	6	1.00	40
20/2	20.0	19.8	44.0	52.0	104.0	20.0	6	2.00	40









Download Catalog Pages (PDF)

Material	Strength (N/mm ²)	ETC	Finishing	Materialgroup Factor fz	Materialgroup Factor ae ETC
		Vc = m/min	Vc = m/min		
M STAINLESS STEEL					
1.1 ferritic/martensitic	<850	176	90	1	1
2.1 austenitic	<650	161	80	0.95	0.9
2.2 austenitic	<750	142	75	0.9	0.8
3.1 DUPLEX STEEL super austenitic	<1100	124	65	0.85	0.7
P STEEL					
1.1-1.5 unalloyed	<1100	240	230	1	1
2.1-2.4 low alloyed	<1300	180	200	0.9	0.75
3.1-3.3 high alloyed	<1400	165	180	0.8	0.7
K CASTINGS					
1.1 grey cast iron	<1000	240	215	0.9	0.8
T TITANIUM					
2.1-2.3 pure/alloyed	<1000	100	60	0.7	0.5

ADVICE | The values marked in turquoise are side applications!
 All fz/a values in the table for material group 1.1, consider factors for the other groups!
 When helical, reduce fz by 50 %.
 The specified values represent starting values for a solid clamping situation.
 To determine the hmax values, please use the provided formula.
 For material groups M2.2 and M3.1, the use of cooling lubricant is recommended!
 For coarser roughing operations and ETC operations, we recommend a Weldon in conjunction with a Weldon chuck.

Material M 1.1

D1 	L2 	Immersion Angle 	ETC high dynamic 				ETC low dynamic 				Finishing 	
			fz (mm/Z)	ae = 0.1xD (mm)	ap (mm)	hmax (mm)	fz (mm/Z)	ae = 0.15xD (mm)	ap (mm)	hmax (mm)	fz (mm/Z)	ae (mm)
6	15	0.6°	0.08	0.6	L2max	0.048	0.066	0.9	L2max	0.471	0.025	0.2
8	21	0.8°	0.1	0.8	L2max	0.06	0.082	1.2	L2max	0.0586	0.03	0.2
10	24	0.8°	0.12	1	L2max	0.072	0.098	1.5	L2max	0.07	0.032	0.2
12	29	1°	0.14	1.2	L2max	0.084	0.115	1.8	L2max	0.0821	0.034	0.2
16	35	1.2°	0.16	1.6	L2max	0.096	0.131	2.4	L2max	0.0936	0.036	0.2
20	44	1.5°	0.18	2	L2max	0.108	0.148	3	L2max	0.1057	0.038	0.2



STILL CAN'T FIND A SUITABLE MILLING CUTTER?

No problem - simply customize an existing tool. Using our configurator for special milling cutters, you can customize existing tools to your needs in an instant or create your own tools based on predefined types.

WE WILL RESPOND TO ALL REQUESTS SUBMITTED VIA THE CONFIGURATOR WITHIN ONE WORKING DAY AT THE LATEST



Cooling	
Tolerance	e8
Coating	AlphaNox Navy X

Strategy	ETC			 Expert
Application				
Features	HB 	≠ 	2xD 	

- 6 cutting edges for best performance and an excellent material removal rate
- Optimized cutting edges and chip chambers to effectively prevent built-up edges and chip stuck
- For roughing and finishing under ETC conditions
- For process reliable, helical immersion
- Ideal chip evacuation, even with high feed rates and big radial depth of cutting

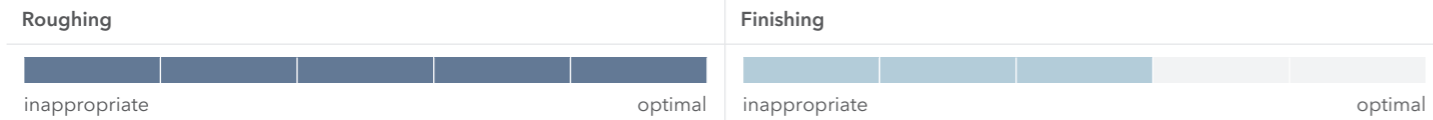
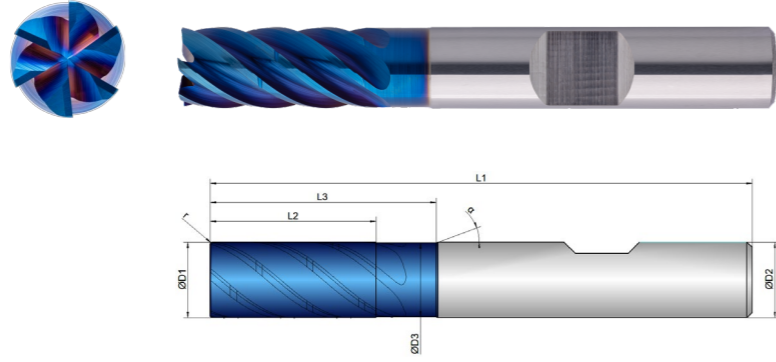

EXM1-M03-0104	D1 mm 	D3 mm 	L2 mm 	L3 mm 	L1 mm 	D2 mm 	z # 	r mm 		α °
6	6.0	5.8	15.0	19.0	57.0	6.0	6	0.15	40	20
6/0,5	6.0	5.8	15.0	19.0	57.0	6.0	6	0.50	40	20
6/1	6.0	5.8	15.0	19.0	57.0	6.0	6	1.00	40	20
6/2	6.0	5.8	15.0	19.0	57.0	6.0	6	2.00	40	20
8	8.0	7.8	21.0	25.0	63.0	8.0	6	0.20	40	20
8/0,5	8.0	7.8	21.0	25.0	63.0	8.0	6	0.50	40	20
8/1	8.0	7.8	21.0	25.0	63.0	8.0	6	1.00	40	20
8/2	8.0	7.8	21.0	25.0	63.0	8.0	6	2.00	40	20
10	10.0	9.8	24.0	30.0	72.0	10.0	6	0.20	40	20
10/0,5	10.0	9.8	24.0	30.0	72.0	10.0	6	0.50	40	20

EXM1-M03-0104	D1 mm 	D3 mm 	L2 mm 	L3 mm 	L1 mm 	D2 mm 	z # 	r mm 		α °
10/1	10.0	9.8	24.0	30.0	72.0	10.0	6	1.00	40	20
10/2	10.0	9.8	24.0	30.0	72.0	10.0	6	2.00	40	20
12	12.0	11.8	29.0	36.0	83.0	12.0	6	0.20	40	20
12/0,5	12.0	11.8	29.0	36.0	83.0	12.0	6	0.50	40	20
12/1	12.0	11.8	29.0	36.0	83.0	12.0	6	1.00	40	20
12/2	12.0	11.8	29.0	36.0	83.0	12.0	6	2.00	40	20
16	16.0	15.8	35.0	42.0	92.0	16.0	6	0.30	40	20
16/0,5	16.0	15.8	35.0	42.0	92.0	16.0	6	0.50	40	20
16/1	16.0	15.8	35.0	42.0	92.0	16.0	6	1.00	40	20
16/2	16.0	15.8	35.0	42.0	92.0	16.0	6	2.00	40	20
20	20.0	19.8	44.0	52.0	104.0	20.0	6	0.30	40	20
20/0,5	20.0	19.8	44.0	52.0	104.0	20.0	6	0.50	40	20
20/1	20.0	19.8	44.0	52.0	104.0	20.0	6	1.00	40	20
20/2	20.0	19.8	44.0	52.0	104.0	20.0	6	2.00	40	20



Download Catalog Pages (PDF)

Material	Strength (N/mm ²)	ETC	Finishing	Materialgroup Factor fz	Materialgroup Factor ae ETC
		Vc = m/min	Vc = m/min		
M STAINLESS STEEL					
1.1 ferritic/martensitic	<850	176	90	1	1
2.1 austenitic	<650	161	80	0.95	0.9
2.2 austenitic	<750	142	75	0.9	0.8
3.1 DUPLEX STEEL super austenitic	<1100	124	65	0.85	0.7
P STEEL					
1.1-1.5 unalloyed	<1100	240	230	1	1
2.1-2.4 low alloyed	<1300	180	200	0.9	0.75
3.1-3.3 high alloyed	<1400	165	180	0.8	0.7
K CASTINGS					
1.1 grey cast iron	<1000	240	215	0.9	0.8
T TITANIUM					
2.1-2.3 pure/alloyed	<1000	100	60	0.7	0.5

ADVICE | The values marked in turquoise are side applications!
 All fz/a values in the table for material group 1.1, consider factors for the other groups!
 When helical, reduce fz by 50 %.
 The specified values represent starting values for a solid clamping situation.
 To determine the hmax values, please use the provided formula.
 For material groups M2.2 and M3.1, the use of cooling lubricant is recommended!

Material M 1.1

D1	L2	Immersion Angle	ETC high dynamic				ETC low dynamic				Finishing	
			fz (mm/Z)	ae = 0.1xD (mm)	ap (mm)	hmax (mm)	fz (mm/Z)	ae = 0.15xD (mm)	ap (mm)	hmax (mm)	fz (mm/Z)	ae (mm)
6	15	0.6°	0.08	0.6	L2max	0.048	0.066	0.9	L2max	0.471	0.025	0.2
8	21	0.8°	0.1	0.8	L2max	0.06	0.082	1.2	L2max	0.0586	0.03	0.2
10	24	0.8°	0.12	1	L2max	0.072	0.098	1.5	L2max	0.07	0.032	0.2
12	29	1°	0.14	1.2	L2max	0.084	0.115	1.8	L2max	0.0821	0.034	0.2
16	35	1.2°	0.16	1.6	L2max	0.096	0.131	2.4	L2max	0.0936	0.036	0.2
20	44	1.5°	0.18	2	L2max	0.108	0.148	3	L2max	0.1057	0.038	0.2

DO YOU HAVE BLUNT MILLING CUTTERS THAT URGENTLY NEED REGRINDING?



DISCOVER OUR H&V REGRINDING SERVICE

... and have your tools reconditioned to their original state!



Cooling	
Tolerance	e8
Coating	AlphaNox Navy X

Strategy	ETC	
Application		
Features	HA, ≠, 3xD,	

- 6 cutting edges for best performance and an excellent material removal rate
- Optimized cutting edges and chip chambers to effectively prevent built-up edges and chip stuck
- For roughing and finishing under ETC conditions
- For process reliable, helical immersion
- Ideal chip evacuation, even with high feed rates and big radial depth of cutting

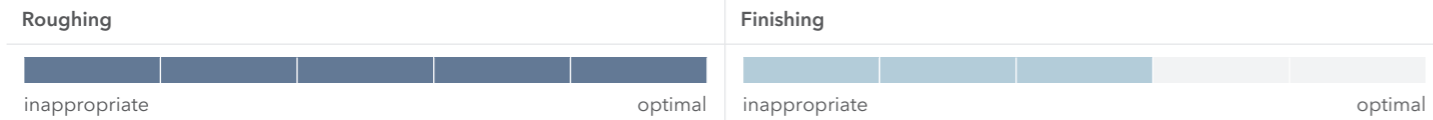
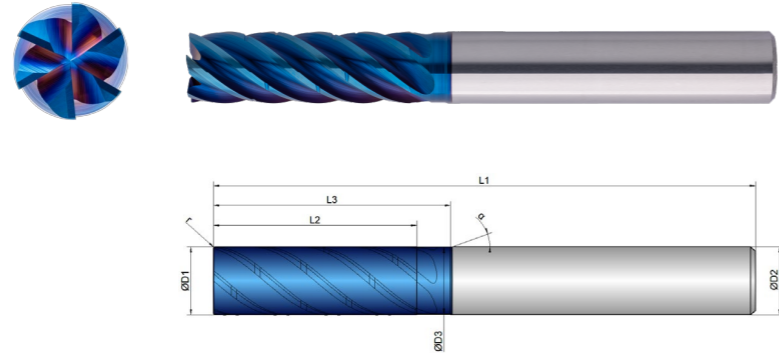

EXM1-M03-0113	D1 mm 	D3 mm 	L2 mm 	L3 mm 	L1 mm 	D2 mm 	z # 	r mm 		α °
6	6.0	5.8	20.0	25.0	63.0	6.0	6	0.15	40	20
8	8.0	7.8	26.0	30.0	70.0	8.0	6	0.20	40	20
10	10.0	9.8	32.0	36.0	80.0	10.0	6	0.20	40	20
12	12.0	11.8	39.0	45.0	93.0	12.0	6	0.20	40	20
16	16.0	15.8	51.0	55.0	110.0	16.0	6	0.30	40	20
20	20.0	19.8	63.0	70.0	125.0	20.0	6	0.30	40	20



Download Catalog Pages (PDF)

Material	Strength (N/mm ²)	ETC Vc = m/min	Finishing Vc = m/min	Materialgroup Factor fz	Materialgroup Factor ae ETC
M STAINLESS STEEL					
1.1 ferritic/martensitic	<850	176	90	1	1
2.1 austenitic	<650	161	80	0.95	0.9
2.2 austenitic	<750	142	75	0.9	0.8
3.1 DUPLEX STEEL super austenitic	<1100	124	65	0.85	0.7
P STEEL					
1.1-1.5 unalloyed	<1100	240	230	1	1
2.1-2.4 low alloyed	<1300	180	200	0.9	0.75
3.1-3.3 high alloyed	<1400	165	180	0.8	0.7
K CASTINGS					
1.1 grey cast iron	<1000	240	215	0.9	0.8
T TITANIUM					
2.1-2.3 pure/alloyed	<1000	100	60	0.7	0.5

ADVICE | The values marked in turquoise are side applications!
 All fz/a values in the table for material group 1.1, consider factors for the other groups!
 When helical, reduce fz by 50 %.
 The specified values represent starting values for a solid clamping situation.
 To determine the hmax values, please use the provided formula.
 For material groups M2.2 and M3.1, the use of cooling lubricant is recommended!
 For coarser roughing operations and ETC operations, we recommend a Weldon in conjunction with a Weldon chuck.

Material M 1.1

D1 mm 	L2 mm 	Immersion Angle α° 	ETC high dynamic 				ETC low dynamic 				Finishing 	
			fz (mm/Z)	ae = 0.07xD (mm)	ap (mm)	hmax (mm)	fz (mm/Z)	ae = 0.12xD (mm)	ap (mm)	hmax (mm)	fz (mm/Z)	ae (mm)
6	20	0.6°	0.07	0.42	L2max	0.0357	0.057	0.72	L2max	0.037	0.025	0.2
8	26	0.8°	0.09	0.56	L2max	0.0459	0.074	0.96	L2max	0.0481	0.03	0.2
10	32	0.8°	0.11	0.7	L2max	0.0561	0.090	1.2	L2max	0.0585	0.032	0.2
12	39	1°	0.13	0.84	L2max	0.0663	0.107	1.44	L2max	0.0695	0.034	0.2
16	51	1.2°	0.15	1.12	L2max	0.0765	0.123	1.92	L2max	0.0799	0.036	0.2
20	63	1.5°	0.17	1.4	L2max	0.0867	0.139	2.4	L2max	0.0903	0.038	0.2

Cooling	
Tolerance	e8
Coating	AlphaNox Navy X

Strategy	ETC	
Application		
Features	HB, ≠, 3xD,	

- 6 cutting edges for best performance and an excellent material removal rate
- Optimized cutting edges and chip chambers to effectively prevent built-up edges and chip stuck
- For roughing and finishing under ETC conditions
- For process reliable, helical immersion
- Ideal chip evacuation, even with high feed rates and big radial depth of cutting

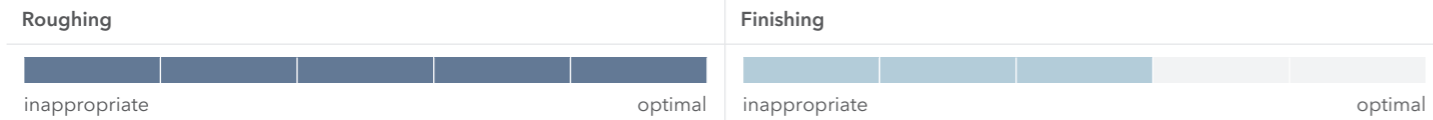
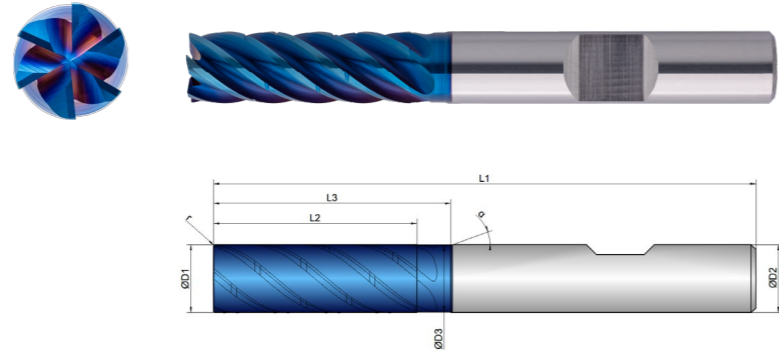

EXM1-M03-0114	D1 mm 	D3 mm 	L2 mm 	L3 mm 	L1 mm 	D2 mm 	z # 	r mm 		α °
6	6.0	5.8	20.0	25.0	63.0	6.0	6	0.15	40	20
8	8.0	7.8	26.0	30.0	70.0	8.0	6	0.20	40	20
10	10.0	9.8	32.0	36.0	80.0	10.0	6	0.20	40	20
12	12.0	11.8	39.0	45.0	93.0	12.0	6	0.20	40	20
16	16.0	15.8	51.0	55.0	110.0	16.0	6	0.30	40	20
20	20.0	19.8	63.0	70.0	125.0	20.0	6	0.30	40	20



Download Catalog Pages (PDF)









Material	Strength (N/mm ²)	ETC Vc = m/min	Finishing Vc = m/min	Materialgroup Factor fz	Materialgroup Factor ae ETC
M STAINLESS STEEL					
1.1 ferritic/martensitic	<850	176	90	1	1
2.1 austenitic	<650	161	80	0.95	0.9
2.2 austenitic	<750	142	75	0.9	0.8
3.1 DUPLEX STEEL super austenitic	<1100	124	65	0.85	0.7
P STEEL					
1.1-1.5 unalloyed	<1100	240	230	1	1
2.1-2.4 low alloyed	<1300	180	200	0.9	0.75
3.1-3.3 high alloyed	<1400	165	180	0.8	0.7
K CASTINGS					
1.1 grey cast iron	<1000	240	215	0.9	0.8
T TITANIUM					
2.1-2.3 pure/alloyed	<1000	100	60	0.7	0.5

ADVICE | The values marked in turquoise are side applications!
 All fz/a values in the table for material group 1.1, consider factors for the other groups!
 When helical, reduce fz by 50 %.
 The specified values represent starting values for a solid clamping situation.
 To determine the hmax values, please use the provided formula.
 For material groups M2.2 and M3.1, the use of cooling lubricant is recommended!

Material M 1.1

D1 mm 	L2 mm 	Immersion Angle α° 	ETC high dynamic 				ETC low dynamic 				Finishing 	
			fz (mm/Z)	ae = 0.07xD (mm)	ap (mm)	hmax (mm)	fz (mm/Z)	ae = 0.12xD (mm)	ap (mm)	hmax (mm)	fz (mm/Z)	ae (mm)
6	20	0.6°	0.07	0.42	L2max	0.0357	0.057	0.72	L2max	0.037	0.025	0.2
8	26	0.8°	0.09	0.56	L2max	0.0459	0.074	0.96	L2max	0.0481	0.03	0.2
10	32	0.8°	0.11	0.7	L2max	0.0561	0.090	1.2	L2max	0.0585	0.032	0.2
12	39	1°	0.13	0.84	L2max	0.0663	0.107	1.44	L2max	0.0695	0.034	0.2
16	51	1.2°	0.15	1.12	L2max	0.0765	0.123	1.92	L2max	0.0799	0.036	0.2
20	63	1.5°	0.17	1.4	L2max	0.0867	0.139	2.4	L2max	0.0903	0.038	0.2

Cooling	
Tolerance	e8
Coating	AlphaNox Navy X







Strategy	ETC	
Application		
Features	HA  ≠  4xD  	

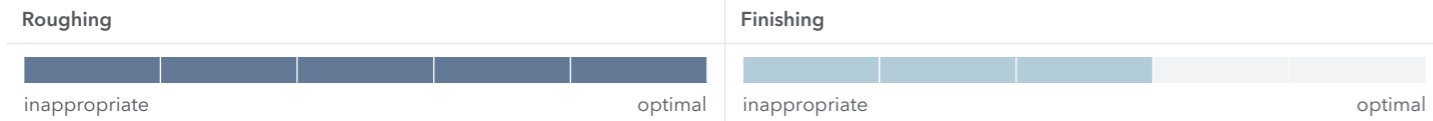
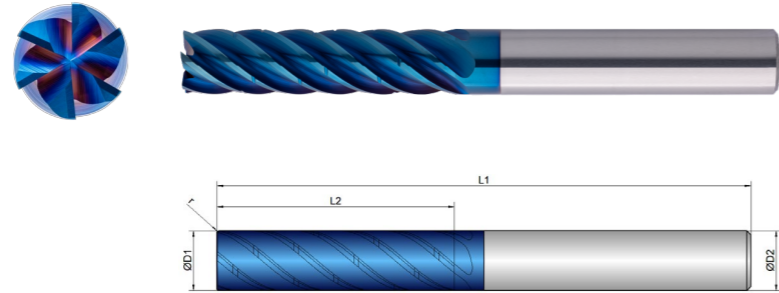

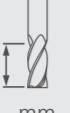



- 6 cutting edges for best performance and an excellent material removal rate
- Optimized cutting edges and chip chambers to effectively prevent built-up edges and chip stuck

- For roughing and finishing under ETC conditions
- For process reliable, helical immersion

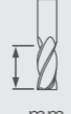
- Ideal chip evacuation, even with high feed rates and big radial depth of cutting



EXM1-M03-0123	D1 mm 	L2 mm 	L1 mm 	D2 mm 	z # 	r mm 	
6	6.0	26.0	67.0	6.0	6	0.15	40
6/0,5	6.0	26.0	67.0	6.0	6	0.50	40
6/1	6.0	26.0	67.0	6.0	6	1.00	40
6/2	6.0	26.0	67.0	6.0	6	2.00	40
8	8.0	34.0	75.0	8.0	6	0.20	40
8/0,5	8.0	34.0	75.0	8.0	6	0.50	40
8/1	8.0	34.0	75.0	8.0	6	1.00	40
8/2	8.0	34.0	75.0	8.0	6	2.00	40
10	10.0	42.0	90.0	10.0	6	0.20	40
10/0,5	10.0	42.0	90.0	10.0	6	0.50	40
10/1	10.0	42.0	90.0	10.0	6	1.00	40

EXM1-M03-0123	D1 mm 	L2 mm 	L1 mm 	D2 mm 	z # 	r mm 	
10/2	10.0	42.0	90.0	10.0	6	2.00	40
12	12.0	51.0	100.0	12.0	6	0.20	40
12/0,5	12.0	51.0	100.0	12.0	6	0.50	40
12/1	12.0	51.0	100.0	12.0	6	1.00	40
12/2	12.0	51.0	100.0	12.0	6	2.00	40
16	16.0	67.0	125.0	16.0	6	0.30	40
16/0,5	16.0	67.0	125.0	16.0	6	0.50	40
16/1	16.0	67.0	125.0	16.0	6	1.00	40
16/2	16.0	67.0	125.0	16.0	6	2.00	40
20	20.0	83.0	150.0	20.0	6	0.30	40
20/0,5	20.0	83.0	150.0	20.0	6	0.50	40
20/1	20.0	83.0	150.0	20.0	6	1.00	40
20/2	20.0	83.0	150.0	20.0	6	2.00	40



Download Catalog Pages (PDF)

Material	Strength (N/mm ²)	ETC	Finishing	Materialgroup Factor fz	Materialgroup Factor ae ETC
		Vc = m/min	Vc = m/min		
M STAINLESS STEEL					
1.1 ferritic/martensitic	<850	176	90	1	1
2.1 austenitic	<650	161	80	0.95	0.9
2.2 austenitic	<750	142	75	0.9	0.8
3.1 DUPLEX STEEL super austenitic	<1100	124	65	0.85	0.7
P STEEL					
1.1-1.5 unalloyed	<1100	240	230	1	1
2.1-2.4 low alloyed	<1300	180	200	0.9	0.75
3.1-3.3 high alloyed	<1400	165	180	0.8	0.7
K CASTINGS					
1.1 grey cast iron	<1000	240	215	0.9	0.8
T TITANIUM					
2.1-2.3 pure/alloyed	<1000	100	60	0.7	0.5

ADVICE | The values marked in turquoise are side applications!
 All fz/a values in the table for material group 1.1, consider factors for the other groups!
 When helical, reduce fz by 50 %.
 The specified values represent starting values for a solid clamping situation.
 To determine the hmax values, please use the provided formula.
 For material groups M2.2 and M3.1, the use of cooling lubricant is recommended!
 For coarser roughing operations and ETC operations, we recommend a Weldon in conjunction with a Weldon chuck.

Material M 1.1

D1	L2	Immersion Angle	ETC high dynamic				ETC low dynamic				Finishing	
			fz (mm/Z)	ae = 0.05xD (mm)	ap (mm)	hmax (mm)	fz (mm/Z)	ae = 0.1xD (mm)	ap (mm)	hmax (mm)	fz (mm/Z)	ae (mm)
6	26	0.4°	0.06	0.3	L2max	0.0262	0.049	0.6	L2max	0.0294	0.025	0.2
8	34	0.6°	0.08	0.4	L2max	0.0349	0.066	0.8	L2max	0.0396	0.03	0.2
10	42	0.6°	0.1	0.5	L2max	0.0436	0.082	1	L2max	0.0492	0.032	0.2
12	51	0.8°	0.12	0.6	L2max	0.0523	0.098	1.2	L2max	0.0588	0.034	0.2
16	67	1°	0.14	0.8	L2max	0.061	0.115	1.6	L2max	0.069	0.036	0.2
20	83	1.3°	0.16	1	L2max	0.0697	0.131	2	L2max	0.0786	0.038	0.2



STILL CAN'T FIND A SUITABLE MILLING CUTTER?

No problem - simply customize an existing tool. Using our configurator for special milling cutters, you can customize existing tools to your needs in an instant or create your own tools based on predefined types.



WE WILL RESPOND TO ALL REQUESTS SUBMITTED VIA THE CONFIGURATOR WITHIN ONE WORKING DAY AT THE LATEST

Cooling	
Tolerance	e8
Coating	AlphaNox Navy X

Strategy	ETC		
Application			
Features	HB	≠	4xD

- 6 cutting edges for best performance and an excellent material removal rate
- Optimized cutting edges and chip chambers to effectively prevent built-up edges and chip stuck

- For roughing and finishing under ETC conditions
- For process reliable, helical immersion

- Ideal chip evacuation, even with high feed rates and big radial depth of cutting

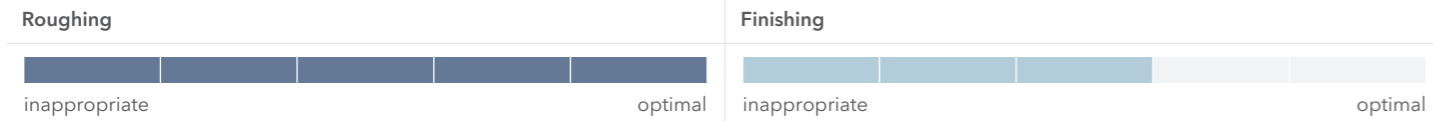
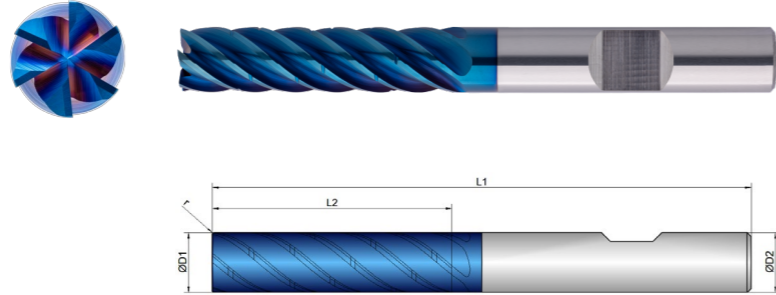

EXM1-M03-0124	D1 mm ∅	L2 mm	L1 mm	D2 mm ∅	z #	r mm	
6	6.0	26.0	67.0	6.0	6	0.15	40
6/0,5	6.0	26.0	67.0	6.0	6	0.50	40
6/1	6.0	26.0	67.0	6.0	6	1.00	40
6/2	6.0	26.0	67.0	6.0	6	2.00	40
8	8.0	34.0	75.0	8.0	6	0.20	40
8/0,5	8.0	34.0	75.0	8.0	6	0.50	40
8/1	8.0	34.0	75.0	8.0	6	1.00	40
8/2	8.0	34.0	75.0	8.0	6	2.00	40
10	10.0	42.0	90.0	10.0	6	0.20	40
10/0,5	10.0	42.0	90.0	10.0	6	0.50	40
10/1	10.0	42.0	90.0	10.0	6	1.00	40

EXM1-M03-0124	D1 mm ∅	L2 mm	L1 mm	D2 mm ∅	z #	r mm	
10/2	10.0	42.0	90.0	10.0	6	2.00	40
12	12.0	51.0	100.0	12.0	6	0.20	40
12/0,5	12.0	51.0	100.0	12.0	6	0.50	40
12/1	12.0	51.0	100.0	12.0	6	1.00	40
12/2	12.0	51.0	100.0	12.0	6	2.00	40
16	16.0	67.0	125.0	16.0	6	0.30	40
16/0,5	16.0	67.0	125.0	16.0	6	0.50	40
16/1	16.0	67.0	125.0	16.0	6	1.00	40
16/2	16.0	67.0	125.0	16.0	6	2.00	40
20	20.0	83.0	150.0	20.0	6	0.30	40
20/0,5	20.0	83.0	150.0	20.0	6	0.50	40
20/1	20.0	83.0	150.0	20.0	6	1.00	40
20/2	20.0	83.0	150.0	20.0	6	2.00	40



Download Catalog Pages (PDF)

Material	Strength (N/mm ²)	ETC	Finishing	Materialgroup Factor fz	Materialgroup Factor ae ETC
		Vc = m/min	Vc = m/min		
M STAINLESS STEEL					
1.1 ferritic/martensitic	<850	176	90	1	1
2.1 austenitic	<650	161	80	0.95	0.9
2.2 austenitic	<750	142	75	0.9	0.8
3.1 DUPLEX STEEL super austenitic	<1100	124	65	0.85	0.7
P STEEL					
1.1-1.5 unalloyed	<1100	240	230	1	1
2.1-2.4 low alloyed	<1300	180	200	0.9	0.75
3.1-3.3 high alloyed	<1400	165	180	0.8	0.7
K CASTINGS					
1.1 grey cast iron	<1000	240	215	0.9	0.8
T TITANIUM					
2.1-2.3 pure/alloyed	<1000	100	60	0.7	0.5

ADVICE | The values marked in turquoise are side applications!
 All fz/a values in the table for material group 1.1, consider factors for the other groups!
 When helical, reduce fz by 50 %.
 The specified values represent starting values for a solid clamping situation.
 To determine the hmax values, please use the provided formula.
 For material groups M2.2 and M3.1, the use of cooling lubricant is recommended!

Material M 1.1

D1	L2	Immersion Angle	ETC high dynamic				ETC low dynamic				Finishing	
			fz (mm/Z)	ae = 0.05xD (mm)	ap (mm)	hmax (mm)	fz (mm/Z)	ae = 0.1xD (mm)	ap (mm)	hmax (mm)	fz (mm/Z)	ae (mm)
6	26	0.4°	0.06	0.3	L2max	0.0262	0.049	0.6	L2max	0.0294	0.025	0.2
8	34	0.6°	0.08	0.4	L2max	0.0349	0.066	0.8	L2max	0.0396	0.03	0.2
10	42	0.6°	0.1	0.5	L2max	0.0436	0.082	1	L2max	0.0492	0.032	0.2
12	51	0.8°	0.12	0.6	L2max	0.0523	0.098	1.2	L2max	0.0588	0.034	0.2
16	67	1°	0.14	0.8	L2max	0.061	0.115	1.6	L2max	0.069	0.036	0.2
20	83	1.3°	0.16	1	L2max	0.0697	0.131	2	L2max	0.0786	0.038	0.2

DO YOU HAVE BLUNT MILLING CUTTERS THAT URGENTLY NEED REGRINDING?



DISCOVER OUR H&V REGRINDING SERVICE

... and have your tools reconditioned to their original state!



Cooling	
Tolerance	e8
Coating	AlphaNox Navy X

Strategy	ETC			 Expert
Application				
Features	HA	≠	5xD	

- 6 cutting edges for best performance and an excellent material removal rate
- Optimized cutting edges and chip chambers to effectively prevent built-up edges and chip stuck
- Ideal chip evacuation, even with high feed rates and big radial depth of cutting
- For roughing and finishing under ETC conditions
- For process reliable, helical immersion

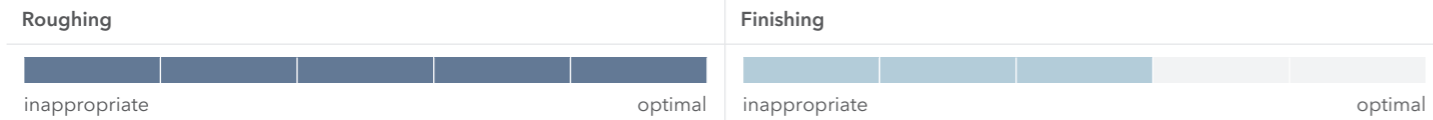
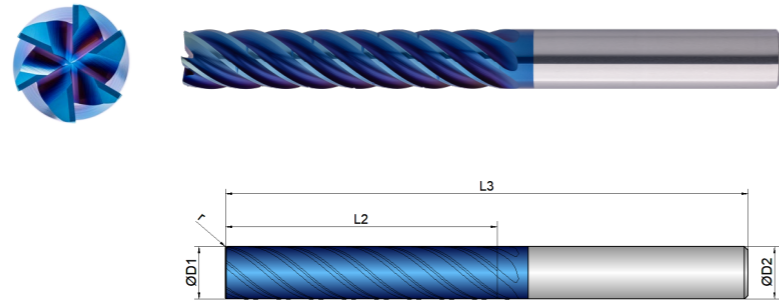

EXM1-M03-0133	D1 mm 	L2 mm 	L1 mm 	D2 mm 	z # 	r mm 	
6	6.0	31.0	75.0	6.0	6	0.15	40
8	8.0	42.0	90.0	8.0	6	0.20	40
10	10.0	52.0	100.0	10.0	6	0.20	40
12	12.0	62.0	119.0	12.0	6	0.25	40
16	16.0	82.0	134.0	16.0	6	0.30	40
20	20.0	102.0	160.0	20.0	6	0.30	40



Download Catalog Pages (PDF)

Material	Strength (N/mm ²)	ETC Vc = m/min	Finishing Vc = m/min	Materialgroup Factor fz	Materialgroup Factor ae ETC
M STAINLESS STEEL					
1.1 ferritic/martensitic	<850	158	85	1	1
2.1 austenitic	<650	145	75	0.95	0.9
2.2 austenitic	<750	128	70	0.9	0.8
3.1 DUPLEX STEEL super austenitic	<1100	112	60	0.85	0.7
P STEEL					
1.1-1.5 unalloyed	<1100	216	210	1	1
2.1-2.4 low alloyed	<1300	162	180	0.9	0.75
3.1-3.3 high alloyed	<1400	148	160	0.8	0.7
K CASTINGS					
1.1 grey cast iron	<1000	216	195	0.9	0.8
T TITANIUM					
2.1-2.3 pure/alloyed	<1000	90	55	0.7	0.5

ADVICE | The values marked in turquoise are side applications!
 All fz/a values in the table for material group 1.1, consider factors for the other groups!
 When helical, reduce fz by 50 %.
 The specified values represent starting values for a solid clamping situation.
 To determine the hmax values, please use the provided formula.
 For material groups M2.2 and M3.1, the use of cooling lubricant is recommended!
 For coarser roughing operations and ETC operations, we recommend a Weldon in conjunction with a Weldon chuck.

Material M 1.1

D1 mm 	L2 mm 	Immersion Angle α° 	ETC high dynamic 				ETC low dynamic 				Finishing 		
			fz (mm/Z)	ae = 0.04xD (mm)	ap (mm)	hmax (mm)	fz (mm/Z)	ae = 0.8xD (mm)	ap (mm)	hmax (mm)	fz (mm/Z)	ae (mm)	ap (mm)
6	31	0.3°	0.05	0.24	L2max	0.0196	0.036	0.48	L2max	0.0195	0.022	0.2	L2max
8	42	0.4°	0.072	0.32	L2max	0.0282	0.053	0.64	L2max	0.0288	0.027	0.2	L2max
10	52	0.4°	0.09	0.4	L2max	0.0353	0.065	0.8	L2max	0.0353	0.029	0.2	L2max
12	62	0.6°	0.11	0.48	L2max	0.0431	0.081	0.96	L2max	0.0439	0.031	0.2	L2max
16	82	0.8°	0.125	0.64	L2max	0.049	0.093	1.28	L2max	0.0505	0.033	0.2	L2max
20	102	1°	0.14	0.8	L2max	0.0549	0.104	1.6	L2max	0.0564	0.035	0.2	L2max

Cooling	
Tolerance	e8
Coating	AlphaNox Navy X

Strategy	ETC	
Application		
Features	HB, ≠, 5xD,	

- 6 cutting edges for best performance and an excellent material removal rate
- Optimized cutting edges and chip chambers to effectively prevent built-up edges and chip stuck
- Ideal chip evacuation, even with high feed rates and big radial depth of cutting
- For roughing and finishing under ETC conditions
- For process reliable, helical immersion

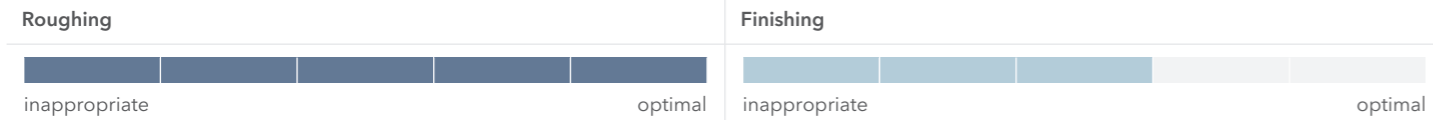
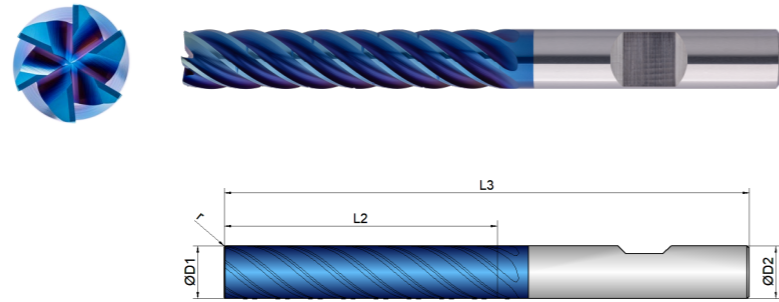

EXM1-M03-0134	D1 mm 	L2 mm 	L1 mm 	D2 mm 	z # 	r mm 	
6	6.0	31.0	75.0	6.0	6	0.15	40
8	8.0	42.0	90.0	8.0	6	0.20	40
10	10.0	52.0	100.0	10.0	6	0.20	40
12	12.0	62.0	119.0	12.0	6	0.25	40
16	16.0	82.0	134.0	16.0	6	0.30	40
20	20.0	102.0	160.0	20.0	6	0.30	40



Download Catalog Pages (PDF)

Material	Strength (N/mm ²)	ETC Vc = m/min	Finishing Vc = m/min	Materialgroup Factor fz	Materialgroup Factor ae ETC
M STAINLESS STEEL					
1.1 ferritic/martensitic	<850	158	85	1	1
2.1 austenitic	<650	145	75	0.95	0.9
2.2 austenitic	<750	128	70	0.9	0.8
3.1 DUPLEX STEEL super austenitic	<1100	112	60	0.85	0.7
P STEEL					
1.1-1.5 unalloyed	<1100	216	210	1	1
2.1-2.4 low alloyed	<1300	162	180	0.9	0.75
3.1-3.3 high alloyed	<1400	148	160	0.8	0.7
K CASTINGS					
1.1 grey cast iron	<1000	216	195	0.9	0.8
T TITANIUM					
2.1-2.3 pure/alloyed	<1000	90	55	0.7	0.5

ADVICE | The values marked in turquoise are side applications!
 All fz/a values in the table for material group 1.1, consider factors for the other groups!
 When helical, reduce fz by 50%.
 The specified values represent starting values for a solid clamping situation.
 To determine the hmax values, please use the provided formula.
 For material groups M2.2 and M3.1, the use of cooling lubricant is recommended!

Material M 1.1

D1 mm 	L2 mm 	Immersion Angle α° 	ETC high dynamic 				ETC low dynamic 				Finishing 		
			fz (mm/Z)	ae = 0.04xD (mm)	ap (mm)	hmax (mm)	fz (mm/Z)	ae = 0.8xD (mm)	ap (mm)	hmax (mm)	fz (mm/Z)	ae (mm)	ap (mm)
6	31	0.3°	0.05	0.24	L2max	0.0196	0.036	0.48	L2max	0.0195	0.022	0.2	L2max
8	42	0.4°	0.072	0.32	L2max	0.0282	0.053	0.64	L2max	0.0288	0.027	0.2	L2max
10	52	0.4°	0.09	0.4	L2max	0.0353	0.065	0.8	L2max	0.0353	0.029	0.2	L2max
12	62	0.6°	0.11	0.48	L2max	0.0431	0.081	0.96	L2max	0.0439	0.031	0.2	L2max
16	82	0.8°	0.125	0.64	L2max	0.049	0.093	1.28	L2max	0.0505	0.033	0.2	L2max
20	102	1°	0.14	0.8	L2max	0.0549	0.104	1.6	L2max	0.0564	0.035	0.2	L2max

Cooling	
Tolerance	e8
Coating	AlphaNox Navy X

Strategy	HPC	
Application		
Features	HA \neq 3xD	

- Slightly conical tool core and special helical pitch
 - 7 specially finished cutting edges with optimized geometry
 - Face-Finish-bevel for smooth workpiece surfaces
-
- 7 cutting edges for highest feed rates
-
- For excellent surfaces and maximum dimensional accuracy

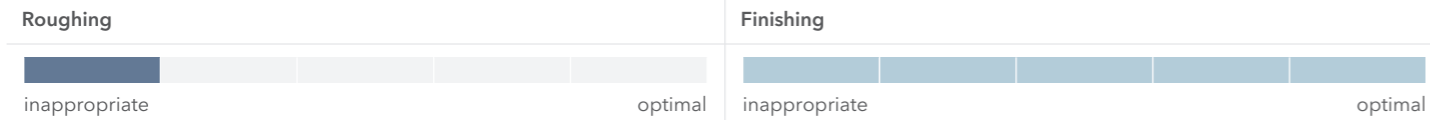
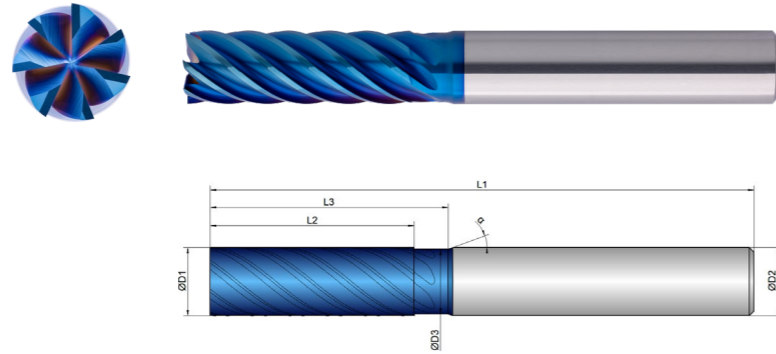

EXM1-M04-0033	D1 mm Ø	D3 mm Ø	L2 mm	L3 mm	L1 mm	D2 mm Ø	z #	α °	
6	6.0	5.8	20.0	25.0	63.0	6.0	7	39	20
8	8.0	7.8	26.0	30.0	70.0	8.0	7	39	20
10	10.0	9.5	32.0	36.0	80.0	10.0	7	39	20
12	12.0	11.5	39.0	46.0	93.0	12.0	7	39	20
16	16.0	15.5	52.0	57.0	110.0	16.0	7	39	20
20	20.0	19.5	64.0	72.0	125.0	20.0	7	39	20



Download Catalog Pages (PDF)

Material	Strength (N/mm ²)	Vc = m/min	Materialgroup	Factor fz
M STAINLESS STEEL				
1.1	ferritic/martensitic	<850	90	1
2.1	austenitic	<650	80	0.95
2.2	austenitic	<750	75	0.9
3.1	DUPLIX STEEL super austenitic	<1100	65	0.85
P STEEL				
1.1-1.5	unalloyed	<1100	230	1
2.1-2.4	low alloyed	<1300	200	0.9
3.1-3.3	high alloyed	<1400	180	0.8
K CASTINGS				
1.1	grey cast iron	<1000	215	0.9
T TITANIUM				
2.1-2.3	pure/alloyed	<1000	60	0.7

ADVICE | The values marked in turquoise are side applications!
 All fz/a values in the table for material group 1.1, consider factors for the other groups!
 The specified values represent starting values for finishing.
 Depending on the material, it may be necessary to change the Vc or Fz value.
 For a very good straightness of the surface, an additional blank path is recommended.
 For material groups M2.2 and M3.1, the use of cooling lubricant is recommended!

Material M 1.1

D1 Ø	L2 mm	Immersion Angle α°	Semi Finishing 		Finishing 	
			fz (mm)	ae (mm)	fz (mm/Z)	ae (mm)
6	26		0.038	0.2	0.028	0.2
8	34		0.042	0.2	0.03	0.2
10	42		0.044	0.2	0.032	0.2
12	51		0.046	0.2	0.034	0.2
16	67		0.048	0.2	0.036	0.2
20	84		0.05	0.2	0.038	0.2

Cooling	
Tolerance	e8
Coating	AlphaNox Navy X

Strategy	HPC	
Application		
Features	HA \neq 4xD	

- Slightly conical tool core and special helical pitch
 - 7 specially finished cutting edges with optimized geometry
 - Face-Finish-bevel for smooth workpiece surfaces
-
- 7 cutting edges for highest feed rates
-
- For excellent surfaces and maximum dimensional accuracy

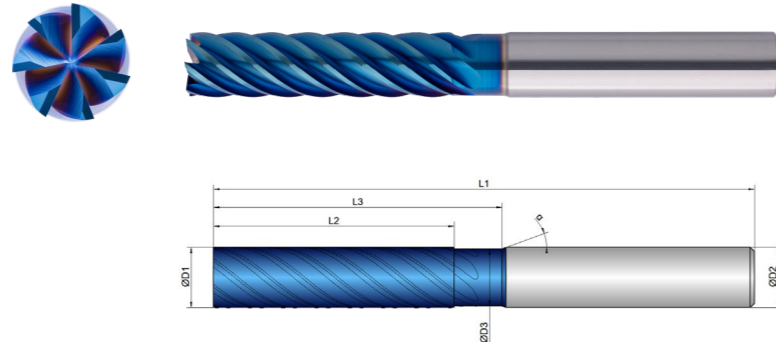

Roughing					Finishing				
inappropriate					inappropriate				
optimal					optimal				

	D1	D3	L2	L3	L1	D2	z	α	
EXM1-M04-0043									
	mm \emptyset	mm \emptyset	mm	mm	mm	mm \emptyset	#	$^{\circ}$	
6	6.0	5.8	26.0	32.0	63.0	6.0	7	39	20
8	8.0	7.8	34.0	40.0	80.0	8.0	7	39	20
10	10.0	9.5	42.0	48.0	90.0	10.0	7	39	20
12	12.0	11.5	51.0	56.0	100.0	12.0	7	39	20
16	16.0	15.5	67.0	72.0	125.0	16.0	7	39	20
20	20.0	19.5	84.0	90.0	150.0	20.0	7	39	20



Download Catalog Pages (PDF)

Material	Strength (N/mm ²)	Vc = m/min	Materialgroup	Factor fz
M STAINLESS STEEL				
1.1	ferritic/martensitic	<850	90	1
2.1	austenitic	<650	80	0.95
2.2	austenitic	<750	75	0.9
3.1	DUPLIX STEEL super austenitic	<1100	65	0.85
P STEEL				
1.1-1.5	unalloyed	<1100	230	1
2.1-2.4	low alloyed	<1300	200	0.9
3.1-3.3	high alloyed	<1400	180	0.8
K CASTINGS				
1.1	grey cast iron	<1000	215	0.9
T TITANIUM				
2.1-2.3	pure/alloyed	<1000	60	0.7

ADVICE | The values marked in turquoise are side applications!
 All fz/a values in the table for material group 1.1, consider factors for the other groups!
 The specified values represent starting values for finishing.
 Depending on the material, it may be necessary to change the Vc or Fz value.
 For a very good straightness of the surface, an additional blank path is recommended.
 For material groups M2.2 and M3.1, the use of cooling lubricant is recommended!

Material M 1.1

D1	L2	Immersion Angle	Semi Finishing		Finishing	
			fz (mm)	ae (mm)	fz (mm/Z)	ae (mm)
\emptyset	mm	α°				
6	20		0.036	0.2	0.026	0.2
8	26		0.04	0.2	0.028	0.2
10	32		0.042	0.2	0.03	0.2
12	39		0.044	0.2	0.032	0.2
16	52		0.046	0.2	0.034	0.2
20	64		0.048	0.2	0.036	0.2

Cooling	
Tolerance	e8
Coating	AlphaNox Navy X

Strategy	HPC	
Application		
Features	HA \neq 5xD	

- Slightly conical tool core and special helical pitch
 - 7 specially finished cutting edges with optimized geometry
 - Face-Finish-bevel for smooth workpiece surfaces
-
- For excellent surfaces and maximum dimensional accuracy
-
- 7 cutting edges for highest feed rates

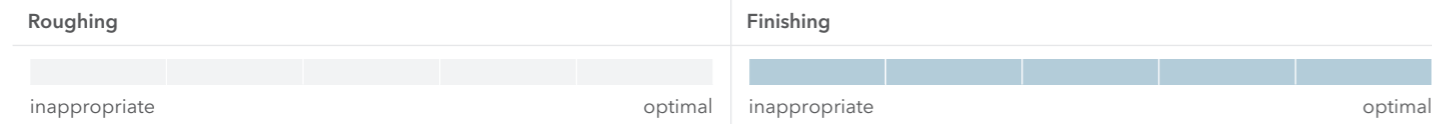
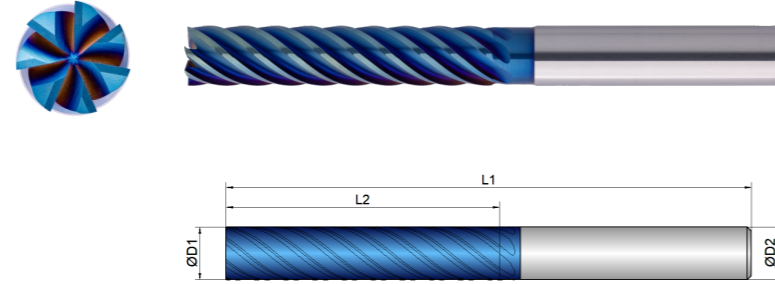

EXM1-M04-0053	D1	L2	L1	D2	z	°
	mm Ø	mm	mm	mm Ø	#	
6	6.0	31.0	75.0	6.0	7	39
8	8.0	42.0	90.0	8.0	7	39
10	10.0	52.0	100.0	10.0	7	39
12	12.0	62.0	119.0	12.0	7	39
16	16.0	82.0	134.0	16.0	7	39
20	20.0	102.0	160.0	20.0	7	39



Download Catalog Pages (PDF)

Material	Strength (N/mm ²)	Vc = m/min	
M STAINLESS STEEL			
1.1 ferritic/martensitic	<850	85	1
2.1 austenitic	<650	75	0.95
2.2 austenitic	<750	70	0.9
3.1 DUPLEX STEEL super austenitic	<1100	60	0.85
P STEEL			
1.1-1.5 unalloyed	<1100	210	1
2.1-2.4 low alloyed	<1300	180	0.9
3.1-3.3 high alloyed	<1400	160	0.8
K CASTINGS			
1.1 grey cast iron	<1000	195	0.9
T TITANIUM			
2.1-2.3 pure/alloyed	<1000	55	0.7

ADVICE | The values marked in turquoise are side applications! All fz/a values in the table for material group 1.1, consider factors for the other groups! The specified values represent starting values for finishing. Depending on the material, it may be necessary to change the Vc or Fz value. For a very good straightness of the surface, an additional blank path is recommended. For material groups M2.2 and M3.1, the use of cooling lubricant is recommended!

Material M 1.1

D1	L2	Immersion Angle	Semi Finishing			Finishing		
			fz (mm)	ae (mm)	ap (mm)	fz (mm/Z)	ae (mm)	ap (mm)
6	31		0.032	0.2	L2max	0.022	0.2	L2max
8	42		0.036	0.2	L2max	0.025	0.2	L2max
10	52		0.038	0.2	L2max	0.027	0.2	L2max
12	62		0.04	0.2	L2max	0.029	0.2	L2max
16	82		0.042	0.2	L2max	0.031	0.2	L2max
20	102		0.044	0.2	L2max	0.032	0.2	L2max

Cooling	
Tolerance	e8
Coating	AlphaNox Navy X

Strategy	ETC	HSC	HPC	
Application				
Features	HA	≠	2xD	

- Optimized microgeometry with higher vibration resistance and increased cutting edge stability
- Special unequal tooth pitch combined with variable helical pitch for smooth running
- Geometry for contour milling, high radial depth of cut and full slot milling up to 1xD
- Adapted face with two cutting edges to the center, for reliable helical immersion

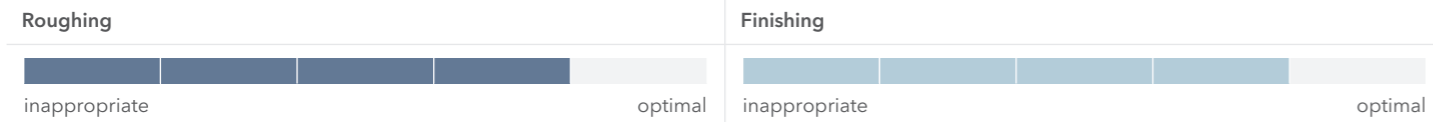
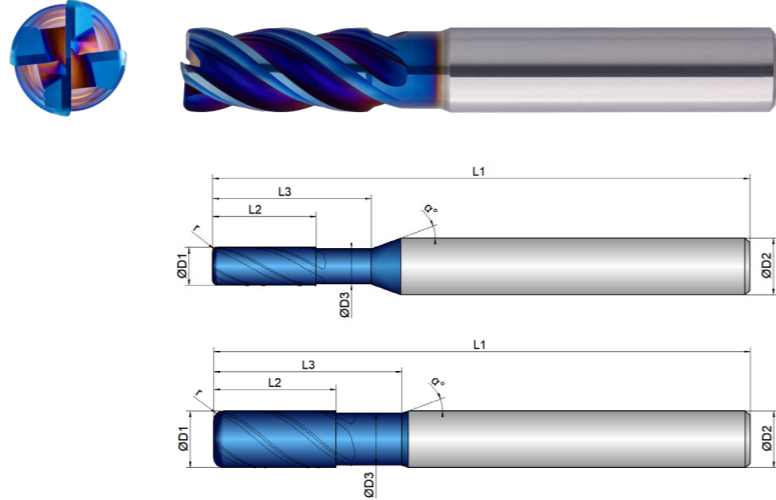

EXM1-M06-0053	D1 mm Ø	D3 mm Ø	L2 mm	L3 mm	L1 mm	D2 mm Ø	z #	r mm		α °
1/0,05	1.0	0.9	2.5	4.0	50.0	4.0	4	0.05	40	20
2/0,25	2.0	1.8	5.0	8.0	57.0	6.0	4	0.25	40	20
3/0,25	3.0	2.8	8.0	13.0	57.0	6.0	4	0.25	40	20
3/0,5	3.0	2.8	8.0	13.0	57.0	6.0	4	0.50	40	20
3/1	3.0	2.8	8.0	13.0	57.0	6.0	4	1.00	40	20
4/0,25	4.0	3.7	11.0	17.0	57.0	6.0	4	0.25	40	20
4/0,5	4.0	3.7	11.0	17.0	57.0	6.0	4	0.50	40	20
4/1	4.0	3.7	11.0	17.0	57.0	6.0	4	1.00	40	20
5/0,25	5.0	4.7	13.0	20.0	57.0	6.0	4	0.25	40	20
5/0,5	5.0	4.7	13.0	20.0	57.0	6.0	4	0.50	40	20
5/1	5.0	4.7	13.0	20.0	57.0	6.0	4	1.00	40	20

EXM1-M06-0053	D1 mm Ø	D3 mm Ø	L2 mm	L3 mm	L1 mm	D2 mm Ø	z #	r mm		α °
6/0,5	6.0	5.5	13.0	20.0	57.0	6.0	4	0.50	40	20
6/1	6.0	5.5	13.0	20.0	57.0	6.0	4	1.00	40	20
6/1,5	6.0	5.5	13.0	20.0	57.0	6.0	4	1.50	40	20
6/2	6.0	5.5	13.0	20.0	57.0	6.0	4	2.00	40	20
8/0,5	8.0	7.5	19.0	25.0	63.0	8.0	4	0.50	40	20
8/1	8.0	7.5	19.0	25.0	63.0	8.0	4	1.00	40	20
8/2	8.0	7.5	19.0	25.0	63.0	8.0	4	2.00	40	20
8/3	8.0	7.5	19.0	25.0	63.0	8.0	4	3.00	40	20
10/0,5	10.0	9.5	22.0	30.0	72.0	10.0	4	0.50	40	20
10/1	10.0	9.5	22.0	30.0	72.0	10.0	4	1.00	40	20
10/2	10.0	9.5	22.0	30.0	72.0	10.0	4	2.00	40	20
10/3	10.0	9.5	22.0	30.0	72.0	10.0	4	3.00	40	20
12/0,5	12.0	11.0	26.0	36.0	83.0	12.0	4	0.50	40	20
12/1	12.0	11.0	26.0	36.0	83.0	12.0	4	1.00	40	20
12/2	12.0	11.0	26.0	36.0	83.0	12.0	4	2.00	40	20
12/3	12.0	11.0	26.0	36.0	83.0	12.0	4	3.00	40	20
16/0,5	16.0	15.0	34.0	42.0	92.0	16.0	4	0.50	40	20
16/1	16.0	15.0	34.0	42.0	92.0	16.0	4	1.00	40	20
16/2	16.0	15.0	34.0	42.0	92.0	16.0	4	2.00	40	20
16/3	16.0	15.0	34.0	42.0	92.0	16.0	4	3.00	40	20
20/0,5	20.0	19.0	42.0	52.0	104.0	20.0	4	0.50	40	20
20/1	20.0	19.0	42.0	52.0	104.0	20.0	4	1.00	40	20
20/2	20.0	19.0	42.0	52.0	104.0	20.0	4	2.00	40	20
20/3	20.0	19.0	42.0	52.0	104.0	20.0	4	3.00	40	20
20/4	20.0	19.0	42.0	52.0	104.0	20.0	4	4.00	40	20



Download Catalog Pages (PDF)

Material	Strength (N/mm ²)	Full Slot	Side Milling	Finishing / Multipass Milling	ETC	Materialgroup Factor fz / a	Materialgroup Factor ae ETC
		Vc = m/min	Vc = m/min	Vc = m/min	Vc = m/min		
M STAINLESS STEEL							
1.1 ferritic/martensitic	<850	110	110	120	176	1	1
2.1 austenitic	<650	100	100	110	161	0.95	0.9
2.2 austenitic	<750	90	90	100	142	0.9	0.8
3.1 DUPLEX STEEL super austenitic	<1100	75	75	85	124	0.85	0.7
P STEEL							
1.1-1.5 unalloyed	<1100	180	180	190	240	1	1
2.1-2.4 low alloyed	<1300	145	145	155	180	0.9	0.75
3.1-3.3 high alloyed	<1400	135	135	145	165	0.8	0.7
K CASTINGS							
1.1 grey cast iron	<1000	200	200	210	240	0.9	0.8
T TITANIUM							
2.1-2.3 pure/alloyed	<1000	50	50	55	100	0.7	0.5

ADVICE | The values marked in turquoise are side applications!
 All fz/a values in the table for material group 1.1, consider factors for the other groups!
 When helical and ramping, use fz 30 % of side milling.
 The specified values represent starting values for a solid clamping situation.
 To determine the hmax values, please use the provided formula.
 For material groups M2.2 and M3.1, the use of cooling lubricant is recommended!
 For coarser roughing operations and ETC operations, we recommend a Weldon in conjunction with a Weldon chuck.

Material M 1.1

D1	L2	ETC				Multipass Milling		
		fz (mm/Z)	ae (mm)	ap (mm)	hmax (mm)	fz (mm/Z)	ae = 0.04xD (mm)	ap = 0.04xD (mm)
1	2.5	0.025	0.15	L2max	0.0179	0.018	0.04	0.04
2	5	0.03	0.25	L2max	0.0198	0.022	0.08	0.08
3	8	0.04	0.35	L2max	0.0257	0.03	0.12	0.12
4	11	0.05	0.55	L2max	0.0344	0.032	0.16	0.16
5	13	0.06	0.65	L2max	0.0404	0.04	0.2	0.2
6	13	0.07	0.8	L2max	0.0476	0.045	0.24	0.24
8	19	0.09	1	L2max	0.0595	0.06	0.32	0.32
10	22	0.105	1.2	L2max	0.0682	0.07	0.4	0.4
12	26	0.125	1.4	L2max	0.0803	0.085	0.48	0.48
16	34	0.15	1.8	L2max	0.0948	0.095	0.64	0.64
20	42	0.185	2	L2max	0.111	0.11	0.8	0.8

Material M 1.1

D1	L2	Immersion Angle	Full Slot			Side Milling			Finishing		
			fz (mm/Z)	ae = 1xD (mm)	ap = 1xD (mm)	fz (mm/Z)	ae = 0.3xD (mm)	ap (mm)	fz (mm/Z)	ae (mm)	ap (mm)
1	2.5	0.2°	0.008	1	1	0.018	0.3	L2max	0.012	0.1	L2max
2	5	0.3°	0.012	2	2	0.022	0.6	L2max	0.016	0.2	L2max
3	8	0.4°	0.018	3	3	0.03	0.9	L2max	0.018	0.2	L2max
4	11	0.5°	0.022	4	4	0.032	1.2	L2max	0.0192	0.2	L2max
5	13	0.6°	0.025	5	5	0.04	1.5	L2max	0.02	0.2	L2max
6	13	0.8°	0.03	6	6	0.045	1.8	L2max	0.025	0.2	L2max
8	19	1°	0.045	8	8	0.06	2.4	L2max	0.03	0.2	L2max
10	22	1.2°	0.05	10	10	0.07	3	L2max	0.035	0.2	L2max
12	26	1.4°	0.06	12	12	0.085	3.6	L2max	0.04	0.2	L2max
16	34	1.6°	0.065	16	16	0.095	4.8	L2max	0.045	0.2	L2max
20	42	2°	0.085	20	20	0.11	6	L2max	0.05	0.2	L2max

Cooling	
Tolerance	e8
Coating	AlphaNox Navy X

Strategy	ETC	HSC	HPC	
Application				
Features	HB	≠	2xD	

- Optimized microgeometry with higher vibration resistance and increased cutting edge stability
- Special unequal tooth pitch combined with variable helical pitch for smooth running
- Geometry for contour milling, high radial depth of cut and full slot milling up to 1xD
- Adapted face with two cutting edges to the center, for reliable helical immersion

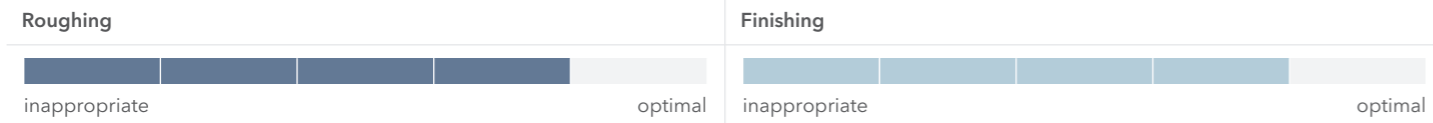
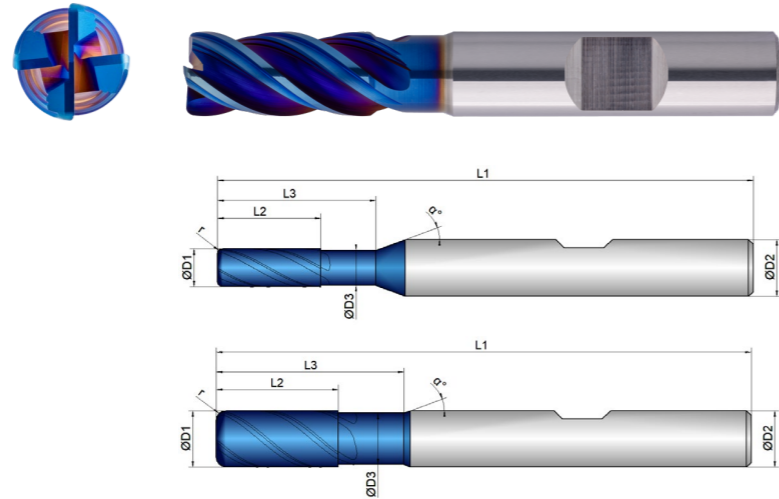

EXM1-M06-0054	D1 mm ∅	D3 mm ∅	L2 mm	L3 mm	L1 mm	D2 mm ∅	z #	r mm	α °
2/0,25	2.0	1.8	5.0	8.0	57.0	6.0	4	0.25	40
3/0,25	3.0	2.8	8.0	13.0	57.0	6.0	4	0.25	40
3/0,5	3.0	2.8	8.0	13.0	57.0	6.0	4	0.50	40
3/1	3.0	2.8	8.0	13.0	57.0	6.0	4	1.00	40
4/0,25	4.0	3.7	11.0	17.0	57.0	6.0	4	0.25	40
4/0,5	4.0	3.7	11.0	17.0	57.0	6.0	4	0.50	40
4/1	4.0	3.7	11.0	17.0	57.0	6.0	4	1.00	40
5/0,25	5.0	4.7	13.0	20.0	57.0	6.0	4	0.25	40
5/0,5	5.0	4.7	13.0	20.0	57.0	6.0	4	0.50	40
5/1	5.0	4.7	13.0	20.0	57.0	6.0	4	1.00	40
6/0,5	6.0	5.5	13.0	20.0	57.0	6.0	4	0.50	40

EXM1-M06-0054	D1 mm ∅	D3 mm ∅	L2 mm	L3 mm	L1 mm	D2 mm ∅	z #	r mm	α °
6/1	6.0	5.5	13.0	20.0	57.0	6.0	4	1.00	40
6/1,5	6.0	5.5	13.0	20.0	57.0	6.0	4	1.50	40
6/2	6.0	5.5	13.0	20.0	57.0	6.0	4	2.00	40
8/0,5	8.0	7.5	19.0	25.0	63.0	8.0	4	0.50	40
8/1	8.0	7.5	19.0	25.0	63.0	8.0	4	1.00	40
8/2	8.0	7.5	19.0	25.0	63.0	8.0	4	2.00	40
8/3	8.0	7.5	19.0	25.0	63.0	8.0	4	3.00	40
10/0,5	10.0	9.5	22.0	30.0	72.0	10.0	4	0.50	40
10/1	10.0	9.5	22.0	30.0	72.0	10.0	4	1.00	40
10/2	10.0	9.5	22.0	30.0	72.0	10.0	4	2.00	40
10/3	10.0	9.5	22.0	30.0	72.0	10.0	4	3.00	40
12/0,5	12.0	11.0	26.0	36.0	83.0	12.0	4	0.50	40
12/1	12.0	11.0	26.0	36.0	83.0	12.0	4	1.00	40
12/2	12.0	11.0	26.0	36.0	83.0	12.0	4	2.00	40
12/3	12.0	11.0	26.0	36.0	83.0	12.0	4	3.00	40
16/0,5	16.0	15.0	34.0	42.0	92.0	16.0	4	0.50	40
16/1	16.0	15.0	34.0	42.0	92.0	16.0	4	1.00	40
16/2	16.0	15.0	34.0	42.0	92.0	16.0	4	2.00	40
16/3	16.0	15.0	34.0	42.0	92.0	16.0	4	3.00	40
20/0,5	20.0	19.0	42.0	52.0	104.0	20.0	4	0.50	40
20/1	20.0	19.0	42.0	52.0	104.0	20.0	4	1.00	40
20/2	20.0	19.0	42.0	52.0	104.0	20.0	4	2.00	40
20/3	20.0	19.0	42.0	52.0	104.0	20.0	4	3.00	40
20/4	20.0	19.0	42.0	52.0	104.0	20.0	4	4.00	40



Download Catalog Pages (PDF)

Material	Strength (N/mm ²)	Full Slot	Side Milling	Finishing / Multipass Milling	ETC	Materialgroup Factor fz / a	Materialgroup Factor ae ETC
		Vc = m/min	Vc = m/min	Vc = m/min	Vc = m/min		
M STAINLESS STEEL							
1.1 ferritic/martensitic	<850	110	110	120	176	1	1
2.1 austenitic	<650	100	100	110	161	0.95	0.9
2.2 austenitic	<750	90	90	100	142	0.9	0.8
3.1 DUPLEX STEEL super austenitic	<1100	75	75	85	124	0.85	0.7
P STEEL							
1.1-1.5 unalloyed	<1100	180	180	190	240	1	1
2.1-2.4 low alloyed	<1300	145	145	155	180	0.9	0.75
3.1-3.3 high alloyed	<1400	135	135	145	165	0.8	0.7
K CASTINGS							
1.1 grey cast iron	<1000	200	200	210	240	0.9	0.8
T TITANIUM							
2.1-2.3 pure/alloyed	<1000	50	50	55	100	0.7	0.5

ADVICE | The values marked in turquoise are side applications!
 All fz/a values in the table for material group 1.1, consider factors for the other groups!
 When helical and ramping, use fz 30 % of side milling.
 The specified values represent starting values for a solid clamping situation.
 To determine the hmax values, please use the provided formula.
 For material groups M2.2 and M3.1, the use of cooling lubricant is recommended!

Material M 1.1

D1	L2	ETC				Multipass Milling		
		fz (mm/Z)	ae (mm)	ap (mm)	hmax (mm)	fz (mm/Z)	ae = 0.04xD (mm)	ap = 0.04xD (mm)
2	5	0.03	0.25	L2max	0.0198	0.022	0.08	0.08
3	8	0.04	0.35	L2max	0.0257	0.03	0.12	0.12
4	11	0.05	0.55	L2max	0.0344	0.032	0.16	0.16
5	13	0.06	0.65	L2max	0.0404	0.04	0.2	0.2
6	13	0.07	0.8	L2max	0.0476	0.045	0.24	0.24
8	19	0.09	1	L2max	0.0595	0.06	0.32	0.32
10	22	0.105	1.2	L2max	0.0682	0.07	0.4	0.4
12	26	0.125	1.4	L2max	0.0803	0.085	0.48	0.48
16	34	0.15	1.8	L2max	0.0948	0.095	0.64	0.64
20	42	0.185	2	L2max	0.111	0.11	0.8	0.8

Material M 1.1

D1	L2	Immersion Angle	Full Slot			Side Milling			Finishing		
			fz (mm/Z)	ae = 1xD (mm)	ap = 1xD (mm)	fz (mm/Z)	ae = 0.3xD (mm)	ap (mm)	fz (mm/Z)	ae (mm)	ap (mm)
2	5	0.3°	0.012	2	2	0.022	0.6	L2max	0.016	0.2	L2max
3	8	0.4°	0.018	3	3	0.03	0.9	L2max	0.018	0.2	L2max
4	11	0.5°	0.022	4	4	0.032	1.2	L2max	0.0192	0.2	L2max
5	13	0.6°	0.025	5	5	0.04	1.5	L2max	0.02	0.2	L2max
6	13	0.8°	0.03	6	6	0.045	1.8	L2max	0.025	0.2	L2max
8	19	1°	0.045	8	8	0.06	2.4	L2max	0.03	0.2	L2max
10	22	1.2°	0.05	10	10	0.07	3	L2max	0.035	0.2	L2max
12	26	1.4°	0.06	12	12	0.085	3.6	L2max	0.04	0.2	L2max
16	34	1.6°	0.065	16	16	0.095	4.8	L2max	0.045	0.2	L2max
20	42	2°	0.085	20	20	0.11	6	L2max	0.05	0.2	L2max

Cooling	
Tolerance	e8
Coating	AlphaNox Navy X

Strategy	ETC	HSC	HPC	 Expert
Application				
Features	HA	≠	2xD	

- Five cutting edges for high productivity with flexible use
- Unequal tooth pitch and variable helical pitch for perfect smoothness and a soft cut
- Adapted geometry for the special challenges of 3D multipass milling contours in different stainless steels
- Radius tolerance $r \leq 1.5 \text{ mm}$: $\pm 0.003 \text{ mm}$
- Radius tolerance $r > 1.5 \text{ mm}$: $\pm 0.005 \text{ mm}$

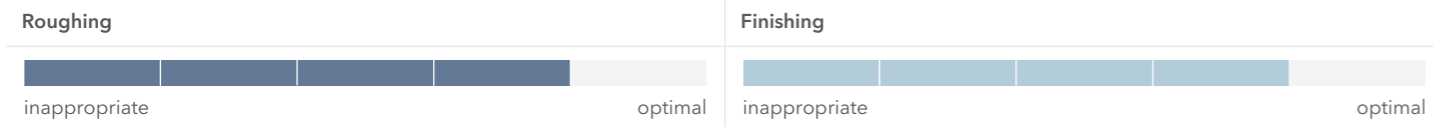
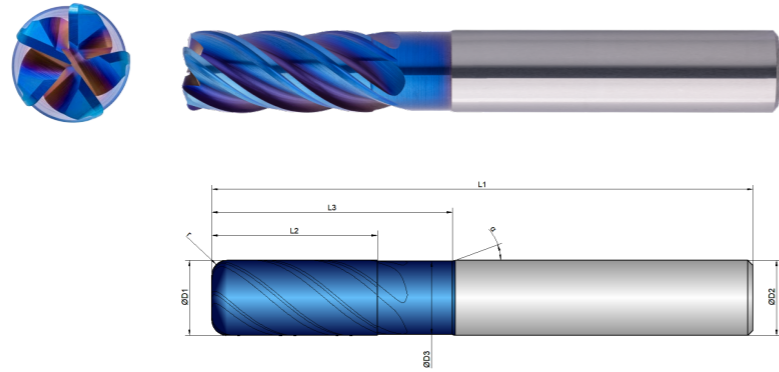

EXM1-M06-0123	D1 mm ∅	D3 mm ∅	L2 mm	L3 mm	L1 mm	D2 mm ∅	z #	r mm		α °
6/0,5	6.0	5.8	13.0	20.0	57.0	6.0	5	0.50	40	20
6/1	6.0	5.8	13.0	20.0	57.0	6.0	5	1.00	40	20
6/1,5	6.0	5.8	13.0	20.0	57.0	6.0	5	1.50	40	20
6/2	6.0	5.8	13.0	20.0	57.0	6.0	5	2.00	40	20
8/0,5	8.0	7.7	19.0	25.0	63.0	8.0	5	0.50	40	20
8/1	8.0	7.7	19.0	25.0	63.0	8.0	5	1.00	40	20
8/2	8.0	7.7	19.0	25.0	63.0	8.0	5	2.00	40	20
8/3	8.0	7.7	19.0	25.0	63.0	8.0	5	3.00	40	20
10/0,5	10.0	9.7	22.0	32.0	72.0	10.0	5	0.50	40	20
10/1	10.0	9.7	22.0	32.0	72.0	10.0	5	1.00	40	20
10/2	10.0	9.7	22.0	32.0	72.0	10.0	5	2.00	40	20
10/3	10.0	9.7	22.0	32.0	72.0	10.0	5	3.00	40	20

EXM1-M06-0123	D1 mm ∅	D3 mm ∅	L2 mm	L3 mm	L1 mm	D2 mm ∅	z #	r mm		α °
12/0,5	12.0	11.6	26.0	38.0	83.0	12.0	5	0.50	40	20
12/1	12.0	11.6	26.0	38.0	83.0	12.0	5	1.00	40	20
12/2	12.0	11.6	26.0	38.0	83.0	12.0	5	2.00	40	20
12/3	12.0	11.6	26.0	38.0	83.0	12.0	5	3.00	40	20
16/0,5	16.0	15.5	32.0	44.0	92.0	16.0	5	0.50	40	20
16/1	16.0	15.5	32.0	44.0	92.0	16.0	5	1.00	40	20
16/2	16.0	15.5	32.0	44.0	92.0	16.0	5	2.00	40	20
16/3	16.0	15.5	32.0	44.0	92.0	16.0	5	3.00	40	20
20/0,5	20.0	19.5	41.0	54.0	104.0	20.0	5	0.50	40	20
20/1	20.0	19.5	41.0	54.0	104.0	20.0	5	1.00	40	20
20/2	20.0	19.5	41.0	54.0	104.0	20.0	5	2.00	40	20
20/3	20.0	19.5	41.0	54.0	104.0	20.0	5	3.00	40	20
20/4	20.0	19.5	41.0	54.0	104.0	20.0	5	4.00	40	20



Download Catalog Pages (PDF)

Material	Strength (N/mm ²)	Side Milling	Finishing / Multipass Milling	ETC	Materialgroup Factor fz / a	Materialgroup Factor ae ETC
M STAINLESS STEEL		Vc = m/min	Vc = m/min	Vc = m/min		
1.1 ferritic/martensitic	<850	110	120	176	1	1
2.1 austenitic	<650	100	110	161	0.95	0.9
2.2 austenitic	<750	90	100	142	0.9	0.8
3.1 DUPLEX STEEL super austenitic	<1100	75	85	124	0.85	0.7
P STEEL		Vc = m/min	Vc = m/min	Vc = m/min		
1.1-1.5 unalloyed	<1100	180	190	240	1	1
2.1-2.4 low alloyed	<1300	145	155	180	0.9	0.75
3.1-3.3 high alloyed	<1400	135	145	165	0.8	0.7
K CASTINGS		Vc = m/min	Vc = m/min	Vc = m/min		
1.1 grey cast iron	<1000	200	210	240	0.9	0.8
T TITANIUM		Vc = m/min	Vc = m/min	Vc = m/min		
2.1-2.3 pure/alloyed	<1000	50	55	100	0.7	0.5

ADVICE | The values marked in turquoise are side applications!
 All fz/a values in the table for material group 1.1, consider factors for the other groups!
 When helical and ramping, use fz 30 % of side milling.
 The specified values represent starting values for a solid clamping situation.
 To determine the hmax values, please use the provided formula.
 For material groups M2.2 and M3.1, the use of cooling lubricant is recommended!
 For coarser roughing operations and ETC operations, we recommend a Weldon in conjunction with a Weldon chuck.

Material M 1.1

D1	L2	Immersion Angle	Side Milling			Finishing			ETC				Multipass Milling		
Ø	mm	α°	fz (mm/Z)	ae = 0.3xD (mm)	ap (mm)	fz (mm/Z)	ae (mm)	ap (mm)	fz (mm/Z)	ae (mm)	ap (mm)	hmax (mm)	fz (mm/Z)	ae = 0.04xD (mm)	ap = 0.04xD (mm)
6	13	0.6	0.04	1.8	L2max	0.02	0.2	L2max	0.064	0.7	L2max	0.0411	0.045	0.24	0.24
8	19	0.8	0.055	2.4	L2max	0.025	0.2	L2max	0.08	0.9	L2max	0.0506	0.06	0.32	0.32
10	22	0.8	0.065	3	L2max	0.03	0.2	L2max	0.096	1.1	L2max	0.0601	0.07	0.4	0.4
12	26	1	0.075	3.6	L2max	0.035	0.2	L2max	0.112	1.2	L2max	0.0672	0.085	0.48	0.48
16	32	1.2	0.085	4.8	L2max	0.04	0.2	L2max	0.136	1.5	L2max	0.0793	0.095	0.64	0.64
20	41	1.5	0.1	6	L2max	0.045	0.2	L2max	0.168	1.7	L2max	0.0937	0.11	0.8	0.8



STILL CAN'T FIND A SUITABLE MILLING CUTTER?

No problem - simply customize an existing tool. Using our configurator for special milling cutters, you can customize existing tools to your needs in an instant or create your own tools based on predefined types.



WE WILL RESPOND TO ALL REQUESTS SUBMITTED VIA THE CONFIGURATOR WITHIN ONE WORKING DAY AT THE LATEST

Cooling	
Tolerance	e8
Coating	AlphaNox Navy X

Strategy	ETC	HSC	HPC	 Expert
Application				
Features	HB	≠	2xD	

- Five cutting edges for high productivity with flexible use
- Unequal tooth pitch and variable helical pitch for perfect smoothness and a soft cut
- Adapted geometry for the special challenges of 3D multipass milling contours in different stainless steels
- Radius tolerance $r \leq 1.5 \text{ mm}$: $\pm 0.003 \text{ mm}$
- Radius tolerance $r > 1.5 \text{ mm}$: $\pm 0.005 \text{ mm}$

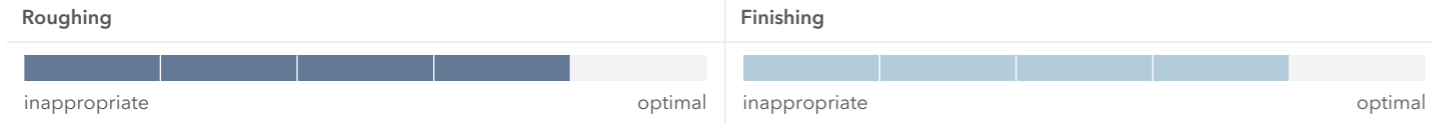
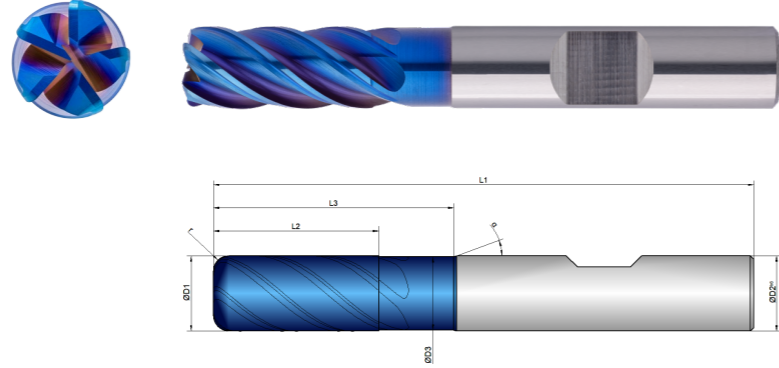

EXM1-M06-0124	D1 mm ∅	D3 mm ∅	L2 mm	L3 mm	L1 mm	D2 mm ∅	z #	r mm		α °
6/0,5	6.0	5.8	13.0	20.0	57.0	6.0	5	0.50	40	20
6/1	6.0	5.8	13.0	20.0	57.0	6.0	5	1.00	40	20
6/1,5	6.0	5.8	13.0	20.0	57.0	6.0	5	1.50	40	20
6/2	6.0	5.8	13.0	20.0	57.0	6.0	5	2.00	40	20
8/0,5	8.0	7.7	19.0	25.0	63.0	8.0	5	0.50	40	20
8/1	8.0	7.7	19.0	25.0	63.0	8.0	5	1.00	40	20
8/2	8.0	7.7	19.0	25.0	63.0	8.0	5	2.00	40	20
8/3	8.0	7.7	19.0	25.0	63.0	8.0	5	3.00	40	20
10/0,5	10.0	9.7	22.0	32.0	72.0	10.0	5	0.50	40	20
10/1	10.0	9.7	22.0	32.0	72.0	10.0	5	1.00	40	20
10/2	10.0	9.7	22.0	32.0	72.0	10.0	5	2.00	40	20
10/3	10.0	9.7	22.0	32.0	72.0	10.0	5	3.00	40	20

EXM1-M06-0124	D1 mm ∅	D3 mm ∅	L2 mm	L3 mm	L1 mm	D2 mm ∅	z #	r mm		α °
12/0,5	12.0	11.6	26.0	38.0	83.0	12.0	5	0.50	40	20
12/1	12.0	11.6	26.0	38.0	83.0	12.0	5	1.00	40	20
12/2	12.0	11.6	26.0	38.0	83.0	12.0	5	2.00	40	20
12/3	12.0	11.6	26.0	38.0	83.0	12.0	5	3.00	40	20
16/0,5	16.0	15.5	32.0	44.0	92.0	16.0	5	0.50	40	20
16/1	16.0	15.5	32.0	44.0	92.0	16.0	5	1.00	40	20
16/2	16.0	15.5	32.0	44.0	92.0	16.0	5	2.00	40	20
16/3	16.0	15.5	32.0	44.0	92.0	16.0	5	3.00	40	20
20/0,5	20.0	19.5	41.0	54.0	104.0	20.0	5	0.50	40	20
20/1	20.0	19.5	41.0	54.0	104.0	20.0	5	1.00	40	20
20/2	20.0	19.5	41.0	54.0	104.0	20.0	5	2.00	40	20
20/3	20.0	19.5	41.0	54.0	104.0	20.0	5	3.00	40	20
20/4	20.0	19.5	41.0	54.0	104.0	20.0	5	4.00	40	20



Download Catalog Pages (PDF)

Material	Strength (N/mm ²)	Side Milling	Finishing / Multipass Milling	ETC	Materialgroup Factor fz / a	Materialgroup Factor ae ETC
		Vc = m/min	Vc = m/min	Vc = m/min		
M STAINLESS STEEL						
1.1 ferritic/martensitic	<850	110	120	176	1	1
2.1 austenitic	<650	100	110	161	0.95	0.9
2.2 austenitic	<750	90	100	142	0.9	0.8
3.1 DUPLEX STEEL super austenitic	<1100	75	85	124	0.85	0.7
P STEEL						
1.1-1.5 unalloyed	<1100	180	190	240	1	1
2.1-2.4 low alloyed	<1300	145	155	180	0.9	0.75
3.1-3.3 high alloyed	<1400	135	145	165	0.8	0.7
K CASTINGS						
1.1 grey cast iron	<1000	200	210	240	0.9	0.8
T TITANIUM						
2.1-2.3 pure/alloyed	<1000	50	55	100	0.7	0.5

ADVICE | The values marked in turquoise are side applications!
 All fz/a values in the table for material group 1.1, consider factors for the other groups!
 When helical and ramping, use fz 30 % of side milling.
 The specified values represent starting values for a solid clamping situation.
 To determine the hmax values, please use the provided formula.
 For material groups M2.2 and M3.1, the use of cooling lubricant is recommended!

Material M 1.1

D1	L2	Immersion Angle	Side Milling			Finishing			ETC				Multipass Milling		
			fz	ae = 0.3xD	ap	fz	ae	ap	fz	ae	ap	hmax	fz	ae = 0.04xD	ap = 0.04xD
Ø	mm	α°	(mm/Z)	(mm)	(mm)	(mm/Z)	(mm)	(mm)	(mm/Z)	(mm)	(mm)	(mm)	(mm/Z)	(mm)	(mm)
6	13	0.6	0.04	1.8	L2max	0.02	0.2	L2max	0.064	0.7	L2max	0.0411	0.045	0.24	0.24
8	19	0.8	0.055	2.4	L2max	0.025	0.2	L2max	0.08	0.9	L2max	0.0506	0.06	0.32	0.32
10	22	0.8	0.065	3	L2max	0.03	0.2	L2max	0.096	1.1	L2max	0.0601	0.07	0.4	0.4
12	26	1	0.075	3.6	L2max	0.035	0.2	L2max	0.112	1.2	L2max	0.0672	0.085	0.48	0.48
16	32	1.2	0.085	4.8	L2max	0.04	0.2	L2max	0.136	1.5	L2max	0.0793	0.095	0.64	0.64
20	41	1.5	0.1	6	L2max	0.045	0.2	L2max	0.168	1.7	L2max	0.0937	0.11	0.8	0.8

DO YOU HAVE BLUNT MILLING CUTTERS THAT URGENTLY NEED REGRINDING?



DISCOVER OUR H&V REGRINDING SERVICE

... and have your tools reconditioned to their original state!



Cooling	
Tolerance	f8
Coating	AlphaNox Navy X

Strategy	HSC		
Application			
Features	HA		1xD



Download Catalog Pages (PDF)

	Roughing	Semi Finishing	Finishing	Materialgroup Factor fz
M STAINLESS STEEL				

- Adjusted core for smooth running
- Defined microlevel for support and stabilization
- Optimized cross cutting edge for maximum stability in the tool center
- For use in HSC milling
- For roughing and finishing
- Radius tolerance $r \leq 2 \text{ mm}$: $\pm 0.003 \text{ mm}$
- Radius tolerance $r > 2 \text{ mm}$: $\pm 0.005 \text{ mm}$

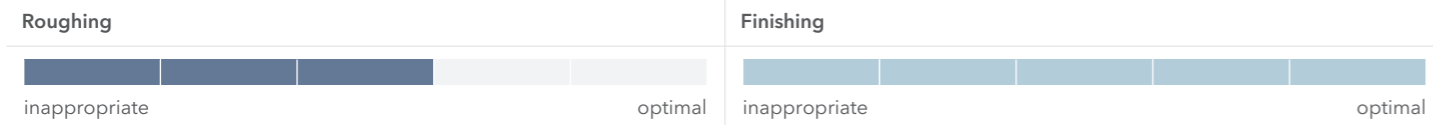
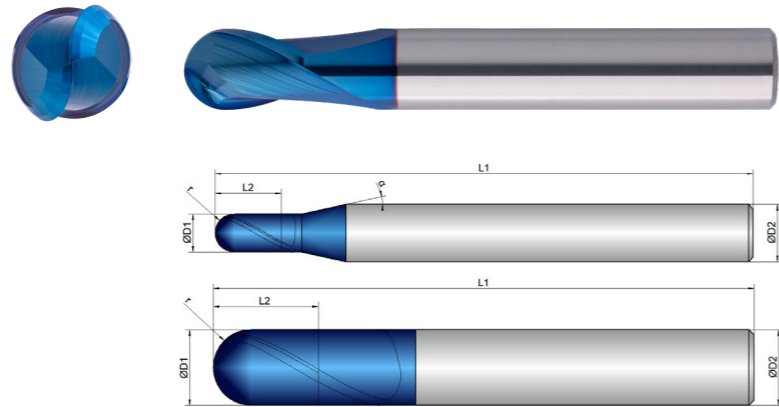

EXM1-M08-0003	D1	L2	L1	D2	z	r		α
	mm	mm	mm	mm	#	mm		
0,5	0.5	1.5	57.0	6.0	2	0.25	30	12
1	1.0	2.0	57.0	6.0	2	0.50	30	12
1,5	1.5	3.0	57.0	6.0	2	0.75	30	12
2	2.0	4.0	57.0	6.0	2	1.00	30	12
2,5	2.5	5.0	57.0	6.0	2	1.25	30	12
3	3.0	6.0	57.0	6.0	2	1.50	30	12
4	4.0	7.0	57.0	6.0	2	2.00	30	12
5	5.0	8.0	57.0	6.0	2	2.50	30	12
6	6.0	10.0	57.0	6.0	2	3.00	30	0
8	8.0	12.0	63.0	8.0	2	4.00	30	0
10	10.0	14.0	72.0	10.0	2	5.00	30	0
12	12.0	16.0	83.0	12.0	2	6.00	30	0

Material	Strength (N/mm ²)	Vc = m/min	Vc = m/min	Vc = m/min	Materialgroup Factor fz
M STAINLESS STEEL					
1.1 ferritic/martensitic	<850	140	140	140	1
2.1 austenitic	<650	120	120	120	0.95
2.2 austenitic	<750	100	100	100	0.9
3.1 DUPLEX STEEL super austenitic	<1100	80	80	80	0.85
P STEEL					
1.1-1.5 unalloyed	<1100	230	230	230	1
2.1-2.4 low alloyed	<1300	180	180	180	0.9
3.1-3.3 high alloyed	<1400	175	175	175	0.8
K CASTINGS					
1.1 grey cast iron	<1000	270	270	270	0.9
T TITANIUM					
2.1-2.3 pure/alloyed	<1000	60	60	60	0.7

ADVICE | The values marked in turquoise are side applications!
 All fz/a values in the table for material group 1.1, consider factors for the other groups!
 The specified values represent starting values.
 Depending on the material, it may be necessary to change the Vc or Fz value.
 For material groups M2.2 and M3.1, the use of cooling lubricant is recommended!

Material M 1.1

D1	Roughing			Semi Finishing			Finishing		
	fz (mm/Z)	ae 0.3xD (mm)	ap 0.3xD (mm)	fz (mm/Z)	ae 0.1xD (mm)	ap 0.1xD (mm)	fz (mm/Z)	ae 0.05xD (mm)	ap 0.05xD (mm)
0.5	0.010	0.15	0.15	0.017	0.05	0.05	0.015	0.025	0.025
1	0.016	0.3	0.3	0.029	0.1	0.1	0.025	0.05	0.05
1.5	0.020	0.45	0.45	0.035	0.15	0.15	0.03	0.075	0.075
2	0.029	0.6	0.6	0.052	0.2	0.2	0.045	0.1	0.1
2.5	0.033	0.75	0.75	0.058	0.25	0.25	0.05	0.125	0.125
3	0.036	0.9	0.9	0.063	0.3	0.3	0.055	0.15	0.15
4	0.042	1.2	1.2	0.075	0.4	0.4	0.065	0.2	0.2
5	0.049	1.5	1.5	0.086	0.5	0.5	0.075	0.25	0.25
6	0.059	1.8	1.8	0.104	0.6	0.6	0.09	0.3	0.3
8	0.072	2.4	2.4	0.127	0.8	0.8	0.11	0.4	0.4
10	0.085	3	3	0.150	1	1	0.13	0.5	0.5
12	0.091	3.6	3.6	0.161	1.2	1.2	0.14	0.6	0.6

Cooling	
Tolerance	f8
Coating	AlphaNox Navy X

Strategy	HSC		
Application			
Features	HA		



Download Catalog Pages (PDF)

	Roughing	Semi Finishing	Finishing	Materialgroup Factor fz

- Adjusted core for smooth running
- Defined microlevel for support and stabilization
- Optimized cross cutting edge for maximum stability in the tool center
- For use in HSC milling
- For roughing and finishing
- Long version for deeper cavities
- Radius tolerance $r \leq 2$ mm: ± 0.003 mm
- Radius tolerance $r > 2$ mm: ± 0.005 mm

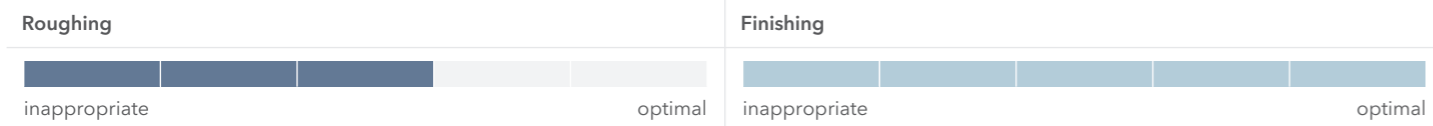
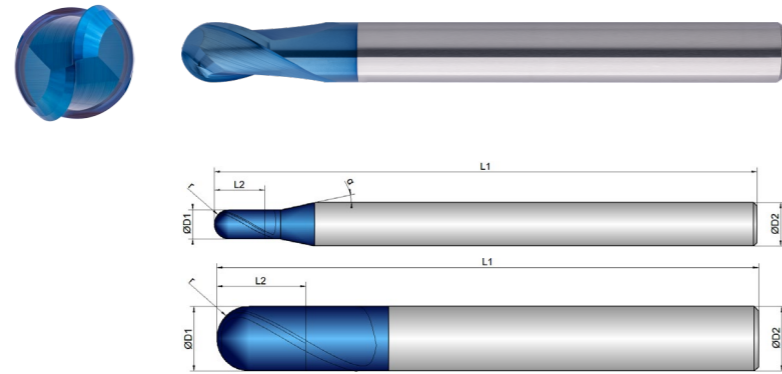

EXM1-M08-0013	D1 mm ø	L2 mm	L1 mm	D2 mm ø	z #	r mm	α °
0,5	0.5	1.5	75.0	6.0	2	0.25	12
1	1.0	2.0	75.0	6.0	2	0.50	12
1,5	1.5	3.0	75.0	6.0	2	0.75	12
2	2.0	4.0	75.0	6.0	2	1.00	12
2,5	2.5	5.0	75.0	6.0	2	1.25	12
3	3.0	6.0	75.0	6.0	2	1.50	12
4	4.0	7.0	75.0	6.0	2	2.00	12
5	5.0	8.0	75.0	6.0	2	2.50	12
6	6.0	10.0	75.0	6.0	2	3.00	0
8	8.0	12.0	75.0	8.0	2	4.00	0
10	10.0	14.0	85.0	10.0	2	5.00	0
12	12.0	16.0	100.0	12.0	2	6.00	0

Material	Strength (N/mm ²)	Vc = m/min	Vc = m/min	Vc = m/min	Materialgroup Factor fz
M STAINLESS STEEL					
1.1 ferritic/martensitic	<850	130	130	130	1
2.1 austenitic	<650	110	110	110	0.95
2.2 austenitic	<750	90	90	90	0.9
3.1 DUPLEX STEEL super austenitic	<1100	70	70	70	0.85
P STEEL					
1.1-1.5 unalloyed	<1100	210	210	210	1
2.1-2.4 low alloyed	<1300	160	160	160	0.9
3.1-3.3 high alloyed	<1400	155	155	155	0.8
K CASTINGS					
1.1 grey cast iron	<1000	240	240	240	0.9
T TITANIUM					
2.1-2.3 pure/alloyed	<1000	55	55	55	0.7

ADVICE | The values marked in turquoise are side applications!
 All fz/a values in the table for material group 1.1, consider factors for the other groups!
 The specified values represent starting values.
 Depending on the material, it may be necessary to change the Vc or Fz value.
 For material groups M2.2 and M3.1, the use of cooling lubricant is recommended!

Material M 1.1

D1 ø	Roughing			Semi Finishing			Finishing		
	fz (mm/Z)	ae 0.3xD (mm)	ap 0.3xD (mm)	fz (mm/Z)	ae 0.1xD (mm)	ap 0.1xD (mm)	fz (mm/Z)	ae 0.05xD (mm)	ap 0.05xD (mm)
0.5	0.010	0.15	0.15	0.017	0.05	0.05	0.015	0.025	0.025
1	0.016	0.3	0.3	0.029	0.1	0.1	0.025	0.05	0.05
1.5	0.020	0.45	0.45	0.035	0.15	0.15	0.03	0.075	0.075
2	0.029	0.6	0.6	0.052	0.2	0.2	0.045	0.1	0.1
2.5	0.033	0.75	0.75	0.058	0.25	0.25	0.05	0.125	0.125
3	0.036	0.9	0.9	0.063	0.3	0.3	0.055	0.15	0.15
4	0.042	1.2	1.2	0.075	0.4	0.4	0.065	0.2	0.2
5	0.049	1.5	1.5	0.086	0.5	0.5	0.075	0.25	0.25
6	0.059	1.8	1.8	0.104	0.6	0.6	0.09	0.3	0.3
8	0.072	2.4	2.4	0.127	0.8	0.8	0.11	0.4	0.4
10	0.085	3	3	0.150	1	1	0.13	0.5	0.5
12	0.091	3.6	3.6	0.161	1.2	1.2	0.14	0.6	0.6

Cooling	
Tolerance	f8
Coating	AlphaNox Navy X

Strategy	HSC	
Application		
Features	HA 1xD R	

- Adjusted wedge angle and helical pitch for smooth running and a soft cut
- Reinforced face geometry with a special finishing bevel for maximum performance and surface quality
- For use in HSC milling
- For roughing and finishing
- Highest machining performance due to four cutting edges
- Radius tolerance $r \leq 2$ mm: ± 0.003 mm
- Radius tolerance $r > 2$ mm: ± 0.005 mm

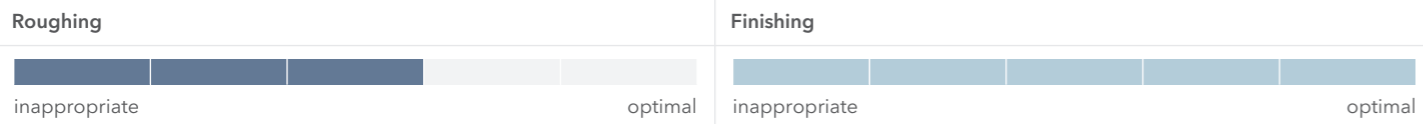
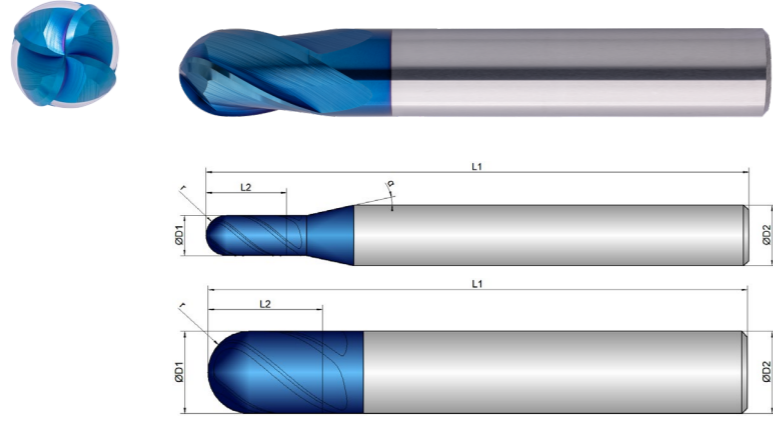

EXM1-M08-0203	D1 mm ø	L2 mm	L1 mm	D2 mm ø	z #	r mm	β °
3	3.0	5.0	54.0	6.0	4	1.50	40
4	4.0	8.0	54.0	6.0	4	2.00	40
5	5.0	9.0	54.0	6.0	4	2.50	40
6	6.0	10.0	54.0	6.0	4	3.00	40
8	8.0	12.0	59.0	8.0	4	4.00	40
10	10.0	14.0	66.0	10.0	4	5.00	40
12	12.0	16.0	73.0	12.0	4	6.00	40
16	16.0	22.0	82.0	16.0	4	8.00	40



Download Catalog Pages (PDF)

Material	Strength (N/mm ²)	Roughing	Semi Finishing	Finishing	Materialgroup Factor fz
		Vc = m/min	Vc = m/min	Vc = m/min	
M STAINLESS STEEL					
1.1 ferritic/martensitic	<850	140	130	130	1
2.1 austenitic	<650	120	110	110	0.95
2.2 austenitic	<750	100	90	90	0.9
3.1 DUPLEX STEEL super austenitic	<1100	80	70	70	0.85
P STEEL					
1.1-1.5 unalloyed	<1100	230	230	230	1
2.1-2.4 low alloyed	<1300	180	180	180	0.9
3.1-3.3 high alloyed	<1400	175	175	175	0.8
K CASTINGS					
1.1 grey cast iron	<1000	270	270	270	0.9
T TITANIUM					
2.1-2.3 pure/alloyed	<1000	60	60	60	0.7

ADVICE | The values marked in turquoise are side applications!
 All fz/a values in the table for material group 1.1, consider factors for the other groups!
 The specified values represent starting values.
 Depending on the material, it may be necessary to change the Vc or Fz value.
 For material groups M2.2 and M3.1, the use of cooling lubricant is recommended!

Material M 1.1

D1 ø	Roughing			Semi Finishing			Finishing		
	fz (mm/Z)	ae 0.3xD (mm)	ap 0.3xD (mm)	fz (mm/Z)	ae 0.1xD (mm)	ap 0.1xD (mm)	fz (mm/Z)	ae 0.05xD (mm)	ap 0.05xD (mm)
3	0.029	0.9	0.9	0.052	0.3	0.3	0.045	0.15	0.15
4	0.036	1.2	1.2	0.063	0.4	0.4	0.055	0.2	0.2
5	0.039	1.5	1.5	0.069	0.5	0.5	0.06	0.25	0.25
6	0.046	1.8	1.8	0.081	0.6	0.6	0.07	0.3	0.3
8	0.059	2.4	2.4	0.104	0.8	0.8	0.09	0.4	0.4
10	0.065	3	3	0.115	1	1	0.1	0.5	0.5
12	0.072	3.6	3.6	0.127	1.2	1.2	0.11	0.6	0.6
16	0.085	4.8	4.8	0.150	1.6	1.6	0.13	0.8	0.8

Cooling	
Tolerance	f8
Coating	AlphaNox Navy X

Strategy	HSC	
Application		
Features	HA 1xD R	

- Adjusted wedge angle and helical pitch for smooth running and a soft cut
- Reinforced face geometry with a special finishing level for maximum performance and surface quality

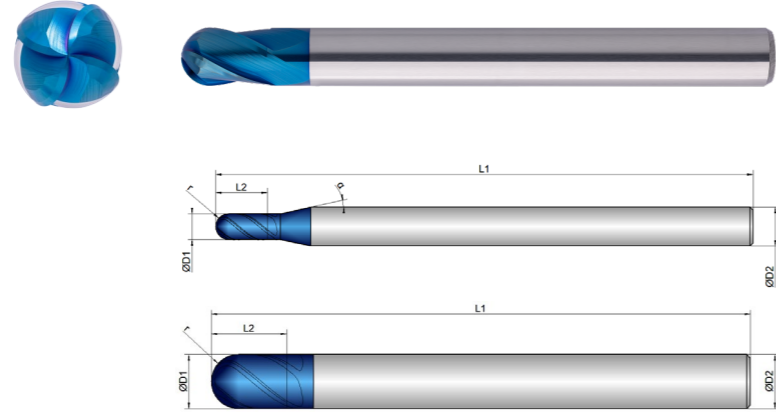

- For use in HSC milling
- For roughing and finishing
- Long version for deeper cavities

- Highest machining performance due to four cutting edges
- Radius tolerance $r \leq 2$ mm: ± 0.003 mm
- Radius tolerance $r > 2$ mm: ± 0.005 mm

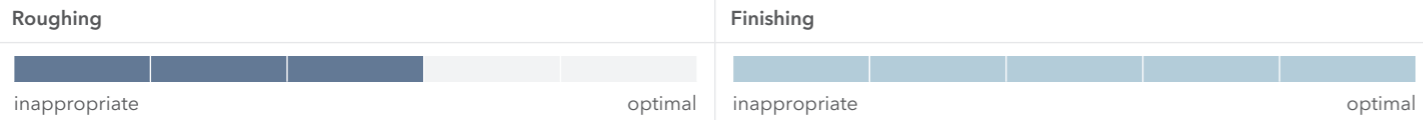

EXM1-M08-0223	D1	L2	L1	D2	z	r		β
	mm \varnothing	mm	mm	mm \varnothing	#	mm		
3	3.0	5.0	83.0	6.0	4	1.50	40	12
4	4.0	8.0	83.0	6.0	4	2.00	40	12
5	5.0	9.0	83.0	6.0	4	2.50	40	12
6	6.0	10.0	83.0	6.0	4	3.00	40	0
8	8.0	12.0	100.0	8.0	4	4.00	40	0
10	10.0	14.0	100.0	10.0	4	5.00	40	0
12	12.0	16.0	100.0	12.0	4	6.00	40	0
16	16.0	22.0	125.0	16.0	4	8.00	40	0



Download Catalog Pages (PDF)

Material	Strength (N/mm ²)	Roughing	Semi Finishing	Finishing	Materialgroup Factor fz
		Vc = m/min	Vc = m/min	Vc = m/min	
M STAINLESS STEEL					
1.1 ferritic/martensitic	<850	130	130	130	1
2.1 austenitic	<650	110	110	110	0.95
2.2 austenitic	<750	90	90	90	0.9
3.1 DUPLEX STEEL super austenitic	<1100	70	70	70	0.85
P STEEL					
1.1-1.5 unalloyed	<1100	210	210	210	1
2.1-2.4 low alloyed	<1300	160	160	160	0.9
3.1-3.3 high alloyed	<1400	155	155	155	0.8
K CASTINGS					
1.1 grey cast iron	<1000	240	240	240	0.9
T TITANIUM					
2.1-2.3 pure/alloyed	<1000	55	55	55	0.7

ADVICE | The values marked in turquoise are side applications!
 All fz/a values in the table for material group 1.1, consider factors for the other groups!
 The specified values represent starting values.
 Depending on the material, it may be necessary to change the Vc or Fz value.
 For material groups M2.2 and M3.1, the use of cooling lubricant is recommended!

Material M 1.1

D1 \varnothing	Roughing			Semi Finishing			Finishing		
	fz (mm/Z)	ae 0.3xD (mm)	ap 0.3xD (mm)	fz (mm/Z)	ae 0.1xD (mm)	ap 0.1xD (mm)	fz (mm/Z)	ae 0.05xD (mm)	ap 0.05xD (mm)
3	0.029	0.9	0.9	0.052	0.3	0.3	0.045	0.15	0.15
4	0.036	1.2	1.2	0.063	0.4	0.4	0.055	0.2	0.2
5	0.039	1.5	1.5	0.069	0.5	0.5	0.06	0.25	0.25
6	0.046	1.8	1.8	0.081	0.6	0.6	0.07	0.3	0.3
8	0.059	2.4	2.4	0.104	0.8	0.8	0.09	0.4	0.4
10	0.065	3	3	0.115	1	1	0.1	0.5	0.5
12	0.072	3.6	3.6	0.127	1.2	1.2	0.11	0.6	0.6
16	0.085	4.8	4.8	0.150	1.6	1.6	0.13	0.8	0.8

Cooling	
Tolerance	f8
Coating	AlphaNox Navy X

Strategy	HSC	
Application		
Features	HA	

- 4 specially relief-ground cutting edges for efficient 5-axis machining of demanding work pieces
- Perfectly suited for for- and backward deburring with high surface quality requirements
- Thanks to the 280° cutting edge, the entire ball can be used and the tool is designed for undercut machining

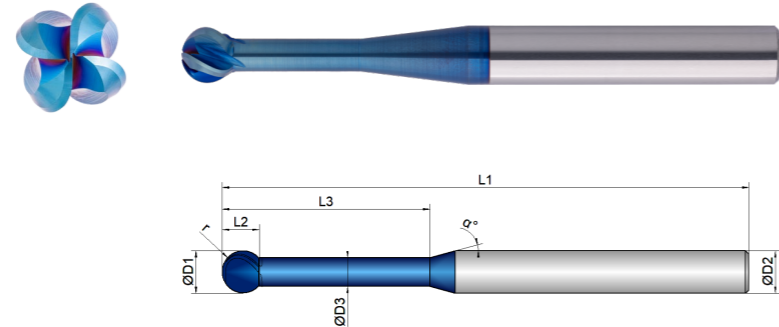

Roughing					Finishing				
inappropriate					optimal				

EXM1-M26-0123	D1 mm Ø	D3 mm Ø	L3 mm	L1 mm	D2 mm Ø	z #	r mm		α °
0,8	0.8	0.4	6.0	60.0	4.0	4	0.40	30	15
1,3	1.3	0.7	8.0	60.0	4.0	4	0.65	30	15
1,5	1.5	0.8	9.0	60.0	4.0	4	0.75	30	15
1,8	1.8	0.9	10.0	60.0	4.0	4	0.90	30	15
2,3	2.3	1.2	13.0	70.0	6.0	4	1.15	30	15
2,5	2.5	1.3	14.0	70.0	6.0	4	1.25	30	15
2,8	2.8	1.4	15.0	70.0	6.0	4	1.40	30	15
3,3	3.3	1.6	18.0	70.0	6.0	4	1.65	30	15
3,8	3.8	1.9	20.0	70.0	6.0	4	1.90	30	15
4,8	4.8	2.4	25.0	70.0	6.0	4	2.40	30	15
5,8	5.8	2.9	30.0	70.0	6.0	4	2.90	30	15
7,8	7.8	3.9	40.0	100.0	8.0	4	3.90	30	15
8,8	8.8	4.5	40.0	110.0	10.0	4	4.50	30	15
9,8	9.8	4.9	50.0	110.0	10.0	4	4.90	30	15



Download Catalog Pages (PDF)

Material	Strength (N/mm ²)	Multipass Milling	Deburring	Materialgroup Factor fz
		Vc = m/min	Vc = m/min	
M STAINLESS STEEL				
1.1 ferritic/martensitic	<850	105	50	1
2.1 austenitic	<650	85	40	0.95
2.2 austenitic	<750	80	35	0.9
3.1 DUPLEX STEEL super austenitic	<1100	70	30	0.85
P STEEL				
1.1-1.5 unalloyed	<1100	280	110	1
2.1-2.4 low alloyed	<1300	240	90	0.9
3.1-3.3 high alloyed	<1400	220	65	0.8
K CASTINGS				
1.1 grey cast iron	<1000	300	80	0.9
T TITANIUM				
2.1-2.3 pure/alloyed	<1000	45	35	0.7

ADVICE | The values marked in turquoise are side applications!
 All fz/a values in the table for material group 1.1, consider factors for the other groups!
 The specified values represent starting values.
 Depending on the material, it may be necessary to change the Vc or Fz value.
 For material groups M2.2 and M3.1, the use of cooling lubricant is recommended!

Material M 1.1

D1 Ø	Multipass Milling			Deburring		
	fz (mm/Z)	ae = 0.1xD (mm)	ap = 0.1xD (mm)	fz (mm/Z)	ae = 0.1xD (mm)	ap = 0.1xD (mm)
0.8	0.018	0.08	0.08	0.01	0.08	0.08
1.3	0.028	0.13	0.13	0.012	0.13	0.13
1.5	0.034	0.15	0.15	0.012	0.15	0.15
1.8	0.042	0.18	0.18	0.015	0.18	0.18
2.3	0.045	0.23	0.23	0.015	0.23	0.23
2.5	0.05	0.25	0.25	0.018	0.25	0.25
2.8	0.052	0.28	0.28	0.018	0.28	0.28
3.3	0.058	0.33	0.33	0.02	0.33	0.33
3.8	0.065	0.38	0.38	0.02	0.38	0.38
4.8	0.07	0.48	0.48	0.025	0.48	0.48
5.8	0.085	0.58	0.58	0.03	0.58	0.58
7.8	0.115	0.78	0.78	0.035	0.78	0.78
8.8	0.125	0.88	0.88	0.035	0.88	0.88
9.8	0.13	0.98	0.98	0.04	0.98	0.98

EXPLANATION

APPLICATIONS

Multipass milling	Trimming	Deburring	Engraving
Corner rounding	Full slot milling	Forward and backward deburring	

COOLINGS

Air-cooling	Dry machining	Oil cooling	Cooling Lubricant
Minimum quantity lubrication			

FEATURES

0,5xD	1xD	1,5xD	2xD
2,5xD	3xD	3,5xD	4xD
5xD	Center cutting	Non-center cutting	Without Weldon
With Weldon	Internal cooling	Dynamic helical pitch	Chip breaker
Unequal tooth pitch	Roughing teeth	Helical immersion	Feed directions x,y
Feed directions x, y, z	Feed directions x, y, (z)	Corner radius	Corner bevel
Sharp edged			

STRATEGY

Extended Trochoidal Cutting	High Performance Cutting	High Speed Cutting	Multi Task Cutting
Universal Machining			

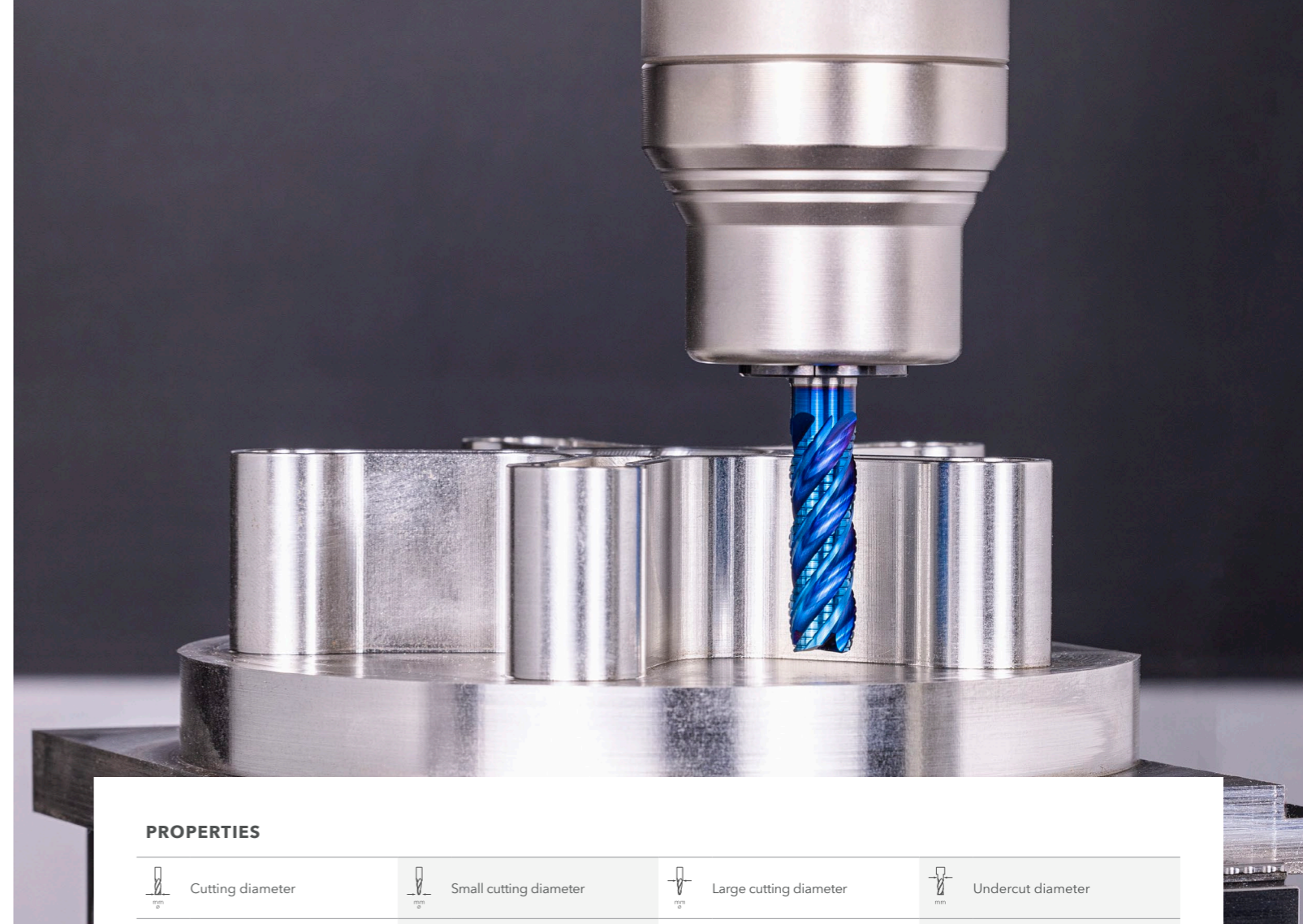

PROPERTIES

Cutting diameter	Small cutting diameter	Large cutting diameter	Undercut diameter
Cutting length	Total bevel length	Undercut length	Total length
Shank diameter	Number of teeth	Corner radius	Corner bevel
Programming radius	Maximum cutting depth	Helical angle	Alpha angle

APPLICATION TABLE

The values given in the application table are only guidelines. These values are largely dependent on the machining situation and application.

FIGURES

All technical drawings and photographs are given as an example. The product may deviate from the original in terms of colour and dimensions.

M 1.1 STAINLESS STEEL | ferritic/martensitic <850 N/mm²

Materialnumber	Germany DIN	Europe EN	France AFNOR	Great Britain BS	Italy UNI	Sweden SIS	Spain UNE	Japan JIS	USA AISI
1.4000	X6Cr13	X 6 Cr 13	Z 6 C 13	403 S 17	X 6 Cr 13	2301	X 6 Cr 13	SUS 403	403
1.4002	X6CrAl13	X 6 CrAl 13	Z 6 CA 13	405 S 17	X 6 CrAl 13	2302	X 6 CrAl 13	SUS 405	405
1.4003	X2CrNi12	X2CrNi12	CLC 4003		F 12N				
1.4005	X12CrS13	X 12 CrS 13	Z 12 CF 13	416 S 21	X 12 CrS 13	2380	X12 CrS 13	SUS 416	416
1.4006	X10Cr13	X 12 Cr 13 KD	Z 12 C 13	410 S 21	X 12 Cr 13	2302	X 12 Cr 13	SUS 410	410
1.4008	GX8CrNi13	GX 7 CrNiMo 12 1	Z 12 CN 13 M	410 C 21	GX 12 Cr 13			SCS 1	414
1.4016	X6Cr17	X 8 Cr 17	Z 8 C 17	430 S 15	X 8 Cr 17 KD	2320	X 8 Cr 17	SUS 430	430
1.4017	X6CrNi171	X 6 CrNi 17 1	F 17 N		X 6 CrNi 17 1				
1.4021	X20Cr13	X 20 Cr 13	Z 20 C 13	420 S 37	X 20 Cr 13	2303	X 20 Cr 13	SUS 420 J1	420
1.4024	X15Cr13	X 15 Cr 13	Z 12 C 13 M	420 S 29	X 12 Cr 13			SUS 410 J1	
1.4027	GX20Cr14		Z 20 C 13 M	420 C 29				SCS 2	
1.4028	X30Cr13	X 30 Cr 13	Z 30 Cr 13	420 S 45	X 30 Cr 13	2304	X 30 Cr 13	SUS 420 J2	420
1.4031	X40Cr13	X 40 Cr 13	Z 40 C 14		X 40 Cr 14	2304	X 40 Cr 13	SUS 420	420
1.4034	X45Cr13	X 45 Cr 13	Z 40 C 14	420 S 45	X 40 Cr 14		X 46 Cr 13		420
1.4057	X19CrNi172	X 19 CrNi 17 2	Z 15 CN 16.02	431 S 29	X 16 CrNi 16	2321	X 15 CrNi 16	SUS 431	431
1.4059	GX22CrNi17		Z 20 CN 17.2 M	ANC 2					
1.4085	GX70Cr29								
1.4086	GX120Cr29			425 C 11					
1.4104	X12CrMoS17	X 14 CrMoS 17	Z 10 CF 17	441 S 29	X 10 CrS 17	2383	X 10 CrS 17	SUS 430 F	430 F
1.4105	X4CrMoS18	X 6 CrMoS 17	Z 6 CDF 18-02					SUS 430 F	430
1.4106	X10CrMo13								
1.4107	GX8CrNi12	GX 8 CrNi 12	GX 8 CrNi 12		GX 8 CrNi 12				
1.4108	X100CrMo13								
1.4109	X65CrMo14	X 70 CrMo 15	Z 70 CD 14					SUS 440 A	440 A
1.4110	X55CrMo14		Z 50 CD 13						
1.4111	X110CrMoV15		Z 4 CN b 17		X 6 CrNb 17			SUS 430 LX	
1.4112	X90CrMoV18	X 90 CrMoV 18	Z 3 CT 1 2	409 S 1 9	X 6 Cr Ti 1 2			SUS 440 B	440 B
1.4113	X6CrMo171	X 8 CrMo 17	Z 8 CD 17.02	434 S 17	X 8 CrMo 17	2325		SUS 434	434
1.4115	X20CrMo171								
1.4116	X45CrMoV15	X 50 CrMoV 15	Z 50 CD 15		X50 CrMoV 15		X 46 CrMo 16		
1.4117	X38CrMoV15								
1.4119	X15CrMo13								
1.4120	X20CrMo13		Z 20 CD 14						
1.4122	X35CrMo17	X 39 CrMo 17 1	X39CrMo17-1		X 35 CrMo 17				
1.4123	X15TN								
1.4125	X105CrMo17	X 105 CrMo 17	Z 100 CD 17		X 105 CrMo 17			SUS 440 C	440 C
1.4136	GX70CrMo292		Z 60 CD 29.2 M						
1.4138	GX120CrMo292								
1.4313	X5CrNi134	X 3 CrNiMo 13 4	Z 4 CDN 13.4	425 C 11	X 3 CrNiMo 13 4	2385		SCS 5	CA 6-NM
1.4317	GX4CrNi134	GX 4 CrNi 13 4	GX 4 CrNi 13 4		GX 4 CrNi 13 4				
1.4351	X3CrNi134	X 3 CrNi 14 04 KE							
1.4405	GX5CrNiMo165	GX 4 CrNiMo 16 5 1	GX 4 CrNiMo 16 5 1		GX 4 CrNiMo 16 5 1				
1.4502	X8CrTi18	X 6 Cr 18 KE							
1.4510	X6CrTi17	X 8 CrTi 17	Z 8 CT 17		X 6 CrTi 17		X 8 CrTi 17	SUS 430 LX	430 Ti
1.4511	X6CrNb17	X 3 CrNb 17	Z 8 CNb 17		X 6 CrNb 17			SUS 430 LX	430 Nb
1.4512	X6CrTi12	X 5 CrTi 12	Z 6 CT 12	409 S 19	X 6 CrTi12			SUH 409	409
1.4523	X8CrMoTi17	X 2 CrMoTiS 18 2	X 2 CrMoTiS 18 2						
1.4528	X105CrCoMo182								
1.4535	X90CrCoMoV17								
1.4543	X3CrNiCuTi129				X 6 CrNiNb 18 11				
1.4704	X45SiCr4	45SiCr16-11							HNV 2
1.4710	GX30CrSi6	GX 30 CrSi 6							
1.4712	X10CrSi6		K 51255						
1.4713	X10CrAlSi7	X 10 CrAlSi 7							
1.4718	X45CrSi93	X 45 CrSi 8	Z 45 CS 9	401 S 45	X 45 CrSi 8		F.3220	SUH 1	HNV 3
1.4722	X10CrSi13						X 10 CrSi 13		
1.4724	X10CrAl13	X 10 CrAl 13	Z 10 C 13	BH 12	X 10 CrAl 12		X 10 CrAl 13	SUS 405	H-12
1.4725	X8CrAl144	CrAl 14 4	K 91670						
1.4729	GX40CrSi13				GX 35 Cr 13			SCH 1	
1.4740	GX40CrSi17				GX 35 Cr 17				
1.4742	X10CrAl18		Z 10 CAS 18	403 S 15	X 8 Cr 17		X 10 CrAl 18	SUH 21	430
1.4745	GX40CrSi23								
1.4747	X80CrNiSi20	X 80 CrNiSi 20	Z 80 CSN 20.02	433 S 65	X 80 CrSiNi 20		X 80 CrSiNi20-02	SUH 4	HNV 6
1.4762	X10CrAl24	X 10 CrAl 24	Z 10 CAS 24		X 16 Cr 26	2322	X 10 CrAl 24	SUH 442	446
1.4767	X8CrAl205	CrAl 20 5							
1.4773	X8Cr30								
1.4776	GX40CrSi29			452 C 11	GX 35 Cr 28			SCH 2	

M 2.1 STAINLESS STEEL | austenitic <650 N/mm²

Materialnumber	Germany DIN	Europe EN	France AFNOR	Great Britain BS	Italy UNI	Sweden SIS	Spain UNE	Japan JIS	USA AISI
1.4300	X12CrNi188					302			
1.4301	X5CrNi1810	X 6 CrNi 18 10 KD	Z 6 CN 18.09	304 S 15	X 5 CrNi 18 10	2332	X 5 CrNi 18 11	SUS 304	304 H
1.4302	X5CrNi199	X 6 CrNi 20 10 KE		308 S 96					
1.4303	X5CrNi1812	X 8 CrNi 18 12 KD	Z 8 CN 17.07	305 S 19	X 8 CrNi 19 10		X 8 CrNi 18 12	SUS 305	308
1.4305	X10CrNiS189	X 8 CrNiS 19 9	Z 8 CNF 18.09	303 S 31	X 8 CrNiS 18 9	2346	F.310.C	SUS 303	303
1.4307	X2CrNi189	X 2 CrNi 18 9	CLC 18.9.L	304 S 11	X 2 CrNi 18 9			SUS 304 L	304 L
1.4308	GX6CrNi189	X 2 CrNi 18 7	Z 6 CN 18.10 M	304 C 15	GX 5 CrNi 19 10	2333		SCS 13	CF-8
1.4310	X12CrNi177	X 12 CrNi 17 7	Z 12 CN 17.07	301 S 21	X 12 CrNi 17 07		X 12 CrNi 17 07	SUS 301	301
1.4311	X2CrNi1810	X 2 CrNiN 18 10	Z 8 CN 18.12	304 S 62	X 8 CrNi 19 10	2371	X 8 CrNi 18 12	SUS 304 LN	304 LN
1.4312	GX10CrNi188		Z 10 CN 18.9 M	302 C 25				SCS 12	
1.4318	X 2 CrNiN 18 7	X 2 CrNiN 18 7	18-7L		18-7L				
1.4319	X3CrNi178			302 S 26	X 10 CrNi 18 09			SUS 302	
1.4350	X5CrNi189		Z 6 CN 18.09	304 S 31	X 5 CrNi 18 10				304
1.4401	X5CrNiMo17122	X 6 CrNiMo 17 12 2 KD	Z 6 CND 17.11	316 S 16	X 5 CrNiMo 17 12	2347	X 5 CrNiMo 17 12	SUS 316	316
1.4404	X2CrNiMo17132	GX 3 CrNiMo 17 12 2 KD	Z 3 CND 19.10 M	316 S 12	GX 2 CrNiMo 19 11	2348	X 2 CrNiMo	SUS 316 L	316 L
1.4406	X2CrNiMoN17122	X 3 CrNiMoN 17 12 2	Z 2 CND 17.12 Az	316 S 61	X 2 CrNiMoN 17 12			SUS 316 LN	316 LN
1.4407	GX 5 CrNiMo 13 4	GX 5 CrNiMo 13 4	J 91550						A757
1.4408	GX6CrNiMo1810	GX 5 CrNiMo 19 11 2	GX 5 CrNiMo 19 11 2 316 C 16		GX 5 CrNiMo 19 11 2	2343	X 7 CrNiMo 20 10	SCS 14	CF-8M
1.4435	X2CrNiMo18143	X 2 CrNiMo 18 16	Z 2 CDN 17.13	316 S 11	X 2 CrNiMo 17 13	2353		SVS 16	316 L
1.4436	X5CrNiMo17133	X 6 CrNiMo 18 13 3 KD	Z 6 CND 17.12	316 S 16	X 5 CrNiMo 17 13	2343	X 6 CrNiMo 17 12 03	SUS 316	316
1.4438	X2CrNiMo18164	X 3 CrNiMo 18 16 4	Z 2 CND 19.15	317 S 12	X 2 CrNiMo 18 15	2367		SUS 317 L	317 L
1.4440	X2CrNiMo18165								
1.4442	X2CrNiMo18154		X 3 CrNiMoN 18 14						

M 2.2 STAINLESS STEEL | austenitic <750 N/mm²

Materialnumber	Germany DIN	Europe EN	France AFNOR	Great Britain BS	Italy UNI	Sweden SIS	Spain UNE	Japan JIS	USA AISI
1.4429	X2CrNiMoN17133	X 3 CrNiMoN 17 12 2	Z 2 CND 17.13 Az	316 S 62	X 2 CrNiMoN 17 13	2375		SUS 316 LN	316 LN
1.4432	X2CrNiMo17123	X 2 CrNiMo 17 12 2	Z 3 CND 17 13 30	316 S 13	X 2 CrNiMo 17 12 3			SUS 316L	316 L
1.4434	X2CrNiMoN18124		CLC 18.12.4.LN		X 2 CrNiMoN 18 12 4				317 LN
1.4439	X2CrNiMoN17135	X 3 CrNiMo 17 13 5	Z 3 CnD 18.14-05 Az						
1.4465	X1CrNiMoN25252								
1.4505	X5NiCrMoCuNb2018								
1.4506	X5NiCrMoCuTi2018								
1.4529	X1NiCrMoCuN25206								
1.4536	GX2NiCrMoCuN2520	GX 2 CrNiMoCuN 25 20 6							
1.4539	X1NiCrMoCuN25205	X 1 NiCrMoCu 25 20 5	Z 1 NCDU 25.20	904 S 13		2662			
1.4541	X6CrNiTi1810	X 6 CrNiTi 18 10	Z 6 CNT 18.10	321 S 12	X 6 CrNiTi 18 11	2337	X 7 CrNiTi 18 11	SUS 321	321
1.4542	X5CrNiCuNb164	X 5 CrNiCuNb 16 4	Z 7 CNU 17.04		X 5 CrNiCuNb 16 4			SUS 630	630
1.4550	X6CrNiNb1810	X 6 CrNiNb 18 10	Z 6 CENNb 18.10	347 S 17	X 6 CrNiNb 18 11	2338	X 6 CrNiNb 18 11	SUS 347	347
1.4551	X5CrNiNb199	X 5 CrNiNb 20 10 KE	Z 6 CENNb 20-10					SUS 347 Y	
1.4552	GX5CrNiNb189	GX 5 CrNiNb 19 11	Z 4 CENNb 19.10 M	347 C 17	GX 5 CrNiNb 19 11			SCS 21	
1.4571	X6CrNiMoTi17122	X 6 CrNiMoTi 17 12 2	Z 6 CNDT 17.12	320 S 31	X 6 CrNiMoTi 17 12	2350	X 6 CrNiMoTi 17 12 03	SUS 316 Ti	316 Ti
1.4573	X10CrNiMoTi812			320 S 33	X 6 CrNiMoTi 17 13			SUS 316 Ti	316 Ti
1.4575	X2CrNiMoNb2842								
1.4577	X3CrNiMoTi2525								
1.4580	X6CrNiMoNb17122	X 6 CrNiMoNb 17 12 2	Z 6 CNDNb 17.12	318 S 17	X 6 CrNiMo 17 12 2				316 Cb
1.4581	GX5CrNiMoNb1810	GX 5 CrNiMoNb 19 11 2	Z 4 CNDNb 18.12 M	318 C 17	GX 6 CrNiMoNb 20 11			SCS 22	
1.4582	X4CrNiMoNb257							SCS 22	
1.4583	X10CrNiMoNb1812				X 6 CrNiMoNb 17 13				318
1.4585	GX7CrNiMoNb257								
1.4586	X5CrNiMoCuNb2218								
1.4821	X20CrNiSi254	X 20 CrNiSi 25 4	Z 20 CNS 25.04			2322			
1.4822	GX40CrNi245		J 92605	J 92605					
1.4823	GX40CrNiSi274								
1.4825	GX25CrNiSi189			302 C 35	GX 16 CrNi 20 10				
1.4826	GX40CrNiSi229							SCH 12	
1.4828	X15CrNiSi2012	X 15 CrNiSi 20 12	Z 15 CNS 20.12	309 S 24	X 16 CrNiSi 20 12		X 15 CrNiSi 20 12	SUH 309	309
1.4833	X7CrNi2314	X 12 CrNi 23 13	Z 15 CN 24.13	309 S 24	X 6 Cni 23 14			SUS 309 S	309 S
1.4837	GX40CrNiSi2512			309 C 30	GX 35 CrNi 25 12			SCS 17	
1.4841	X15CrNiSi2520	X 15 CrNiSi 25 20	Z 15 CNS 25.20	314 S 25	X 16 CrNiSi 25 20		X 15 CrNiSi 25 20	SUH 310	310
1.4845	X12CrNi2521	X 8 CrNi 25 21	Z 12 CN 25.20	310 S 24	X 6 CrNi 25 20	2361	F.331	SUS 310 S	310 S
1.4848	GX40CrNiSi2520			310 C 40	GX 40 CrNi 26 20		X 40 CrNi 25 20	SCH 21	HK

M 2.2 STAINLESS STEEL | austenitic <750 N/mm²

Materialnumber	Germany DIN	Europe EN	France AFNOR	Great Britain BS	Italy UNI	Sweden SIS	Spain UNE	Japan JIS	USA AISI
1.4866	X33CrNiMnN238	X 33 CrNiMnN 23 8	X 33 CrNiMnN 23 8						
1.4871	X53CrMnNiN219		Z 52 CMN 21.09	349 S 54	X 53 CrMnNiN 21 9		X 53 CrMnNiN 21-09	SUH 35	EV 8
1.4873	X45CrNiW189	X 45 CrNiW 18 9	Z 35 CNWS 14.14	331 S 40	X 45 CrNiW 18 9		X 45 CrNiSiW 18-09	SUH 31	
1.4878	X12CrNiTi189	X 10 CrNiTi 18 10	Z 6 CNT 18.12	321 S 20	X 6 CrNiTi 18.11	2337	X 6 CrNiTi 18 11	SUS 321	321
1.4881	X70CrMnNiN216				X 70 CrMnNiN 21 6				EV 11
1.4882	X50CrMnNiNbN219	X 50 CrMnNiNbN 21 9	Z 50 CMNNb 21.09						
1.4919	X6CrNiMo1713	X 6 CrNiMo 17 12 2	Z 6 CND 17.13 B	316 S 51					316 H
1.4948	X6CrNi1811	X 6 CrNi 18 10	Z 6 CN 18.09	304 S 51	X 5 CrNi 18 10 KW	2333			
1.4949	X3CrNi1811				X 2 CrNiN 18 11				
1.4961	X8CrNiNb1613			347 S 51			X 7 CrNiNb 16 13		
1.4981	X8CrNiMoNb1616						X 7 CrNiMo 16 16		

M 3.1 DUPLEX STEEL | super austenitic <1100 N/mm²

Materialnumber	Germany DIN	Europe EN	France AFNOR	Great Britain BS	Italy UNI	Sweden SIS	Spain UNE	Japan JIS	USA AISI
1.4162	X2CrMnNiN2252	X 2 CrMnNiN 22 5 2			X2CrMnNiN21-5-1		S32101	LDX 2101	S321 01
1.4362	X2CrNiN234	X 2 CrNiN 23 4	Z 3 CN 23 04 AZ			2327			S323 04
1.4410	X2CrNiMoN2574	X 2 CrNiMoN 25 7 4	Z 5 CND 20.10 M		X 2 CrNiMoN 25 7 4			SCS 14 A	S327 50
1.4460	X4CrNiMo2752	X 3 CrNiMo 27 5 2	X 2 CrNiMo 25 7 3		X 3 CrNiMo 27 5 2	2324	X 8 CrNiMo 27 05	SUS 329 J1	S325 50
1.4462	X2CrNiMoN2253	X 2 CrNiMoN 22 5 3	Z 3 CND 22.05 AZ	318 S 13	X 2 CrNiMoN 22 5 3	2377		SUS 329 J3L	S318 03
1.4465	X1CrNiMoN25252	X 1 CrNiMoN 25 25 2	Z 1 CND 25.22 AZ						S310 50
1.4501	X2CrNiMoCuWN2574	X 2 CrNiMoCuWN 25 7 4	Z 3 CND 25.06 AZ					SM 25 Cr	S327 60
1.4507	X2CrNiMoCuN2563	X 2 CrNiMoCuN 25 6 3	Z 3 CNDU 25.06 AZ					OSA 2505	S325 20
1.4534	13-8 PH	X 3 CrNiMoAl 13 8 2	Z 4 CNDAT 13.09						S138 00
1.4542	17-4 PH	X 5 CrNiCuNb 16 4	Z 7 CNU 17 04					SUS 630	630
1.4545	15-5 PH	X 5 CrNiCu 15 5	Z 6 CNU 15 05						XM-12
1.4548	17-4 PH	X5CrNiCuNb1744	X 5 CrNiCuNb 16 4					SUS 630	S174 00
1.4568	17-7 PH	X 7 CrNiAl 17 7	Z 9 CNA 17 07	301 S 81	X 7 CrNiAl 17 7	2388	X 7 CrNiAl 17 7	SUS 631	S177 00

P 1.1 STEEL | unalloyed <500 N/mm²

Materialnumber	Germany DIN	Europe EN	France AFNOR	Great Britain BS	Italy UNI	Sweden SIS	Spain UNE	Japan JIS	USA AISI
1.0498	ST42.8							STPT 42	
1.0044	ST442		E28-2	4360-43 B	Fe 430 BFN	1412	AE 275-B	SM 41 B	570 Gr. 40
1.0420	GS38	GE 200	230-400M			1306			
1.0446	GS45	GE 230	E23-45M	A1		1305	F.221	SC 450	
1.0136	St42-3								
1.0254	St37.0	P235T1						STPG 38	
1.1120	GS20Mn5							SMnC 420	
1.1121	Ck10	2 C 10	XC 10	040 A 10	C 10	1265	C 10 k	S 10 C	1010
1.1131	GS15Mn5								
1.1151	Ck22	2 C 22	XC 25	050 A 20	C 20		C 25 k	S 22 C	1023
1.5523	19MnB4			170 H 20			20 Mn B 4 DF	SWRCHB	
1.8961	WTS1373				Fe 360 D FF			SMA 50 A	
1.0035	ST33		A 33		FE 320			SS 330	
1.0037	ST37-2							STKR 400	
1.0710	15S10								
1.0715	9SMn28	11 SMn 28	S 250	230 M 07	CF 9 SMn 28	1912	11 SMn 28	SUM 22	1213
1.0718	9SMnPb28	11 SMnPb28	S 250 Pb		CF 9SMnPb 28	1914	11 SMnPb 28	SUM 22 L	12 L 13
1.0721	10S20	10 S 20	10 F 1	210 M 15	CF 10 S 20		10 S 20		1108
1.0722	10SPb20	10 SPb 20	10 Pb F 2		CF 10 SPb 20		10 SPb 20		11 L 08
1.0736	9SMn36		S300	240 M 07	CF 9 SMn 36		12 SMn 35	SUM 25	1215
1.0737	9SMnPb36		S 300 Pb		CF 9 SMnPb 36	1926	12 SMnPb 35		12 L 14

P 1.2 STEEL | unalloyed <700 N/mm²

Materialnumber	Germany DIN	Europe EN	France AFNOR	Great Britain BS	Italy UNI	Sweden SIS	Spain UNE	Japan JIS	USA AISI
1.0553	S244J0	S355J0	E 36-3	En 50 C	Fe 510 C FN			SM 520 M	S355J0
1.0581	ST52.4							STS 49	
1.1140	C15R	C15R	C15R	C15R					
1.1141	Ck15	2 C 15	XC 15	080 M 15	C 15	1370	C 16 k-1		
1.1190	S355G15								
1.0116	ST373		E 24-3	4360-40 C	Fe 37-3	1312	A 360 C		A 570 Gr. 36
1.0144	ST443		E 28-3	4360-43 C	Fe 430 D FF	1414	AE 275-D	SM 41 B	A 573 Gr. 70
1.0401	C15		CC12	080 M 15	C 15	1350	F.111	S 15 C	1015
1.0402	C22	1 C 22	CC 22	070 M 20	C 22		C 22 k	SFVC 1	
1.0406	C25	1 C 25	CC 25	070 M 26	C 25		C 25 k	S 22 C	1025
1.0461	STE255								
1.0482	19Mn5		A 52 CP	224-460				SG 37	
1.0486	STE285				FE E 285 KG		AE 285 KG	SM 41 A	
1.0501	C35	1 C 35	CC 35	060 A 35	C 35	1550	F.113	S 35 C	1035
1.0503	C45	1 C 45	CC 45	080 M 46	C 45	1650	C 45 k	S 45 C	1045
1.0505	STE315							SM 50 A	
1.0511	C40	1 C 40		080 M 40			F.114.A	S 40 C	1040
1.0528	C30	1 C 30	CC 32	080 M 30	C30			SUP 7	1030
1.0540	C50	1 C 50		080 M 50		1674		S 50 C	1050
1.0552	GS52	GE 260							
1.0558	GS60	GE 300	320-560M	A3	C 45	1606			
1.0562	STE355		E 355 R/FP		Fe E 355 KG	2132	AE 355 KG	SM 50 YB	A 633 Gr. C
1.0711	9S20			220 M 07	CF 9 S 22			G 11120	1212
1.0970	38Si7		41 S 7						
1.1106	ESTE355			P 355 NL 2				STK 500	
1.1127	36Mn6			212 M 36				SMn 443	1141
1.1133	20MnS			120 M 19	G 22 Mn3		20 Mn 6	SMn 420	1022
1.1169	20Mn6								
1.1520	C70W1				C 70 KU				
1.5637	10Ni14			503	18 Ni 14 KT				A 350-LF 5
1.8962	9CrNiCuP324			WR 50 A				SPA-H	
1.0726	35S20	35 S 20	35 MF 4	212 M 36			1957	F.210G	1140
1.0760	38SMn28	38SMn28	38SMn28	38SMn28				38SMn28	
1.1158	Ck25	2 C 25	XC 25	070 M 26	C 25		C 25 k	S 25 C	1025
1.1178	Ck30	2 C 30	XC 32	080 M 30	C30			S 30 C	1030
1.1181	Ck35	2 C 35	XC 38 H1	080 M 36	C35	1572	C 35 k	S 35 C	1034
1.1183	CF35		XC 38 TS	060 A 35	C35	1572		S 35 C	1035
1.1191	Ck45	2 C 45	XC 42	080 M 46	C40		C45 k	S 45 C	1045
1.1206	Ck50	2 C 50		080 M 50	C50	1674		S 50 C	1050
1.1730	C45W	C 45 U	Y3 42						
1.5423	16Mo5			1503-245-420	16 Mo 5		16 Mo 5	SBC 690	4520

P 1.3 STEEL | unalloyed <850 N/mm²

Materialnumber	Germany DIN	Europe EN	France AFNOR	Great Britain BS	Italy UNI	Sweden SIS	Spain UNE	Japan JIS	USA AISI
1.1165	G530Mn5		35 M 5	120 M 36		1330	30 Mn 5	SMn 433 H	1330
1.1525	C80W1	C 80 U	Y1 90		C 80 KU	1880	F.513		W 108
1.1545	C105W1	C 105 U	Y1 105	BW 1A	C 100 KU	1880	F.515		W 110
1.1620	C70W2	C 70 U							
1.1625	C80W2		Y1 80	BW 1B	C 80 KU		C 80	SKC 3	W 1
1.1645	C105W2						C 102	SK 3	
1.1663	C125W	C 120 U	Y2 120		C 120 KU		C 120	SK 2	W 112
1.1673	C135W		Y2 140		C 140 KU			SK 1	
1.1740	C60W		Y3 55					SK 7	
1.1820	C55W								
1.1830	C85W	C 90 U	Y3 90					SK 5	1084
1.1744	C67W		Y1 70				F.512		A-6
1.1750	C75W			BW 1A					W 1
1.5404	21MoV53								
1.5406	17MoV84								
1.5633	24Ni8	G 9 Ni 10	22 N 8		G 9 Ni 10			SCPL 21	
1.6311	20MnMoNi45	20 MnMoNi 4 5						SQV 2 B	
1.7242	16CrMo4	18 CrMo 4	15 CD 3.5		18 CrMo 4		18 CrMo 4	SCM 418 H	
1.7258	24CrMo4							SCM 822 H	
1.7259	26CrMo7								
1.7273	24CrMo10								
1.7337	16CrMo44				A18 CrMo 4 5 KW				A 387 Gr. 12 Cl. 2
1.7350	22CrMo44								
1.7362	12CrMo195	X 12 CrMo 5	Z 10 CD 5.05	3606-625	16 CrMo 20 5			SCMV 6	
1.7709	21CrMoV57	21 CrMoV 5 7	20 CDV 5.07						
1.7766	17CrMoV10								
1.7779	20CrMoV135								

P 1.4 STEEL | unalloyed <950 N/mm²

Materialnumber	Germany DIN	Europe EN	France AFNOR	Great Britain BS	Italy UNI	Sweden SIS	Spain UNE	Japan JIS	USA AISI
1.0062	ST601								
1.0532	ST522	S 390 G 1 S							
1.0535	C55	1 C 55	C 55	070 M 55	C 55	1655		C 55	1055
1.0570	ST523	S 355 J2 F3	E 36-3	4360-50 B	Fe 510 B	2132	A 510 C	SM 50 YB	
1.0728	60S20	60 S 20	60 MF 4						1151
1.1203	Ck55	2 C 55	XC 55 H1	070 M 55	C 55	1655	C 55 k	S 55 C	1055
1.7276	10CrMo11		12 CD 10						
1.7281	16CrMo93		20 CD 8						

P 1.5 STEEL | unalloyed <1100 N/mm²

Materialnumber	Germany DIN	Europe EN	France AFNOR	Great Britain BS	Italy UNI	Sweden SIS	Spain UNE	Japan JIS	USA AISI
1.0070	ST702		A 70-2		Fe 70-2		A 690-2		
1.0601	C60	1 C 60	AF 70 C 55	080 A 62	C 60			S 60 C-CSP	1060
1.1221	Ck60	2 C 60	XC 60	060 A 62	C 60	1678		S 58 C	1060
1.1223	Cm60	3 C 60	C 60 R	080 A 67	C 60 R				
1.0603	C67W								

P 2.1 STEEL | low alloyed <750 N/mm²

Materialnumber	Germany DIN	Europe EN	France AFNOR	Great Britain BS	Italy UNI	Sweden SIS	Spain UNE	Japan JIS	USA AISI
1.0961	60SiCr7	60 SiCr 8	60 SC 7	250 A 61	60 SiCr 8		60 SiCr 8	SUP 7	9262
1.2101	62SiMnCr4								
1.2162	21MnCr5	21 MnCr 5	20 NC 5					SCR 420 H	
1.2208	31CrV3								
1.2210	115CrV3	107 CrV 3 KU	100 C 3		107 CrV 3 KU		F.520.L		L2
1.2235	80CrV2						F.520.J		
1.2241	51CrV4	51 CRMnV 4			51 CrMnV 4 KU				S6
1.2307	29CrMoV9								
1.2323	48CrMoV67		45 CDV 6						
1.2382	GX155CrVMo121								
1.2414	120W4						F.532		
1.2542	45WCrV7	45 WCrV 8		BS 1	45 WCrV 8 KU	2710	45 WCrSi 8		S1
1.2552	80WCrV8						60 WCrSi 8		
1.2726	26NiCrMoV5								
1.2737	28NiCrV5								
1.2738	40CrMnNiMoB64	40CrMnNiMoB 6-4							
1.2826	60MnSi4		60 MSC 4						
1.2838	145V33								
1.2842	90MnCrV8	90 MnV 8	90 MV 8	BO 2	90 MnVCr 8 KU				0 2
1.5752	14NiCr14	13 NiCr 12	16 NC 12	655 M 13	16 NiCr 11			SNC 815 H	E3310
1.5919	15CrNi6	14 CrNi 6	16 NC 6	S 107	16 CrNi 4			SNCM 420	
1.7003	38Cr2	38 Cr 2 KD	38 C 2	120 M 36	38 Cr 3		38 Cr 3	SMn 438	50 B40
1.7012	13Cr2								
1.7045	42Cr4	40 NiCrMo 3	42 C 4 TS	530 A 40	41 Cr 4	2245	42 Cr 4	SCR 440	5140
1.7103	67SiCr5	67 SiCr 5			67 SiCr 5				
1.7131	16MnCr5	16 MnCr 5 KD	16 MC 5	527 M 17	16 MnCr 5	2173	16 MnCr 5	SCR 415	5115
1.7271	23CrMoB33								
1.7715	14MoV63	14 MoV 6-3		1503-660-440			13 MoCrV 6		
1.8907	STE500							SM 58	
1.8911	ESTE380								

P 2.2 STEEL | low alloyed <950 N/mm²

Materialnumber	Germany DIN	Europe EN	France AFNOR	Great Britain BS	Italy UNI	Sweden SIS	Spain UNE	Japan JIS	USA AISI
1.0902	46Si7		45 S7				46 Si 7		
1.0906	65Si7			250 A 61					
1.0985	QSTE500N								
1.1157	40Mn4		35 M 5	150 M 36					1039
1.1167	36Mn5		40 M 5	150 M 36		2120	36 Mn 5		1335
1.1170	28Mn6	28 Mn 6	35 M 5	150 M 17	C 28 Mn		36 Mn 6	SCMn 1	1330
1.1199	49MnVS3			280 M 01					
1.2002	125Cr1		Y2 120 C						
1.2003	75Cr1		35 M 5	150 M 36					
1.2004	85Cr1		Y1 100 C 2						
1.2008	140Cr3		Y2 140 C					SKS 8	
1.2056	90Cr3								
1.2057	105Cr4						F.120.J	SKC 11	
1.2108	90CrSi5	P 280 GH			C 100 KU	2092		SFVC 2A	
1.2109	125CrSi5								
1.2127	105MnCr4				100 CrMn 4 KU			SUJ 3	
1.2206	140CrV1		130 C 3						0 6
1.2242	59CrV4								
1.2243	61CrSiV5								
1.2249	45SiCrV6								
1.2303	100CrMo5						F.520.F		L 7
1.2312	40CrMnMoS86		40 CMD 8						
1.2519	110WCrV5						102 WCrV 5		
1.2562	142WV13								
1.2740	28NiCrMoV10								
1.2743	60NiCrMoV124								
1.2747	28NiMo17								
1.2766	35NiCrMo16								
1.2851	34CrAl6								
1.3501	100Cr2		100 C 2						E 50100
1.3503	105Cr4								E51100
1.3505	100Cr6	100 Cr 6	100 C 6	535 A 99	100 Cr 6	2258	100 Cr 6	SUJ 2	E52100
1.3520	100CrMn6	100 Cr Mn 6	100 CM 6				100 CrMn 6		

P 2.3 STEEL | low alloyed <1100 N/mm²

Materialnumber	Germany DIN	Europe EN	France AFNOR	Great Britain BS	Italy UNI	Sweden SIS	Spain UNE	Japan JIS	USA AISI
1.2419	105WCr6	105 WCr 5	105 WC 13		107 WCr 5 KU	2140	105 WCr 5	SKS 31	
1.2511	80WCrV3								
1.2515	100WV4							SKS 21	
1.3561	44Cr2	46 Cr 1 KD	44 Cr 2						5046
1.3563	43CrMo4		43 CrMo 4						4142
1.3565	48CrMo4								
1.5023	38Si7								
1.5025	51Si7	50 Si 7			48 Si 7	2090			9259 H
1.5029	71Si7								
1.5085	51Mn7								
1.5094	38MnS6	38 MnS 6							
1.5131	50MnSi4								
1.5141	53MnSi4								
1.5142	60MnSi5								
1.5213	15MnV5								
1.5217	20MnV6								
1.5223	42MnV7								
1.5225	51MnV7								
1.5231	38MnSiV55								
1.5232	27MnSiV56								
1.5233	44MnSiV56								
1.5403	17MnMoV64			1501-261				SBV 3	
1.5526	30MnB4								
1.5710	36NiCr6		30 NC 6	640 A 35				SNC 236	3135
1.5736	36NiCr10		30 NC 11		35 NiCr 9			SNC 631 H	3435
1.5755	31NiCr14		18 NC 13	653 M 31				SNC 836	
1.6225	11NiMn54								
1.6310	20MnMoNi55		18 MND 5						
1.6368	15NiCuMoNb5			3604-591				SBV 2	
1.6511	36CrNiMo4	36 CrNiMo 4	40 NCD 3	816 M 40	38 NiCrMo 4 KB		35 NiCrMo 4		9840
1.6582	34CrNiMo6	34 CrNiMo 6	35 NCD 6	817 M 40	35 NiCrMo 6 KB	2541	40 NiCrMo 7	SNCM 447	4340
1.6946	30CrMoNiV511								
1.6948	26NiCrMoV115								
1.6971	79Ni1								
1.6972	83Ni1								
1.7038	37CrS4	37 CrS 4						SUP 11	50 B50 H
1.7214	25CrMo4				25 CrMo 4 F				
1.7389	GX12CrMo101								
1.7561	42CrV6								
1.7701	51CrMoV4		51 CDV 4		51 CrMoV 4				
1.7707	30CrMoV9								
1.7711	40CrMoV47	40 CrMoV 4 6	42 CDV 4	1506-670-860				SNB 21-1-5	
1.7725	GS30CrMoV64								
1.7733	24CrMoV55		20 CDV 6		24 CrMoV 5 5				
1.7735	14CrMoV69								
1.7741	42CrMoV73								
1.7755	GS45CrMoV104								
1.7756	GS36CrMoV104	G 36 CrMoV 10 4							
1.8070	21CrMoV511				21 CrMoV 5 11				
1.8159	50CrV4	51 CrV 4	50 CV 4	735 A 50	50 CrV 4	2230	51 CrV 4	SUP 10	6150
1.8212	21CrVMoW12								
1.8521	15CrMoV59								
1.8509	41CrAlMo7	41 CrAlMo 7	40 CAD 6. 12	905 M 39	41 CrAlMo 7	2940	41 CrAlMo 7	SACM 645	E 71400
1.8515	31CrMo12	31 CrMo 12	30 CD 12	722 M 24	31 CrMo 12	2240	31 CrMo 12		
1.8523	39CrMoV139	39 CrMoV 13 9		897 M 39	36 CrMoV 10				
1.8550	34CrAlNi7	34 CrAlMo 5							
1.8827	S460M	S 460 M	E 460	S 460 M	S460M		S460M		

P 2.4 STEEL | low alloyed <1300 N/mm²

Materialnumber	Germany DIN	Europe EN	France AFNOR	Great Britain BS	Italy UNI	Sweden SIS	Spain UNE	Japan JIS	USA AISI
1.1273	90Mn4			060 A 96				SUP 4	1090
1.2311	40CrMnMo7			BP 20	35 CrMo 8 KU				P 20
1.2710	45NiCr6								
1.2762	75CrMoNiW67								
1.5864	35NiCr18								
1.6587	17CrNiMo6	17 CrNiMo 7	18 NCD 6	820 A 16	18 NiCrMo 7	2523	14 NiCrMo 13	SNCM 815	
1.7222	42CrMoPb4								
1.7225	42CrMo4.M4S	42 CrMo 4	42 CD 4	708 A 42	42 CrMo 4	2244		SCM 440 H	4140
1.7227	42CrMoS4	42 CrMoS 4	42 CD	708 H 42	42 CrMoS 4	2244	40 CrMo 4		
1.7238	49CrMo4								

P 3.1 STEEL | high alloyed <800 N/mm²

Materialnumber	Germany DIN	Europe EN	France AFNOR	Great Britain BS	Italy UNI	Sweden SIS	Spain UNE	Japan JIS	USA AISI
1.2362	X63CrMoV51								
1.2363	X100CrMoV51	X 100 CrMoV 5 1	Z 100 CDV 5	BA 2	X 100 CrMoV 5 1 KU	2260	X 100 CrMoV 5	SKD 12	A 2
1.2367	X38CrMoV53		Z 38 CDV 5 3						
1.2376	X96CrMoV12								
1.2379	X155CrVMo121	X 153 CrMoV 12	Z 160 CDV 12	BD 2	X 155 CrVMo 12 1 KU	2310		SKD 11	D 2
1.2453	X130W5								
1.2564	X30WCrV41	30 WCrV 15 1					F.527		
1.2567	X30WCrV53	X 30 WCrV 5 3	Z 32 WCV 5		X 30 WCrV 5 3 KU			SKD 4	
1.2606	X37CrMoW51		Z 35 CWDV 5	BH 12	X 35 CrMoW 05 KU		F.537	SKD 62	H 12
1.2631	X50CrMoW911								
1.2786	X13NiCrSi3615	X 13 CrNiSi 36 15	Z 35 NCS 37-18						
1.2889	X45CoCrMoV553								

P 3.2 STEEL | high alloyed <1100 N/mm²

Materialnumber	Germany DIN	Europe EN	France AFNOR	Great Britain BS	Italy UNI	Sweden SIS	Spain UNE	Japan JIS	USA AISI
1.2083	X42Cr13	X 42 Cr 13	Z 40 C 14		X 41 Cr 13 KU	2314		SUS 420 J2	420
1.2316	X36CrMo17	X 36 CrMo 17	X38CrMo 16 1		X 38 CrMo 16 1 KU		X 38 CrMo 16		D-4
1.2343	X38CrMoVH1	X 38 CrMoV 5 1	Z 38 CDV 5	BH 11	X 37 CrMoV 5 1 KU		X 37 CrMoV 5	SKD 6	H 11
1.2344	X40CrMoV51	X 40 CrMoV 5 1	Z 40 CDV 5	BH 13	X 40 CrMoV 5 1 1 KU	2242	X 40 CrMoV 5	SKD 61	H 13
1.2436	X210CrW12	X 210 CrW 12	Z 210 CW1 2		X 215 CrW 12 1 KU	2312	X 210 CrW 12	SKD 2	
1.2581	X30WCrV93	X 30 WCrV 9 3	Z 30 WCV 9	BH 21	X 30 WCrV 9 3 KU		X 30 WCrV 9	SKD 5	H 21
1.2601	X165CrMoV12	X 165 CrMoV 12			X 165 CrMoW 12 KU	2310	X 160 CrMoV 12		
1.2622	X60WCrMoV94								
1.2678	X45CrCoW555								H 19
1.2731	X50NiCrWV1313								
1.2764	X19NiCrMo4								
1.2767	X45NiCrMo4	40 NiCrMo 4	Y 35 NCD 16		42 NiCrMo 15 7 KU				A 9
1.2779	X6NiCrTi2615				S 66286				660
1.2787	X23CrNi17	HS 6-5-2	Z 85 WDCV 06 05 04 02	BM 2	HS 6 5 2 2	2722		SKH 9	
1.3302	S1214	HS 12 1 4			X 150 WW 1305 KU				A 7
1.3318	S1212	HS 02.01.12							
1.3401	X120Mn12	X 120 Mn 12	Z 120 M 12	BW 10	X G 120 Mn 12	2183	AM-X 120 Mn 12	SCMnH 1	A 128
1.3543	X102CrMo17	X 102 CrMo 17	X100CrMo17		X 105 CrMo 17		X 100 CrMo 17		
1.3549	X89CrMoV81								
1.3551	80MoCrV4216		80 DCV 40	T 11350	X 80 MoCrV 4 4		80 MoCrV 40-16		M 50

P 3.3 STEEL | high alloyed <1400 N/mm²

Materialnumber	Germany DIN	Europe EN	France AFNOR	Great Britain BS	Italy UNI	Sweden SIS	Spain UNE	Japan JIS	USA AISI
1.2709	X3NiCoMoTi1895								
1.2790	72SiNiCrMoV54								
1.2888	X20CoCrWMo109								
1.3202	S12145	HS12-1-5-5		BT 15	HS 12-1-5-5		12-1-5-5		T 15
1.3207	S104310	HS10-4-3-10	Z130WKCDV10-10-04-04	BT 42	HS 10-4-3-10		10-4-3-10	SKH 57	M 44
1.3243	S6525	HS6-5-2-5	KCV 06-05-05-04-02		HS 6-5-2-5	2723	6-5-2-5	SKH 55	M 35
1.3246	S7425	HS1-8-1	Z110 WKCDV 07-05-04	T 11341	HS 7-4-2-5		7-4-2-5		M 41
1.3247	S21018	HS2-9-1-8	Z110 DKCWV 09-08-04	BM 42	HS 2-9-1-8		2-10-1-8		M 42
1.3249	S2928			BM 34			2-9-2-8		
1.3255	S18125	HS18-1-1-4	Z80 WKCV 18-05-04-01	BT 4	HS 18-1-1-5		18-1-1-5	SKH 3	T 4
1.3257	S181215								
1.3265	S181210	HS18-0-1-10		BT 5	HS 18-0-1-10		18-0-2-10	SKH 4A	T 5
1.3342	SC652	HS6-5-2	Z90 WDCV 06-05-04-02		HSC 6-5-3				M 3
1.3343	S652	HS6-5-3	Z85 WDCV 06-05-04-02	BM 2	HS 6-5-2	2722	6-5-2	SKH 51	M2
1.3344	S653		Z120 WDCV 06-05-04-03				6-5-3	SKH 52	M 3 Cl.2
1.3346	S291	HS1-8-1	Z85 DCWV 08-04-02-01	BM 1	HS 1-8-1				M1
1.3348	S292	HS2-9-2	Z100 DCWV 09-04-02-02		HS 2-9-2	2782	2-9-2		M 7
1.3355	S1801	HS18-0-1	Z80 WCV 18-04-01	BT 1	HS 18-0-1		18-0-1	SKH 2	T 1

K 1.1 GREY CAST IRON <600 N/mm² (180 HB)

Materialnumber	Germany DIN	Europe EN	France AFNOR	Great Britain BS	Italy UNI	Sweden SIS	Spain UNE	Japan JIS	USA AISI
0.6010	GG10	GJL-100	FGL 100	Grade 100	G 10	0110-00	FG 10	FC 100	A48-20 B
0.6012	GG150 HB	GJL-HB 170							
0.6015	GG15	GJL-150	FGL 150	Grade 150	G 15	0115-00	FG 15	FC 150	A48-25 B
0.6017	GG170 HB	GJL-HB 205							

K 1.2 GREY CAST IRON <1000 N/mm² (300 HB)

Materialnumber	Germany DIN	Europe EN	France AFNOR	Great Britain BS	Italy UNI	Sweden SIS	Spain UNE	Japan JIS	USA AISI
0.6020	GG20	GJL-200	FGL 200	Grade 220	G 20	0120-00	FG 20	FC 200	A48-30 B
0.6022	GG190 HB	GJL-HB 230							
0.6025	GG25	GJL-250	FGL 250	Grade 260	G 25	0125-00	FG 25	FC 250	A48-40 B
0.6027	GG220 HB	GJL-HB 250	FGL 250						
0.6030	GG30	GJL-300	FGL 300	Grade 300	G 30	0130-00	FG 30	FC 300	A48-45 B
0.6032	GG240 HB	GJL-HB 275							
0.6035	GG35	GJL-350	FGL 350	Grade 350	G 35	0135-00	FG 35	FC 350	A48-50 B
0.6037	GG260 HB	GJL-HB 275							
0.6040	GG40	GJL-400	FGL 400	Grade 400		0140-00			A48-60 B

K 2.1 MODULAR CAST IRON <650 N/mm² (200 HB)

Materialnumber	Germany DIN	Europe EN	France AFNOR	Great Britain BS	Italy UNI	Sweden SIS	Spain UNE	Japan JIS	USA AISI
0.7033	GGG353					0717-15			
0.7040	GGG40	GJS-400-15	FGS 400-12	FGS 420/12	GS 400-12	0717-02		FCD 400	60-40-18
0.7043	GGG403	GJS-400-18	FGS 370-17	FGS 370/17	GSO 42/15	0717-15		FCD 370	
0.7050	GGG50	GJS-500-7	FGS 500-7	FGS 500/7	GS 500/7	0727-02		FCD 500	65-45-12

K 2.2 MODULAR CAST IRON <850 N/mm² (250 HB)

Materialnumber	Germany DIN	Europe EN	France AFNOR	Great Britain BS	Italy UNI	Sweden SIS	Spain UNE	Japan JIS	USA AISI
0.7060	GGG60	GJS-600-3	FGS 600-3	SNG 600/3	GS 600/3	0732-03		FCD 600	80-55-06
0.7070	GGG70	GJS-700-2	FGS 700-2	SNG 700/2	GS 700-2	0737-01		FCD 700	100-70-03
0.7080	GGG80	GJS-800-2	FGS 800-2	SNG 800/2	GS 800-2			FCD 800	

K 3.1 MALLEABLE CAST IRON <440 N/mm² (130 HB)

Materialnumber	Germany DIN	Europe EN	France AFNOR	Great Britain BS	Italy UNI	Sweden SIS	Spain UNE	Japan JIS	USA AISI
0.8038	GTWS3818	GJMW-360-12	MB 300-12	W 38-12	W38-12	5922			
0.8040	GTW4005	GJMW-400-5	MB 400-5	W 40-05	GMB 40			FCMW 370	
0.8045	GTW4507	GJMW-450-7	MB 450-7	W 40-07	GMB 45			FCMWP 440	
0.8055	GTW55				GMB 55				
0.8065	GTW65				GMB 65				
0.8135	GTS3510	GJMB-350-10	MN 350-10	B 340/12		0815		FCMP 330	32510
0.8145	GTS4506	GJMB-450-6	MP 45-06	P 440/7		0852		FCMP 440 c3	40010

K 3.2 MALLEABLE CAST IRON <800 N/mm² (230 HB)

Materialnumber	Germany DIN	Europe EN	France AFNOR	Great Britain BS	Italy UNI	Sweden SIS	Spain UNE	Japan JIS	USA AISI
0.8035	GTW3504	GJMW-350-4						FCMW 330 c1	
0.8155	GTS5504	GJMB-550-4	MP 50-5	P 510/4		0854		FCMP 490	50005
0.8165	GTS6502	GJMB-650-2	MP 60-3	P 570/3		0858		FCMP 540	70003
0.8170	GTS7002	GJMB-700-2	Mn 700-2	P 690/2	GMN 70	0862		FCMP 690	90001

Technical formulas

Calculate cutting speed (m/min)

$$V_c = \frac{D \cdot \pi \cdot n}{1000}$$

Calculate rotational speed (rpm)

$$n = \frac{V_c \cdot 1000}{D \cdot \pi}$$

Calculate feed rate (mm/min)

$$V_f = n \cdot z \cdot f_z$$

Calculate feed per tooth (mm/number of teeth)

$$f_z = \frac{V_f}{n \cdot z}$$

Calculate chip removal rate (cm³/min)

$$Q = \frac{a_p \cdot a_e \cdot V_f}{1000}$$

Calculate average chip thickness (mm)

$$h_m = f_z \cdot \frac{\sqrt{a_e}}{D}$$

Explanation of terms

V _c	Cutting speed	in m/min
n	Rotational speed	in rpm
V _f	Feed rate	in mm/min
F _z	Feed per tooth	in mm/number of teeth
z	Number of teeth (cutting)	
a _p	Depth of cut	in mm
a _e	Width of cut	in mm
h _m	Average chip thickness	in mm
Q	Chip removal rate	in cm ³ /min
D	Diameter of tool	in mm



GENERAL TERMS OF SALE

§ 1 SCOPE

1. These General Terms of Sale apply to all business relationships between Hofmann & Vratny OHG (hereinafter referred to as “Hofmann & Vratny”) and its customers (hereinafter referred to individually as the “Ordering Party” and collectively as the “Ordering Parties”).

2. These General Terms of Sale only apply to Ordering Parties that are entrepreneurs pursuant to §§ 14 and 310 para. 1 of the BGB (Civil Code of Germany), legal entities under public law, and/or special funds under public law.

3. The scope of application of these General Terms of Sale includes, but is not limited to, contracts regarding the sale and/or delivery of chattels (hereinafter referred to as “Goods”) regardless of whether they are produced by Hofmann & Vratny or procured from suppliers (§§ 433 and 651 of the BGB). Unless agreed upon otherwise, the version of these General Terms of Sale applicable at the time the Ordering Party places an order and in any case the most recent version of these General Terms of Sale provided to the Ordering Party in writing in the form of a master agreement also shall apply to similar contracts made at a later date without Hofmann & Vratny being required to make reference to them in every individual case.

4. These General Terms of Sale shall apply exclusively. These General Terms of Sale also shall apply if and when Hofmann & Vratny executes a delivery without reservation despite having knowledge of the Ordering Party’s terms of sale which contradict or deviate from these General Terms of Sale. Any of the Ordering Party’s terms of sale which contradict or deviate from these General Terms of Sale shall become part of a contract only with Hofmann & Vratny’s express prior consent. Such requirement to consent shall apply in any case even, for example, if the Ordering Party refers to its terms of sale as part of an order placement and Hofmann & Vratny does not object explicitly to such terms.

5. If Hofmann & Vratny and the Ordering Party have entered into any individual agreements, such individual agreements shall prevail over these General Terms of Sale. The content of such individual agreements only can be substantiated by a written contract or by written confirmation from Hofmann & Vratny. Individual agreements (e.g., outline delivery contracts, quality assurance agreements) and information provided in Hofmann & Vratny’s order confirmation shall prevail over these General Terms of Sale. In case of doubt, commercial clauses shall be interpreted based on the Incoterms® issued by the International Chamber of Commerce in Paris (ICC) and applicable at the time the contract is entered into.

6. All of the Ordering Party’s legal declarations and notifications made with regard to the contract (e.g., in connection with deadlines or notices of defects, rescission, or reduction) shall be made in writing to be effective. In the context of these General Terms of Sale, in writing shall include written and text forms (e.g., letters, e-mails, faxes). Legal requirements regarding form and other verifications including, but not limited to, cases of doubt regarding the legitimation of the notifying party shall remain unaffected.

7. All references to applicable laws shall be for the purpose of clarification only. Unless amended in or excluded expressly from these General Terms of Sale, laws shall apply even without express reference.

§ 2 OFFERS AND ACCEPTANCE

1. All offers made by Hofmann & Vratny shall be subject to change and shall be non-binding including if and when images, drawings, technical documentation, calculations, analyses, other documents or product descriptions of whatever nature (hereinafter referred to as “Documents”) are provided to the Ordering Party if the proprietary rights and copyrights to those Documents are retained by Hofmann & Vratny.

2. All orders for Goods placed by the Ordering Party shall constitute binding offers. Unless stated otherwise in the respective order, Hofmann & Vratny shall be entitled to accept an offer within two weeks after receipt of said offer.

3. Hofmann & Vratny shall accept offers in writing (e.g., in the form of an order confirmation) or by delivering the respective Goods to the Ordering Party.

4. All proprietary rights and copyrights to Documents shall remain with Hofmann & Vratny. Documents marked as confidential shall be forwarded to third parties only with the express written consent of Hofmann & Vratny.

§ 3 DELIVERY DEADLINES AND DEFAULT OF DELIVERY

1. Delivery deadlines shall be agreed upon by Hofmann & Vratny and the individual Ordering Party or shall be specified by Hofmann & Vratny upon acceptance of the order or in the order confirmation.

2. Hofmann & Vratny’s compliance with delivery obligations shall be conditional upon the Ordering Party’s on-time and proper compliance with the Ordering Party’s obligations including, but not limited to, the provision of the papers, permits and approvals required to be provided by the Ordering Party and the receipt by Hofmann & Vratny of the agreed-upon down payment, if any. In the event of delays, the delivery time shall be extended reasonably.

3. If Hofmann & Vratny is unable to meet any binding delivery deadlines for reasons beyond the control of Hofmann & Vratny (non-availability of services), the Ordering Party shall be notified without undue delay and shall be provided with an estimated new delivery deadline. If the agreed upon Goods do not become available before the new deadline expires, Hofmann & Vratny shall be entitled to rescind the contract in whole or in part and shall reimburse the Ordering Party without undue delay for any and all consideration paid up to that time. For the fulfillment of this clause, non-availability of services shall include, but shall not be limited to, delayed delivery from any of Hofmann & Vratny’s suppliers for reasons beyond the control of Hofmann & Vratny or its suppliers, or if Hofmann & Vratny is not responsible for procuring the Goods.

4. If failure to comply with a delivery deadline is due to an act of God, industrial dispute or other event beyond the control of Hofmann & Vratny, the delivery time shall be extended reasonably. The same shall apply if and when any such act of God, industrial dispute or other event has arisen at any of Hofmann & Vratny’s sub-suppliers which event can be demonstrated to have had an impact on compliance with the delivery deadline. Hofmann & Vratny shall notify the Ordering Party of such circumstances without undue delay. Events also shall be deemed to be beyond Hofmann & Vratny’s control if and when they occur during a delay. In this case, the delay shall be deemed to be suspended for the duration of the respective event.

5. The beginning of a period of delivery default shall be in accordance with the law, but shall in any case require a reminder issued by the Ordering Party.

6. If a contract regarding stand-by delivery has been signed, Hofmann & Vratny shall deliver and invoice the Goods no later than 12 months after the date of such contract (hereinafter referred to as the “Recall Period”), even if the Ordering Party has failed to recall the Goods by that time. After the Recall Period has expired, Hofmann & Vratny can notify the Ordering Party of Hofmann & Vratny’s readiness to deliver and can request that the Ordering Party recall the Goods within a reasonable period of time. If the Ordering Party fails to recall the Goods within such period, Hofmann & Vratny shall be entitled to demand an additional lumpsum compensation for warehousing costs (hereinafter referred to as the “Warehousing Allowance”). The Warehousing Allowance shall be 0.5% of the net value of the purchased Goods for every full week, but shall not exceed 5% of the net value of the purchased Goods in total. The Ordering Party shall be free to prove that Hofmann & Vratny did not incur any damages or that any damages incurred were lower than the Warehousing Allowance. If the Ordering Party fails to recall the Goods within the Recall Period determined by Hofmann & Vratny, Hofmann & Vratny shall be entitled to dispose of the Goods as Hofmann & Vratny sees fit. The statutory provisions regarding rescission shall remain unaffected.

§ 4 DELIVERY AND DEFAULT OF ACCEPTANCE

1. Unless agreed upon otherwise, all deliveries shall be ex works, that is, the

place of performance for deliveries and for all subsequent actions. Unless agreed upon otherwise, upon request and at the expense of the Ordering Party the Goods shall be delivered to another destination (hereinafter referred to as “Sales Involving the Carriage of Goods”). Unless agreed upon otherwise, Hofmann & Vratny shall be entitled to determine the shipment method (including, but not limited to, the forwarder, the type of shipment and the packaging).

2. Partial deliveries shall be admissible, provided the Ordering Party reasonably can be expected to accept them.

3. Delivered Goods shall be accepted by the Ordering Party even if the delivered Goods have minor defects provided the Ordering Party reasonably can be expected to accept such Goods.

4. The risk of accidental destruction and/or deterioration of the Goods shall transfer to the Ordering Party no later than upon surrender of the Goods. In the case of Sales Involving the Carriage of Goods, the risk of accidental destruction and/or deterioration of the Goods and the risk of delay shall transfer to the Ordering Party no later than at the time of delivery of the Goods to the forwarder, carrier, or any other person designated to execute shipment of the Goods. Delivery shall be deemed to have been effected even if the Ordering Party is in default of acceptance.

5. If the Ordering Party is in default of acceptance or fails to cooperate or if delivery is delayed for other reasons for which the Ordering Party is responsible, Hofmann & Vratny shall be entitled to demand reimbursement for the damages incurred in connection therewith including additional expenses (e.g., warehousing costs).

§ 5 TERMS OF PAYMENT

1. Unless agreed upon otherwise in individual cases, Hofmann & Vratny’s prices plus statutory sales tax valid at the time the contract is signed shall apply. The prices indicated in Hofmann & Vratny’s catalogs are non-binding and subject to change and/ or correction.

2. Unless agreed upon otherwise, in the case of Sales Involving the Carriage of Goods the Ordering Party shall bear the costs of packaging and transportation ex works and the costs, if any, for transportation insurance if such insurance is requested by the Ordering Party. All customs and other fees, taxes and other public charges also shall be borne by the Ordering Party unless agreed upon otherwise. Ownership of the packaging for transportation and otherwise pursuant to the Verpackungsordnung (Packaging Ordinance of Germany) shall transfer to the Ordering Party and such packaging shall not be returned to Hofmann & Vratny. Pallets shall be exempt from this rule.

3. Unless agreed upon otherwise in the order confirmation, the purchase price plus statutory sales tax shall be due and payable without any deductions within 14 days after the date of invoicing and delivery or acceptance of the Goods. However, Hofmann & Vratny reserves the right to make full or partial deliveries against cash in advance at any time including during an ongoing business relationship. The assertion of such right shall be communicated no later than at the time the order confirmation is issued. The Ordering Party shall be deemed to be in default of payment upon the expiration of the aforementioned payment deadline. The applicable rate of interest on the purchase price of the Goods shall become payable during the default period. The right to assert claims for more substantial compensation shall be reserved. Hofmann & Vratny’s right to claim commercial-rate default interest (§ 353 of the HGB) shall remain unaffected.

4. The Ordering Party’s rights of set-off and retention shall be limited to the extent the Ordering Party’s claim is determined in a court of law or is undisputed. The Ordering Party’s rights based on defects in the purchased Goods (see § 7 hereof) shall remain unaffected.

5. After the contract has been signed, if there is evidence that Hofmann & Vratny’s claim to the purchase price will be compromised due to lack of performance on the part of the Ordering Party, Hofmann & Vratny shall be entitled to refuse performance pursuant to the applicable laws and, after setting a deadline, if applicable, shall be entitled to rescind the contract. In the case of contracts regarding the production of customized items, Hofmann & Vratny shall be entitled to rescind the contract immediately and the laws regarding the expendability of setting deadlines shall remain unaffected.

§ 6 RETENTION OF TITLE

1. Until all pending and future receivables in connection with the business relationship between Hofmann & Vratny and the Ordering Party are paid in full, Hofmann & Vratny shall retain ownership of the Goods. If the Ordering Party violates the contract including, but not limited to, default of payment, Hofmann & Vratny shall be entitled to rescind the contract pursuant to the applicable laws and to demand the surrender of the Goods.

2. Goods subject to retention of title shall not be pledged or assigned as collateral before the Ordering Party has paid in full. The Ordering Party shall notify Hofmann & Vratny in writing without undue delay in the event of a filing for commencement of insolvency proceedings or if third parties gain access (e.g., seizures) to Goods belonging to Hofmann & Vratny.

3. If the Ordering Party violates the contract including, but not limited to, by failing to pay the purchase price when due, Hofmann & Vratny shall be entitled to rescind the contract pursuant to the applicable laws and to demand the surrender of the Goods due to the retention of title and the rescission.

4. Until further notice, the Ordering Party shall be entitled to resell/and or process in the ordinary course of business any Goods subject to retention of title. In this case, the provisions below also shall apply.

a) The retention of title shall include title to the full value of work products resulting from processing, mixing or combining the Goods, in which case Hofmann & Vratny shall be deemed to be the manufacturer. If and when third-party goods are processed, mixed or combined and such third parties retain ownership, Hofmann & Vratny shall acquire coownership pro rata of the invoiced value of work products so processed, mixed or combined. In all other cases, the creation of work products shall be subject to the same provisions as the delivered Goods subject to retention of title.

b) The Ordering Party hereby agrees to assign to Hofmann & Vratny as collateral any and all receivables against third parties resulting from the resale of the Goods or work results in full or in the amount of Hofmann & Vratny’s estimated share of co-ownership pursuant to a) above, and Hofmann & Vratny hereby accepts such assignment. The Ordering Party’s obligations under § 6 2) hereof also shall apply with respect to the receivables assigned.

c) In addition to Hofmann & Vratny, the Ordering Party shall remain authorized to collect receivables. Hofmann & Vratny undertakes to refrain from collecting receivables as long as the Ordering Party meets its payment obligations vis-à-vis Hofmann & Vratny and does not fail to perform and Hofmann & Vratny does not assert its retention of title by asserting a right under § 6 3) hereof. Otherwise, Hofmann & Vratny shall be entitled to demand that the Ordering Party inform Hofmann & Vratny of such receivables assigned and of the names of the debtors, provide Hofmann & Vratny with all the information required for collecting such receivables and the pertinent documents, and inform the debtors (third parties) of the assignment. In addition, in this case Hofmann & Vratny shall be entitled to revoke the Ordering Party’s authorization to resell and/or process Goods which are subject to retention of title.

5. Upon request of the Ordering Party, Hofmann & Vratny shall release the collateral to which Hofmann & Vratny is entitled insofar as the realizable value of such collateral exceeds the receivables to be collateralized by more than 10 percent. Hofmann & Vratny shall be free in its decision regarding which collateral to release.

§ 7 LIABILITY FOR DEFECTS AND CLAIMS FOR DEFECTS

1. Unless otherwise agreed upon herein, the Ordering Party’s rights based on defects in quality and/or in title (including delivery of the wrong Goods or insufficient amounts, improper assembly/installation, or incomplete instructions) shall be subject to the applicable laws. The special legal stipulations regarding reimbursement of expenses at the time of delivery of newly produced Goods (supplier’s recourse as specified in §§ 478, 445a, 445b and §§ 445c, 327 para. 5, 327u of the BGB) shall remain unaffected in any case, unless equal-value compensation has been agreed upon, for example, as part of a quality assurance agreement.

2. Hofmann & Vratny’s liability for defects shall be based first and foremost on the respective agreement entered into regarding the quality and the posulated use of the Goods (including fittings and instructions). In this context,

an agreement regarding the quality of Goods shall be any and all product descriptions and manufacturer-provided information outlined in the individual agreement or made publicly known by Hofmann & Vratny (including, but not limited to, in catalogs or on Hofmann & Vratny's internet homepage) at the time the contract was signed. However, if and when no agreement regarding quality has been entered into, the presence or absence of a defect shall be determined based on the legal regulations (§ 434 para. 3 of the BGB). Statements made publicly by the manufacturer or on the manufacturer's behalf including, but not limited to, in advertising materials or on labels on the Goods shall prevail over other third parties' statements. In the case of Goods comprising digital elements or other digital content, Hofmann & Vratny shall be responsible for providing and, if required, updating the digital content only if defined expressly in an agreement regarding the quality of Goods, as stipulated above. Hofmann & Vratny shall not assume any liability for public statements made by the manufacturer or other third parties.

3. Hofmann & Vratny shall not assume liability for any defects of which the Ordering Party is aware, or for any defects of which the Ordering Party is grossly negligent if it is not aware (§ 442 of the BGB) at time the contract is signed. The assertion of claims by the Ordering Party regarding defects shall be conditional upon the Ordering Party's meeting of its statutory duty to inspect and to give notice of defects (§§ 377 and 381 of the HGB (Commercial Code of Germany)). If a defect in the Goods becomes apparent during or after inspection, the Ordering Party shall give written notice to Hofmann & Vratny without undue delay. Regardless of the Ordering Party's duty to inspect and to give notice of defects, the Ordering Party shall give written notice of obvious defects within two weeks after delivery, which notice shall be deemed to have been given in a timely manner if it is transmitted before the end of such period. If the Ordering Party fails to inspect the Goods properly and/or to give proper notice of any defects, Hofmann & Vratny shall not assume liability for any defects for which no notice was given.

4. If any of the Goods are defective, Hofmann & Vratny shall be free to offer supplementary action to remedy the defect or defects (supplementary remedy) or to deliver defect-free Goods (replacement) to the Ordering Party. In individual cases, the Ordering Party may refuse a supplementary action selected by Hofmann & Vratny that the Ordering Party considers to be unreasonable. It is Hofmann & Vratny's right to refuse to offer supplementary action under the applicable laws shall remain unaffected. The requirement for Hofmann & Vratny to provide any supplementary action owed shall be conditional upon the Ordering Party's paying of the purchase price when due. However, the Ordering Party shall be entitled to retain a reasonable portion of the purchase price pro rata in consideration of the defect. The Ordering Party shall give Hofmann & Vratny the time and the opportunity to provide the supplementary action owed including, but not limited to, providing Hofmann & Vratny the opportunity to inspect the Goods which are subject to complaint. If Hofmann & Vratny opts to replace the Goods, at Hofmann & Vratny's request the Ordering Party shall return the defective Goods to Hofmann & Vratny in accordance with the applicable laws; however, the Ordering Party shall not have the right to request to return the defective Goods. Supplementary action shall not include the disassembly, removal, or de-installation of defective Goods nor the assembly, mounting, or installation of defect-free Goods, provided Hofmann & Vratny was not originally obligated to provide such services; any rights the Ordering Party may have to be reimbursed for such costs (hereinafter referred to as "Disassembly and Assembly Costs") shall remain unaffected.

5. If in fact a defect is present, any and all expenses incurred in connection with inspections and supplementary action including, but not limited to, transportation, road, labor and material costs, and Disassembly and Assembly Costs shall be borne by Hofmann & Vratny in accordance with the laws and these General Terms of Sale. However, if the Ordering Party's demand for remedy of a defect is proven to be invalid because the Ordering Party was aware or was grossly negligent if it was not aware that no defect actually was present, Hofmann & Vratny can demand reimbursement from the Ordering Party for any costs incurred therewith. If the costs of supplementary remedy would be disproportionately high, the Ordering Party shall not be entitled to claim remedy of defects.

6. If and when a reasonable deadline for supplementary action set by the buyer has expired unsuccessfully or can be disregarded under the law, the Ordering Party can rescind the purchasing contract in accordance with the law or reduce the purchase price. However, no right to rescind shall apply in the case of insignificant defects.

7. The Ordering Party's claims for damages or reimbursement for wasted expenses shall be limited by the provisions of § 8 below and shall be excluded in all other cases.

8. The statute of limitations for claims for defects in quality and in title shall be one year after delivery of the Goods. The statute of limitations shall commence upon delivery of the Goods provided acceptance has been agreed upon. Other special legal stipulations regarding statutes of limitations (including, but not limited to, § 438 para. 1 no. 1, no. 2, para. 3, §§ 444, 445b of the BGB) shall remain unaffected. The aforementioned statutes of limitations specified in the purchasing laws also shall apply to any contractual and extra-contractual claims for reimbursement made by the Ordering Party based on a defect in the Goods, unless applying the regular statute of limitations stipulated by law (§§ 195, 199 of the BGB) would result in a reduced statute of limitations in individual cases. Any claims for reimbursement the Ordering Party may have pursuant to § 8 para. 2 p. 1 and p. 2 (a) and pursuant to the Produkthaftungsgesetz (Product Liability Act of Germany) shall be subject exclusively to the statutes of limitations stipulated by law.

§ 8 OTHER LIABILITIES

1. Unless agreed upon otherwise in these General Terms of Sale and in the provisions below, Hofmann & Vratny's liability for breach of contractual and non-contractual obligations shall be in accordance with the applicable laws.

2. Hofmann & Vratny's liability for damages, regardless of the legal reasons and of whether or not they are known, as part of Verschuldenshaftung (liability arising from damage caused by negligent act) shall include intent and gross negligence. Subject to the limitations of liability stipulated by law (e.g., diligence with its own affairs, insignificant breach of duty), in the event of minor negligence Hofmann & Vratny's liability shall be limited to (a) damages resulting from harm to life, body or health and/or (b) damages resulting from the not-insignificant breach of a material contractual obligation, that is, an obligation which must be met to make the proper fulfillment of the contract possible and the meeting of which the Ordering Party relies upon and can rely upon on a regular basis. In this case, however, Hofmann & Vratny's liability shall be limited to reimbursement of the foreseeable damages typical in such cases.

3. The limitation of liability specified above also shall apply vis-à-vis third parties and in the event of a breach of duty by any person (including to his/her own benefit) for which Hofmann & Vratny is responsible by law; however, it shall not apply if and when Hofmann & Vratny is found to have failed to disclose a defect maliciously or has assumed a guarantee for the quality of the Goods and for the Ordering Party's claims under the Produkthaftungsgesetz.

4. The Ordering Party can rescind or cancel a contract due to a breach of obligation other than a breach based on a defect only if and when Hofmann & Vratny is responsible for such breach of obligation. The Ordering Party shall not have an unrestricted right to terminate a contract. All other cases shall be subject to the applicable laws and legal consequences.

§ 9 APPLICABLE LAW AND JURISDICTION

1. These General Terms of Sale and all legal relationships between Hofmann & Vratny and the Ordering Party shall be subject to the laws of the Federal Republic of Germany under exclusion of the provisions of uniform international law. The CISG shall not apply.

2. Any and all disputes arising directly or indirectly from the contractual relationship shall be subject exclusively, including at an international level, to the jurisdiction of Aßling if the Ordering Party is a businessperson as defined in the Handelsgesetzbuch (Commercial Code of Germany), a legal entity under public law, or a special fund under public law. The same shall apply if the Ordering Party is an entrepreneur pursuant to §§ 14 of the BGB. However, in any case Hofmann & Vratny shall be entitled to sue the Ordering Party at the place of performance of the obligation to deliver under these General Terms of Sale and/or under a prevailing individual agreement or at the Ordering Party's general jurisdiction. Prevailing legal regulations including, but not limited to, regarding exclusive jurisdictions, shall remain unaffected.

Hofmann & Vratny OHG
June 2022

CONTACT HOFMANN & VRATNY

Hofmann & Vratny OHG - Headquarters

Steinkirchen 4½

85617 Aßling

Telephone: +49 80 92 / 85 333-0

E-Mail: info@vhmhv.de

Hofmann & Vratny OHG - Regrinding centre

Poststr. 15a

90471 Nürnberg

Telephone: +49 80 92 / 85 333-152

E-Mail: nbg@vhmhv.de

A RELIABLE PARTNER

DISCOVER OUR H&V PRODUCT RANGE.

Our goal is to provide companies around the world with the best tools.

We are constantly developing our product portfolio. We experiment with new geometries, coatings and materials at our research and development center to make the right milling cutter for every application.

SCAN THE QR CODE NOW



EXPERT | Non-ferrous materials



EXPERT | Steel & cast iron



EXPERT | Titanium

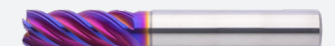

EXPERT | Hardened steel

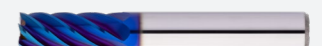

BASIC | Universal



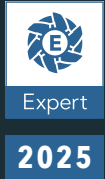

EN

HOFMANN & VRATNY EXM1 SERIES - EXPERTS IN CUTTING STAINLESS STEEL

Hofmann & Vratny OHG
Steinkirchen 4½
85617 Aßling

Telephone: +49 80 92 / 85 333-0
E-Mail: info@vhmhv.de
Web: www.vhmhv.de



OFFICIAL PARTNER OF H&V

